



2021



# www.vignal-group.com



Photos à 360°  
360° pictures  
360° Fotos



Fiches produits détaillées  
Detailed product sheets  
Detaillierte Produktblätter



Centre de téléchargement  
Download center  
Download-Center



Aide questions produits  
Product questions help  
Produktfragen helfen



PRODUITS D'ORIGINE CONSTRUCTEURS  
 OE SPARE PARTS PER MANUFACTURER  
 ORIGINALERSATZTEILE NACH FAHRZEUGHERSTELLER

ASCA.....	8
BENALU.....	12
BOBCAT.....	14
CASE.....	16
CATERPILLAR.....	17
CHEREAU.....	19
CLAAS.....	22
DAF.....	23
DE BUF.....	28
DOOSAN.....	30
FELDBINDER.....	32
FIAT.....	34
FRUEHAUF.....	35
GUILLEN.....	37
HEULIEZ.....	39
HYUNDAI CONSTRUCTION EQUIPMENT.....	41
IVECO.....	43
IVECO BUS.....	54
KUBOTA.....	60
LAMBERET.....	61
LECAPITAINE.....	65
LECIÑENA.....	66
LINDE.....	68
MAGYAR.....	69
MAN.....	70
MANITOU.....	73
MANITOWOC.....	75
MERCEDES.....	76
MERLO.....	79
NEW HOLLAND.....	80
NISSAN.....	81
OMEPS.....	82
OPEL.....	84
PEUGEOT CITROËN.....	85
RENAULT TRUCKS.....	86
SAME.....	114
SCANIA.....	115
SCHMITZ.....	117
SOR IBERICA.....	119
STEYR.....	121
STILL.....	122
TROUILLET.....	123
UD TRUCKS.....	124
VF VENIERI.....	125
VOLKSWAGEN.....	126
VOLVO.....	127
VOLVO CONSTRUCTION BUS.....	136

## **SIGNALISATION - SIGNALLING - SIGNALISIERUNG**

---

Feux arriere - Rear lamps - Heckleuchten.....	137
Eclaireurs de plaque - Number plate lamps - Kennzeichenleuchten .....	178
Feux clignotants - Flasher lamps - Fahrtrichtungsanzeiger .....	182
Feux de position- Position lamps - Positionsleuchten.....	189
Feux de gabarits - End outline marker lamps - Begrenzungsleuchten.....	206
Signalisation passive - Warning products - Warnmarkierungen.....	213

## **ECLAIRAGE - LIGHTING - BELEUCHTUNG**

---

Phares de recul - Reverse work lights - Rückfahrlicht Arbeitsscheinwerfer .....	218
Phares de travail - Work Lights - Arbeitsscheinwerfer.....	221
Éclairage de sécurité - Warning Lights - Sicherheitsbeleuchtungen .....	238
Phares de conduite - Headlights - Fahrlichter .....	240
Feux auxiliaire - Auxiliary Lights - Zusatzsscheinwerfer.....	245
Éclairage intérieur - interior Lights - innenraum-Beleuchtungen.....	248

## **PRODUITS DE SÉCURITÉ - SAFETY PRODUCTS - SICHERHEITSPRODUKT**

---

Gyrophares - Beacons - Rundumkennleuchten.....	251
Rampes lumineuses - Lightbars - Warnbalken .....	264
Triflash.....	268
Feux de pénétration - Directional light - Warnleuchten .....	271
Alarmes sonores de recul - Back up alarms - Rückfahrwarner .....	273
Systèmes caméras - Camera systems - Kamera-Systeme .....	275
Coffres porte extincteur - Extinguisher boxes - Feuerlöscher Behälter .....	291

## **ÉLECTRIQUE-ÉLECTRONIQUE - ELECTRICAL-ELECTRONICS - ELEKTRISCH-ELEKTRONISCHE**

---

Prises et câbles spiralés - Plugs and coils - Stecker und Spiralkabel.....	293
Connecteurs - Connectors - Anschlussstecker.....	299
Faisceaux - Harnesses - Kabelsatz.....	304
Systèmes câblage et feux - Wiring and lamps systems - Verkabelung und leuchten systeme .....	313

## **RECHERCHE PRODUITS - PRODUCTS RESEARCH - PRODUKTSUCHE**

Par liste de correspondance - By cross list - nach Hersteller-Nr .....	319
Par référence - By part number - nach Artikelnummer .....	323
Par no. d'homologation - By homologation number - nach Homologationsnummer .....	327
Par photo - By pictures - nach Abbildung .....	328

Ce catalogue n'est pas contractuel  
This catalogue does not create any contractual tie  
Die Informationen in diesem Katalog sind nicht bindend !  
Wir behalten uns ausdrücklich vor, eventuelle Prospektangaben zu ändern

## Vignal Group, le spécialiste de l'éclairage et de la sécurité pour véhicules industriels et commerciaux.

Vignal Group, the lighting and safety specialist for industrial and commercial vehicles.

Vignal Group, der Beleuchtungs- und Sicherheitspezialist für Industrie- und Nutzfahrzeuge.



Un savoir faire unique  
A unique know-how  
Ein einzigartiges Fachwissen



Des produits de qualité  
Quality products  
Detaillierte Produktblätter



Des années d'expertise  
Years of expertise  
Langjährige Erfahrung



# Des marques validées par les constructeurs.

OE approved brands.

Vom Fahrzeughersteller validierte Marken.



Notre philosophie est de concevoir globalement et de produire localement. Nos 5 sites sont présents sur trois continents pour vous offrir la meilleure flexibilité pour le meilleur service possible.

Our philosophy is to have a global design for a local production. Our 5 sites are located on three continents to offer you more flexibility for a better service.

Unsere Philosophie ist es, global zu designen und lokal zu produzieren. Unsere 5 Standorte befinden sich auf drei Kontinenten, um Ihnen die bestmögliche Flexibilität und den bestmöglichen Service zu bieten.



## Vignal a fait du développement durable l'un de ses axes stratégiques majeurs.

Vignal has turned sustainable development into one of its main strategic focus.

Vignal hat die nachhaltige Entwicklung zu einem seiner strategischen Hauptschwerpunkte gemacht.



# SECTEURS INDUSTRIES BRANCHEN



# Produits d'origine constructeurs

## OE spare parts per manufacturer

### Originalersatzteile Fahrzeughersteller



**K** Catadioptr  
Reflector  
Rückstrahler

**T** Catadioptr triangulaire  
Triangular reflector  
Dreieckrückstrahler

**FPL** Feu de position latéral  
Side marker lamp  
seitenmarkierungsleuchte

**EPP** Eclaireur de plaque  
Number plate lamp  
Kennzeichenleuchte

**Al** Alarme sonore de recul  
Back up alarm  
Rückfahrhorn

**CC** Connecteurs additionnels  
Additional connectors  
Zusätzliche elektrische anschlüsse

**AMP 1.5-7P-M**



08/2020 ->



p. 154

Type connecteur - Nb pins - Mâle ou Femelle  
Connector type - Pins Nb - Male or Female  
Steckertyp - Stifte Nb - männlich oder weiblich

Flashez le QR code pour plus d'infos  
Scan the QR code for more info  
Scannen Sie den QR-Code für weitere Informationen

Pièces détachées  
Spare parts  
Ersatzteile

Dates d'application  
Application dates  
Baujahr

Numéro page produit standard  
Standard product page number  
Standardproduktseitennummer



Faisceau p. 299  
Harness p. 299  
Anschlusskabel siehe S. 299

DETAL CONNECTEUR 1.5	Nombre des Pinces dans le connecteur	POSITION Pinces	FONCTION
	1	WASSE	STOP
	2	POSITION	TOUR
	3	REDA	TOUR
	4	INDICATEUR DE DIRECTION	INDICATEUR
	5	STOP	INDICATEUR
	6	MODULARE	
	7	NOT USED	

Pinning connecteurs sur notre site web  
Connectors pinning on our website  
Anschlüsse feststecken auf unsere Website



## LC12T LED

 p. 138

**LED**

 24V



**161000**

gauche - left - links



**AMP 1.5-7P-M**

arrière  
rear connector  
Anschlusstecker hinten



**161010**

droit - right - rechts



**D11868**

**AMP 1.5-7P-F**

## LC8T

 p. 157



**156040**

gauche - left - links



**AMP 1.5-7P-M**

arrière  
rear connector  
Anschlusstecker hinten



**156050**

droit - right - rechts



**156060**

gauche - left - links



**D11868**

**AMP 1.5-7P-F**



**056700**

gauche - left - links



**056710**

droit - right - rechts



LC5TDX ⓘ p.165



**153660**

gauche - left - links



**AMP 1.5-7P-M**

arrière  
rear connector  
Anschlussstecker hinten



**153670**

droit - right - rechts



**D11868**

**AMP 1.5-7P-F**



**053700**

gauche - left - links

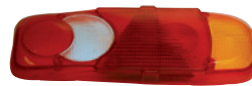

**053710**

droit - right - rechts



LC5T ⓘ p.164



**153000**

gauche - left - links



**AMP 1.5-7P-M**

arrière  
rear connector  
Anschlussstecker hinten



**153010**

droit - right - rechts



**153020**

gauche - left - links



**D11868**

**AMP 1.5-7P-F**



**053700**

gauche - left - links



**053710**

droit - right - rechts



EPP96 ⓘ p.181



**D10502**

410 mm

**CLICK-IN**

## EPP96 LED p. 180

LED

 24V



**D13609** 400 mm  
**CLICK-IN**

## FE04 p. 190

LED

 24V



**104310** 5000 mm

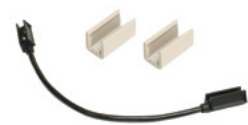

**D10132** 200 mm

## SMD98 p. 191

LED

 24V



**D11399** 1500 mm **K**  
**CLICK-IN**



**001716**

## SMD04 p. 196

LED

 24V



**104140** 1500 mm **K**  
**CLICK-IN**



**104100** 1500 mm **K**  
**CLICK-IN**



**104260** 1500 mm **K**  
**CLICK-IN**



**104220** 1500 mm **K**  
**CLICK-IN**

**DXLC8** ⓘ p. 158



**D13034**

gauche - left - links

CLICK-IN



**D13035**

droit - right - rechts

CLICK-IN

**DX** ⓘ p. 209



**D12428**

W5W

1400 mm

CLICK-IN

**FA3LED** ⓘ p. 207

LED



12/24V



**D14427**

gauche - left - links

1500 mm

CLICK-IN



**D14428**

droit - right - rechts

1500 mm

CLICK-IN

**MDJ** ⓘ p. 145



**175020**

# BENALU

## LC12 LED p. 138

**LED**

 24V



**161000**

gauche - left - links



**AMP 1.5-7P-M**

arrière  
rear connector  
Anschlusstecker hinten



**161010**

droit - right - rechts



## LC8T p. 157



**156040**

gauche - left - links



**AMP 1.5-7P-M**

arrière  
rear connector  
Anschlusstecker hinten



**156050**

droit - right - rechts



**D11868**

**AMP 1.5-7P-F**



**056700**

gauche - left - links



**056710**

droit - right - rechts



**001830**



## SMD04 p. 196

**LED**

 24V



**104140**

1500 mm



**CLICK-IN**



**104090**

500 mm



**104100**

1500 mm



**CLICK-IN**



**104260**

1500 mm



**CLICK-IN**



**104640**

300 mm



**104650**

1000 mm



bride rallongée - extended bracket - Montagewinkel verlängerter

**CLICK-IN**

## SMD98 p.191

**LED**

 24V



**D11399** 1500 mm

**CLICK-IN**



**001716**

## DXLC8 p.158



**D12712**

gauche - left - links

**POS-2P-F**



**D12711**

droit - right - rechts

**POS-2P-F**

## ASR p.274

 12/24V

Multi-Frequency



**D13810**

1500 mm

97 dB



**CLICK-IN**

Standard



**630120**

87 dB



## MDJ p.145



**175020**

### LC12 LED



p. 138

LED



12V



**D161140**  
(OE 7322387)

gauche - left - links



AMP 1.5-7P-M

arrière  
rear connector  
Anschlussstecker hinten



**D161150**  
(OE 7322388)

droit - right - rechts



**D11868** AMP 1.5-7P-F

### CHL 1 LED



p. 242

LED



12V



**D14324**  
(OE 7348957)

gauche - left - links

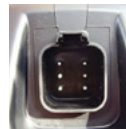

DT-6P-M

arrière  
rear connector  
Anschlussstecker hinten



**D14325**  
(OE 7348958)

droit - right - rechts



**D14352** DT-6P-F

### RL 1500



p. 225

LED



12/24V



1500 Lumen



**D14854**  
(OE 7387145)

DT-2P-M



**D14170** DT-2P-F

## TELESCOPIC

### GALAXY LED

 p. 255

LED

 12/24V



**D14488**  
(OE 7322390)



**D14513**

## TL470, MF9000

### LC5

 p. 161



**152150**  
(OE 7164111)  
gauche - left - links



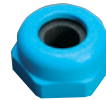

PG  
arrière  
rear connector  
Anschlusstecker hinten



**152150**  
(OE 7164110)  
droit - right - rechts





**052500**  
(OE 7027476)  
gauche - left - links





**052500**  
(OE 7027476)  
droit - right - rechts





**R12931** - 1200 mm  
(OE 7028786)





**R12934** - 600 mm  
(OE 7028787)



## EPP98

 p. 181



**196010**  
(OE 7175124)





**D13876**





## LPL18

 p. 179

**LED**

 12/24V

08/2020 ->

**NEW**



**199000**  
(OE 47363002)

**SS-2P-M**



**D13880**

**SS-2P-F**

## SMD98

 p.197

**LED**

 12V

08/2018->



**198810**  
(OE 5141966)

**SS-2P-M**



**D13880**

**SS-2P-F**

## SH3

 p. 236

 H3/70W  
12V

08/2018 ->



**D14156**

**DT-2P-M**



**D14170**

**DT-2P-F**

## FT

 p. 234

**LED**

 12/24V

07/2017 ->



**D14191**  
(OE 47826594)



**D14192**

## SL 1000 p.222

LED

 12/24V

 1000 Lumen



**D14850**

DT-2P-M



**D14170**

DT-2P-F

## SL 1500 p.223

LED

 12/24V

 1500 Lumen



**D14851**

DT-2P-M



**D14170**

DT-2P-F

## SLA 2000 p.223

LED

 12/24V

 2000 Lumen



**D14852**

DT-2P-M



**D14170**

DT-2P-F

## RL 1000 p.225

LED

 12/24V

 1000 Lumen



**D14853**

DT-2P-M



**D14170**

DT-2P-F

## RL 1500 p.225

**LED**

 12/24V

 1500 Lumen



**D14854**

**DT-2P-M**



**D14170**

**DT-2P-F**

## RLA 2000 p.225

**LED**

 12/24V

 2000 Lumen



**D14855**

**DT-2P-M**



**D14170**

**DT-2P-F**

## SH3 p.236

 H3/70W  
24V



**D14156**

**DT-2P-M**



**D14170**

**DT-2P-F**

## RH3 p.236

 H3/70W  
24V



**D14654**

**DT-2P-M**



**D14170**

**DT-2P-F**

## BL15-CTL15 p. 145

LED

 24V



Exemple de montage - Assembly suggestion - Montagebeispiel



DT04-4P-M



**164000**  
(OE 21153)



DT04-4P-M



DTM04-4P-M



**164010**  
(OE 21154)

Pour raccordement sur feu BL15  
To plug in BL15 lamp  
Zum direkten Anschluss an die leuchte BL15



**165020**  
(OE 21781)

gauche - left - links



DT04-4P-M



DTM06-4S-4P-F



**165030**  
(OE 21155)

droit - right - rechts



**D14436** DT06-4S-4P-F



**D14437** DTM06-4S-4P-F



**D14435** DTM04-4P-M

## LC12 LED p. 138

LED

 24V

**NEW**



**161000**

gauche - left - links



**AMP 1.5-7P-M**  
arrière  
rear connector  
Anschlussstecker hinten

**NEW**



**161010**

droit - right - rechts



**D11868** AMP 1.5-7P-F

## LC8T

 p. 157



**156040**

gauche - left - links



**AMP 1.5-7P-M**

arrière  
rear connector  
Anschlusstecker hinten



**156050**

droit - right - rechts



**156060**

gauche - left - links



**156070**

droit - right - rechts



**D11868**

**AMP 1.5-7P-F**



**056700**

gauche - left - links



**056710**

droit - right - rechts



## LC8

 p. 154



**156550**

gauche - left - links



**AMP 1.5-7P-M**

arrière  
rear connector  
Anschlusstecker hinten

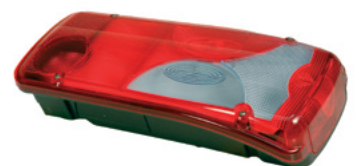

**156540**

droit - right - rechts



**D11868**

**AMP 1.5-7P-F**

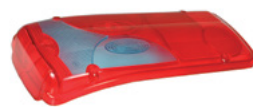

**056000**

gauche - left - links

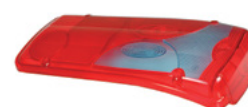

**056010**

droit - right - rechts



**001846**

## LC5T p. 164



**153020**

gauche - left - links



**AMP 1.5-7P-M**

arrière  
rear connector  
Anschlusstecker hinten



**153010**

droit - right - rechts



**D11868**

**AMP 1.5-7P-F**



**053700**

gauche - left - links

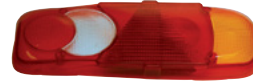

**053710**

droit - right - rechts



## EPP96 p. 181



**196020**

R10W

## SL 1000 p. 219

**LED**

 12/24V

 **R23**



**D14857**

**DT-2P-M**

Feu homologué recul - Homologated reverse lamp -  
Genehmigt Rückfahrleuchte



**D14170**

**DT-2P-F**

09/2019 ->

**NEW**



9/32V



**212400**  
(OE 27108471)



**196020**  
(OE 7700027564)

04/2012 ->



**155100**  
(OE 1875577)     
gauche - left - links



**HDSCS-8P-M**  
latéral  
side connector  
Anschlusstecker seitlich



**155110**  
(OE 1875576)    
droit - right - rechts



Entraxe : 160 mm  
Bolt distance : 160 mm  
Schraubenabstand : 160 mm



**155120**  
(OE 1875578)     
droit - right - rechts

04/2012 ->



**155130**  
(OE 1875580)     
gauche - left - links



**HDSCS-8P-M**  
arrière  
rear connector  
Anschlusstecker hinten



**155140**  
(OE 1875579)    
droit - right - rechts



**155150**  
(OE 1875581)     
droit - right - rechts



**D13878** **HDSCS-8P-F**



**055020**  
(OE 1914690)   
gauche - left - links



**055030**  
(OE 1914691)   
droit - right - rechts



**001830**  
(OE 1973239)   
Alarme sonore de recul  
Back up alarm  
Rückfahrtsignalhorn



1995 -> 04/ 2012



1995 ->2001



**167640**  
(OE 1284211)  

**168020**  
(OE 1304789)   

gauche - left - links



DAF  
arrière  
rear connector  
Anschlusstecker hinten



**167630**  
(OE 1284212) 

**168010**  
(OE 1304788)  

droit - right - rechts



**168890**  
(OE 1660967)   

droit - right - rechts

2001 -> 04/2012



**169160**  
(OE 1625985)   

gauche - left - links



**AMP 1.5-7P-M**  
latéral  
side connector  
Anschlusstecker seitlich



**169170**  
(OE 1625986)  

droit - right - rechts



**169380**  
(OE 1660968)   

droit - right - rechts



**D11868** **AMP 1.5-7P-F**



**067500**  
(OE 1272653) 

gauche - left - links



**067500**  
(OE 1272653) 

droit - right - rechts



**D12953**  
(OE 1519358) 

Alarme sonore de recul  
Back up alarm  
Rückfahrtsignalhorn

1993 ->



**109010**  
(OE 1814096/1815754)

## CF/XF

### ICDL10

 p. 186

01/2013 ->



**117000**  
(OE 1846491)

gauche - left - links



**117010**  
(OE 1846492)

droit - right - rechts



**001619**

## 75 - 85 - XF - CF

### FPL93

 p. 200



**193020**  
(OE 1329718)

**K**

JPT-2P-M

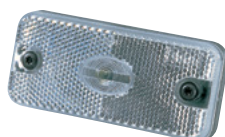

**193200**  
(OE 1653605)

**K**

JPT-2P-M



**001726**  
(OE 1608352)



**D13876**

JPT-2P-F

## LF

### LC5

 p. 161

2001 ->



**152170**  
(OE 1401713)

**K**

**EPP**

gauche - left - links



AMP 1.5-7P-M

arrière  
rear connector  
Anschlusstecker hinten



**152180**  
(OE 1401731)

**K**

droit - right - rechts



**D11868** AMP 1.5-7P-F



**052500**  
(OE 1451482)

**K**

gauche - left - links



**052500**  
(OE 1451482)

**K**

droit - right - rechts

### FE95

 p. 193



**195010**  
(OE 1403887)  
gauche - left - links



**195010**  
(OE 1403887)  
droit - right - rechts

### ICDL94

 p. 187



**119550**  
(OE 1626101)

**JPT-3P-M**



**001616**  
(OE 1626102)



**D13877** **JPT-3P-F**

### FE02

 p. 193



**102200** **K**  
clippé - clipped - befestigung **JPT-2P-M**



**001726**  
(OE 1608352)



**D13876** **JPT-2P-F**

### FPL93

 p. 200



**193020** **K**  
(OE 1329718) **JPT-2P-M**



**001726**  
(OE 1608352)



**D13876** **JPT-2P-F**

### EPP98

 p. 181



**196010**  
(OE 0867930) **JPT-2P-M**



**D13876** **JPT-2P-F**

## 65 - 75 - 85 - 95

### LC4

 p. 171

-> 1993

\* Silent blocs non fournis, voir réf. 001706 p. 170

\* Silent blocs not supplied, see p/n 001706 p. 170

\* Schwingungsdämpfer Art.-Nr. 001706 nicht im Lieferumfang, Seite p. 170



**141500**  
(OE 2922224)  

gauche - left - links



PE  
arrière  
rear connector  
Anschlussstecker hinten



**141500**  
(OE 2922224)  

droit - right - rechts



**040500**  
(OE 0698603) 

gauche - left - links



**040500**  
(OE 0698603) 



droit - right - rechts

### LC7

 p. 166

1993 -> 1995





**168100**  
(OE 1626319/1284213)   

gauche - left - links



DIN  
arrière  
rear connector  
Anschlussstecker hinten



**168390**  
(OE 1626320/1284214)   

droit - right - rechts



**067500**  
(OE 1272653) 

gauche - left - links



**067500**  
(OE 1272653) 

droit - right - rechts

# DE BUF

## LC12 LED p. 138

LED

 24V



**161000**

gauche - left - links



**AMP 1.5-7P-M**  
arrière  
rear connector  
Anschlusstecker hinten



**161010**

droit - right - rechts



**D11868** **AMP 1.5-7P-F**

## SMD04 p. 196

LED

 24V



**104140**

1500 mm



**CLICK-IN**



**104100**

1500 mm



**CLICK-IN**

## FA3 LED p. 207

LED

 12/24V



**D14425**

gauche - left - links

**SS-2P-F**



**D14426**

droit - right - rechts

**SS-2P-F**

## SL 1000 p. 219

LED

 12/24V

 R23



**D14857**

**DT-2P-M**

Feu homologué recul - Homologated reverse lamp -  
Genehmigt Rückfahrleuchte



**D14170**

**DT-2P-F**

## SHD 1200

 p. 227

**LED**

 12/24V



**D14161**

**DT-2P-M**



**D14170**

**DT-2P-F**

## ATLAS

 p. 252

**LED**

 12/24V



**212420**



**D14513**

## EPP96 LED

 p. 180

**LED**

 24V



**R14364**

2000 mm

**SS-2P-F**

## CHL 1 H4

i | p. 243

 24V  
H4 - PY21 - W5W



**D14322**  
gauche - left - links



**DT-6P-M**  
arrière  
rear connector  
Anschlussstecker hinten



**D14323**  
droit - right - rechts



**D14352** **DT-6P-F**

## SL 1500

i | p. 223

**LED**

 12/24V

 1500 Lumen



**D14971** **DT-2P-M**



**D14170** **DT-2P-F**

## SLA 2000

i | p. 223

**LED**

 12/24V

 2000 Lumen



**D14852** **DT-2P-M**



**D14170** **DT-2P-F**

## RH3

i | p. 236

 H3/55W  
12V



**D14654** **DT-2P-M**



**D14170** **DT-2P-F**

## SH3

 p. 236

 H3/70W  
12V



**D14156**

**DT-2P-M**



**D14170**

**DT-2P-F**

## QH3

 p. 236

 H3/70W  
12V



**D14159**

**DT-2P-M**



**D14170**

**DT-2P-F**



# FELDBINDER

## LC12 LED p. 138

**LED**  
24V



**161000**

gauche - left - links



**AMP 1.5-7P-M**

arrière  
rear connector  
Anschlusstecker hinten



**161010**

droit - right - rechts



**D11868**

**AMP 1.5-7P-F**

## LC8T p. 157



**156250**

gauche - left - links



**AMP 1.5-7P-M**

arrière  
rear connector  
Anschlusstecker hinten



**156260**

droit - right - rechts



**D11868**

**AMP 1.5-7P-F**



**056720**

gauche - left - links



**056730**

droit - right - rechts



## SMD04 p. 196

**LED**  
24V



**104140**

1500 mm 

**CLICK-IN**



**104260**

1500 mm 

**CLICK-IN**

## SMD98

 p.197

LED

 24V



**D10500** 500 mm 

**D11399** 1500 mm 

CLICK-IN



**D10497** 500 mm 

CLICK-IN

## FA3 LED p. 207

LED

 12/24V



**D14425**

gauche - left - links

SS-2P-F



**D14426**

droit - right - rechts

SS-2P-F

## DXLC8 p. 158



**D12712**

gauche - left - links

POS-2P-F



**D12711**

droit - right - rechts

POS-2P-F

## ASR p. 274

 12/24V

Standard



**630120**

87 dB



07/2012 ->



Fixation 4 vis M6 (190x60mm)  
Fixing 4 screws M6 (190x60mm)  
Befestigung 4 Schrauben M6  
(190x60mm)



**153270**  
(OE 1372699080)

gauche - left - links





**AMP 1.5-7P-M**

arrière  
rear connector  
Anschlussstecker hinten



**153280**  
(OE 1372698080)

droit - right - rechts





**D11868** **AMP 1.5-7P-F**



**052500**  
gauche - left - links





**052500**  
droit - right - rechts





**193360**  
(OE 1356794080 / 71749250)

**SS-2P-M**





**193170**  
(OE 1305797)

**SS-2P-M**





**001916**



**D13880** **SS-2P-F**

## LC12 LED p. 138



**161000**   
gauche - left - links



**AMP 1.5-7P-M**  
arrière  
rear connector  
Anschlusstecker hinten



**161010**   
droit - right - rechts

## LC8T p. 157



**156040**    
gauche - left - links



**AMP 1.5-7P-M**  
arrière  
rear connector  
Anschlusstecker hinten



**156050**    
droit - right - rechts



**D11868** **AMP 1.5-7P-F**



**056700**   
gauche - left - links



**056710**   
droit - right - rechts



**001830** 

## BL15 p. 171



**NEW**



**165040**  
gauche - left - links



**DT04-4P-M**



**DTM06-4S-4P-F**

**NEW**



**165050**  
droit - right - rechts



**D14436** **DT06-4S-4P-F**



**D14437** **DTM06-4S-4P-F**



**D14435** **DTM04-4P-M**

## EPP96 LED p. 180



**D13609** 400 mm  
**CLICK-IN**

# FRUEHAUF

## EPP96

 p. 181



**196020**

R10W



**D11888**

1000 mm

**CLICK-IN**

## DXLC8

 p. 158



**D12712**

350 mm

gauche - left - links

**POS-2P-F**



**D12711**

350 mm

droit - right - rechts

**POS-2P-F**

## FA3 LED

 p. 207

**LED**

 12/24V



**D14427**

1500 mm

gauche - left - links

**CLICK-IN**



**D14428**

1500 mm

droit - right - rechts

**CLICK-IN**

## SMD04

 p. 196

**LED**

 24V



**104130**

500 mm

**K**

**104140**

1500 mm

**K**

**CLICK-IN**



**104090**

500 mm

**K**

**104100**

1500 mm

**K**

**CLICK-IN**

## 5054

 p. 292



Max 6 kg

**D14538**

## LC12 LED



p. 138

LED

24V



**161000**

gauche - left - links



**AMP 1.5-7P-M**  
arrière  
rear connector  
Anschlusstecker hinten



**161010**

droit - right - rechts



**D11868** **AMP 1.5-7P-F**



**D14781**  
gauche - left - links

**SS-2P-F**



**D14782**  
droit - right - rechts

**SS-2P-F**

## LC8T



p. 157



**156040**

gauche - left - links



**AMP 1.5-7P-M**  
arrière  
rear connector  
Anschlusstecker hinten



**156050**

droit - right - rechts



**056700**  
gauche - left - links



**056710**  
droit - right - rechts



**D12712**  
gauche - left - links

**POS-2P-F**



**D12711**  
droit - right - rechts

**POS-2P-F**



**D11868** **AMP 1.5-7P-F**

## EPP96 LED



p. 180

LED

24V



**R14364**

2000 mm

**SS-2P-F**

# GUILLEN

## EPP96

 p. 181



**D11888**

1000 mm

**CLICK-IN**

## SMD04

 p. 196

**LED**

 24V



**104100**

1500 mm **K**

**CLICK-IN**



**104650**

1000 mm **K**

bride rallongée - extended bracket - Montagewinkel verlängerter

**CLICK-IN**

## SMCU

 p. 196

 12/24V



**D14722**

**SS-2P-M SS-3P-M**

## FA3LED

 p. 207

**LED**

 12/24V



**D14427**

1500 mm

gauche - left - links

**CLICK-IN**



**D14428**

1500 mm

droit - right - rechts

**CLICK-IN**

## GX

### LC6

 p. 170



**166500**





PE  
arrière  
rear connector  
Anschlussstecker hinten



**066500**



cabochon - lens - Lichtscheibe

### LC7

 p. 166



**167150**

(OE 2773801/2870801)



**067000**

(OE 3156201)

cabochon - lens - Lichtscheibe

### FE81

 p. 212



**181000**

(OE 0190408700)



**181050**

(OE 0190552400)

### FE85

 p. 194



**185020**

(OE 5010217022)



**185050**

(OE 5010104837)

### FE95

 p. 193



**195030**

(OE 5010271501)



**195060**

(OE 5010312524)



### FPL93

 p. 200



**193020**  
(OE 190825600)

**K**

**JPT-2P-M**



**001726**



**D13876**

**JPT-2P-F**

### ICDL94

 p. 187



**119550**

**JPT-3P-M**



**001616**



**D13877**

**JPT-3P-F**



**001626**

# HYUNDAI CONSTRUCTION EQUIPMENT

## CHL 1 LED p. 242

LED

 12/24V



**D14324**  
gauche - left - links



**DT-6P-M**  
arrière  
rear connector  
Anschlusstecker hinten



**D14325**  
droit - right - rechts



**D14352** **DT-6P-F**

## CHL 1 H4 p. 243

 24V  
H4 - PY21 - W5W



**D14320** 12V  
**D14322** 24V  
gauche - left - links



**DT-6P-M**  
arrière  
rear connector  
Anschlusstecker hinten



**D14321** 12V  
**D14323** 24V  
droit - right - rechts



**D14352** **DT-6P-F**

## SL 1500 p. 223

LED

 12/24V

 1500 Lumen



**D14971**  
**DT-2P-M**



**D14170** **DT-2P-F**

# HYUNDAI CONSTRUCTION EQUIPMENT

## SH3

 p. 236

 H3/70W  
24V



**D14156**

**DT-2P-M**



**D14170**

**DT-2P-F**

## ATLAS

 p. 252

**LED**

 9/32V



**212460**



## STRALIS / TRAKKER

### LC11

 p. 140

**LED**

 24V

03/2016 ->



**160150**    
(OE 5802062689 / 5802240291)  
gauche - left - links



**HDSCS-8P-M**  
latéral  
side connector  
Anschlussstecker seitlich





**160100**    
(OE 5802000573 / 5802240295)  
droit - right - rechts



**160080**     
(OE 5802000568 / 5802240292)  
gauche - left - links



**160090**     
(OE 5802000767 / 5802240296)  
droit - right - rechts

03/2016 ->



**160110**    
(OE 5802000570 / 5802240293)  
gauche - left - links



**HDSCS-8P-M**  
arrière  
rear connector  
Anschlussstecker hinten



**160130**    
(OE 5802000770 / 5802240297)  
droit - right - rechts



**160140**     
(OE 5802055273 / 5802240294)  
gauche - left - links



**160120**     
(OE 5802000772 / 5802240298)  
droit - right - rechts



**D13878** **HDSCS-8P-F**



**060000**   
gauche - left - links



**060010**   
droit - right - rechts

03/2016 ->



**155450**  
(OE 5801637199)     
gauche - left - links



**HDSCS-8P-M**  
latéral  
side connector  
Anschlusstecker seitlich



**155460**  
(OE 5801637201)    
droit - right - rechts



**155470**  
(OE 5801637202)     
droit - right - rechts

DESIGN EFFET FUMÉ - MÉTALLISÉ  
SMOKED EFFECT & METTALIZED DESIGN  
DESIGN RAUCHEFFEKT - METALLEFFEKT

03/2016 ->



**155480**  
(OE 5801637182)    
gauche - left - links



**HDSCS-8P-M**  
arrière  
rear connector  
Anschlusstecker hinten



**155490**  
(OE 5801757328)    
droit - right - rechts



**155540**  
(OE 5802055272)     
gauche - left - links



**155500**  
(OE 5801757326)     
droit - right - rechts



**D13878** **HDSCS-8P-F**



**055040**   
gauche - left - links



**055050**   
droit - right - rechts



**001830**   
Alarme sonore de recul  
Back up alarm  
Rückfahrhorn

## STRALIS - TRAKKER - EURO CARGO

### LC5

 p.161

06/2011 -> EURO 6



**153220**  
(OE 5801426889)   
gauche - left - links



**AMP 1.5-7P-M**  
arrière  
rear connector  
Anschlussstecker hinten



**153210**  
(OE 5801426894)   
droit - right - rechts



**153200**  
(OE 5801426912)    
gauche - left - links



**153230**  
(OE 5801426917)    
droit - right - rechts



**153240**  
(OE 5801426975)   
gauche - left - links



**153250**  
(OE 5801426977)   
droit - right - rechts

**153260**  
(OE 5801426979)    
droit - right - rechts



**D11868** **AMP 1.5-7P-F**



**052500**  
(OE 42566495)   
gauche - left - links



**052500**  
(OE 42535711)   
droit - right - rechts

### FPL93

 p. 200



**193020**  
(OE 500308514)   
**JPT-2P-M**



**001726**  
(OE 1608352)



**D13876** **JPT-2P-F**

### SMD98

 p. 197

-> 10/2014

 LED

 24V



**198760**  
(OE 5801631615)   
**SS-2P-M**



**D13880** **SS-2P-F**

### LC7

 p. 168

09/2011 -> EURO 6



**169390**  
(OE 5801363428)    
gauche - left - links



**DIN-8P-M**  
arrière  
rear connector  
Anschlussstecker hinten

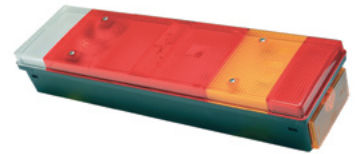



**169410**  
(OE 5801363431)    
droit - right - rechts



**169400**  
(OE 5801363430)     
gauche - left - links



**169420**  
(OE 5801363432)     
droit - right - rechts



**067500**  
(OE 93161844)   
gauche - left - links



**067500**  
(OE 93161844)   
droit - right - rechts



**D12953** 

## STRALIS - TRAKKER - ASTRA HD7/HD8

### C105

 p. 183

09/2012 ->



**110550**  
(OE 5801572024)  
gauche - left - links



**110560**  
(OE 5801572018)  
droit - right - rechts





**001619**

### FPL93

 p. 200



**193170**  
(OE 41200664)   
superseal 



**001916**



**D13880** 

## STRALIS - TRAKKER - ASTRA HD7/HD8

### LC7

 p.167

2002 ->



**168610**  
(OE 99463244)  
gauche - left - links



IVECO  
arrière  
rear connector  
Anschlusstecker hinten



**168600**  
(OE 99463242)  
droit - right - rechts



**168480**  
(OE R504083205)  
droit - right - rechts



**067500**  
(OE 93161844)  
gauche - left - links



**067500**  
(OE 93161844)  
droit - right - rechts



**D12953**



### C199

 p.183

2002 -> 05/2007



**119920**  
(OE 41221041)  
gauche - left - links



**119930**  
(OE 41221040)  
droit - right - rechts

### C105

 p.183

05/2007 -> 09/2012



**110520**  
(OE 42555042)  
gauche - left - links



**110530**  
(OE 42555041)  
droit - right - rechts



**001619**



1996 ->



**168590**  
(OE 99463243)  
gauche - left - links



IVECO  
arrière  
rear connector  
Anschlusstecker hinten



**168600**  
(OE 99463242)  
droit - right - rechts



**168610**  
(OE 99463244)  
gauche - left - links



**067500**  
(OE 93161844)  
gauche - left - links



**067500**  
(OE 93161844)  
droit - right - rechts



06/2008 -> 09/2012



**110520**  
(OE 42555042)  
gauche - left - links



**110530**  
(OE 42555041)  
droit - right - rechts

09/2012 ->



**110550**  
(OE 5801572024)  
gauche - left - links



**110560**  
(OE 5801572018)  
droit - right - rechts



**001619**

## EUROSTAR - EUROTECH - EUROTRAKKER

### LC7

 p.166

1996 -> 2002



**168610**  
(OE 99463244)     
gauche - left - links



IVECO  
arrière  
rear connector  
Anschlusstecker hinten



**168600**  
(OE 99463242)    
droit - right - rechts



**067500**  
(OE 93161844)   
gauche - left - links





**067500**  
(OE 93161844)   
droit - right - rechts

### FPL93

 p.200



**193020**  
(OE 500308514)   



**001726**  
(OE 1608352)



**D13876** 

## MASSIF 4 X 4

### LC5

 p.161

2002 ->



**152180**  
(OE 791123)   
gauche - left - links



**AMP 1.5-7P-M**  
arrière  
rear connector  
Anschlusstecker hinten



**152180**  
(OE 791123)   
droit - right - rechts



**D11868** 



**052500**  
(OE A610067-002)   
gauche - left - links



**052500**  
(OE A610067-002)   
droit - right - rechts

06/2006 ->



**D12334**  
(OE 69500032)  
gauche - left - links



**AMP 1.5-6P-M**  
arrière  
rear connector  
Anschlusstecker hinten



**D12335**  
(OE 69500026)  
droit - right - rechts



**D11868** **AMP 1.5-7P-F**



**D12336**  
(OE 42555132)  
gauche - left - links



**D12337**  
(OE 42555131)  
droit - right - rechts



## 725V

06/2006 ->



**D12338**  
(OE 69500591)

3.5T 

**D12340**  
(OE 69500047)

5T 

gauche - left - links



**D12339**  
(OE 69500590)

3.5T 

**D12341**  
(OE 69500044)

5T 

droit - right - rechts

1999 -> 06/2006



**D11482**  
(OE 500356783)  
gauche - left - links



**AMP 1.5-5P-M**  
arrière  
rear connector  
Anschlusstecker hinten



**D11481**  
(OE 500356782)  
droit - right - rechts



**D11868** **AMP 1.5-7P-F**



**D11480**  
gauche - left - links



**D11479**  
droit - right - rechts



## DAILY

### LC7

 p.167

1996 -> 1999



**168590**  
(OE 99463243)  
gauche - left - links



IVECO  
arrière  
rear connector  
Anschlussstecker hinten



**168600**  
(OE 99463242)  
droit - right - rechts



**067500**  
(OE 93161844)  
gauche - left - links





**067500**  
(OE 93161844)  
droit - right - rechts



## 725

 p.173



**725040**  
gauche - left - links



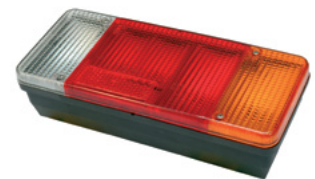

**725010**  
droit - right - rechts





**725002**  
gauche - left - links



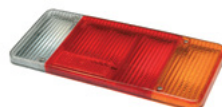

**725012**  
droit - right - rechts



### FPL93

 p. 200

1996 ->



**193020**  
(OE 500308514)

**K**

**JPT-2P-M**



**001726**  
(OE 1608352)



**D13876** **JPT-2P-F**



**193290**  
(OE 504097923)

**K**

**SS-2P-M**



**D13880** **SS-2P-F**

### FE94

 p. 204

1999 ->



**198060**  
(OE 500341613)

**JPT-2P-M**



**D13876** **JPT-2P-F**



**001586**

SEDDON EUROMOVER

LC7

 p.167

1996 -> 1999



**168590**  
(OE 99463243)  
gauche - left - links



IVECO  
arrière  
rear connector  
Anschlussstecker hinten



**168600**  
(OE 99463242)  
droit - right - rechts



**067500**  
(OE 93161844)  
gauche - left - links





**067500**  
(OE 93161844)  
droit - right - rechts



ICDL94

 p.187



**119550**  
(OE 97163920)





**001616**  
(OE 5001834568)



**D13877** 

### ICDL94

 p. 187



**119550**  
(OE 5001020257)

JPT-3P-M



**001616**  
(OE 5001834568)



**D13877**

JPT-3P-F



**001626**  
(OE 5001837993)

### FE95

 p. 193



**195030**  
(OE 5001834505)



**195060**  
(OE 5001834576)

### SMD98

 p. 197

LED

 24V



**198650**  
(OE 504217797)



JPT-2P-M



**D13876**

JPT-2P-F

URBAN WAY

ICDL94

i | p. 187



**119550**  
(OE 5001020257)

JPT-3P-M



**001616**  
(OE 5001834568)



**D13877** JPT-3P-F



**001626**  
(OE 5001837993)

SMD98

i | p. 197

LED

⚡ 24V



**198650**  
(OE 504217797)

K

JPT-2P-M



**D13876** JPT-2P-F

R312 - R332

LC6

i | p. 170



**166500** K



**066500** K



# IVECO BUS

R312 - R332

## LC7

 p. 166



**167150**  
(OE 5010179915)



**067000**

## FE81

 p. 212



**181000**  
(OE 5000461058)



**181050**  
(OE 5000461059)

## AGORA - CITELIS

## LC7

p. 166



**167150**  
(OE 5010179915)



**067000**

## ICDL94

 p. 187



**119550**  
(OE 5001020257)

JPT-3P-M



**001616**  
(OE 5001834568)



**D13877**

JPT-3P-F



**001626**  
(OE 5001837993)

## AGORA - CITELIS

### SMD98

 p.197

LED

 24V



**198650**  
(OE 504217797)



JPT-2P-M



**D13876**

JPT-2P-F

### FPL93

 p.200



**193020**  
(OE 5010306792)



JPT-2P-M



**001726**  
(OE 5001847589)



**D13876**

JPT-2P-F

### FE85

 p.194



**185020**  
(OE 5010217022)



**185050**  
(OE 5010104837)

### FE95

 p.193



**195030**  
(OE 5001834505)



**195060**  
(OE 5001834576)

### 2751

 p.181



**D14517** C5W

### FPL93

 p. 200



**193020**  
(OE 5010306792)

**K**

**JPT-2P-M**



**001726**  
(OE 5001847589)



**D13876** **JPT-2P-F**

### FE81

 p. 212



**181000**  
(OE 5000461058)



**181050**  
(OE 5000461059)

### BD95



**195000**  
(OE 5010286898)



**001606**  
(OE 5001834564)

### FE95

 p. 193



**195030**  
(OE 5001834505)



**195060**  
(OE 5001834576)

## ARES / ILIADE

### ICDL94

 p. 187



**119550**  
(OE 5001020257)

JPT-3P-M



**001616**  
(OE 5001834568)



**D13877**

JPT-3P-F



**001626**  
(OE 5001837993)

### FPL93

 p. 200



**193020**  
(OE 5010306792)

**K**

JPT-2P-M



**001726**  
(OE 5001847589)



**D13876**

JPT-2P-F

## FR1

### FM91



**191170** - P21W  
(OE 5010197259)

Feu de recul  
Reverse lamp  
Rückfahrleuchte



**191140** - P21W  
(OE 5010197261)

Feu de position  
Position lamp  
Schlussleuchte



**191120** - P21W  
(OE 5010197262)

Feu stop  
Stop lamp  
Bremsleuchte



**191150** - P21W  
(OE 50101972564)

Feu clignotant arrière  
Reverse flasher lamp  
Hintere Blinkleuchte



**191110** - P21W  
(OE 5010197260)

Feu de brouillard  
Fog lamp  
Nebelschlussleuchte

## PEGASUS p.254

LED

 10/30V



**D14725**  
(OE W20TS01684)



## GALAXY p.260

LED

 10/30V



**D14749**  
(OE W20TS01401)



**D14513**  
(OE W20TS00777)

## LC12T LED

 p. 138

LED

 24V



**161000**

gauche - left - links



AMP 1.5-7P-M  
arrière  
rear connector  
Anschlusstecker hinten



**161010**

droit - right - rechts



**D11868** AMP 1.5-7P-F



**D11689** AMP 1.5-7P

## LC12 LED

 p. 138

LED

 24V



**161260**

gauche - left - links



AMP 1.5-7P-M  
arrière  
rear connector  
Anschlusstecker hinten



**161270**

droit - right - rechts



**D11868** AMP 1.5-7P-F



**D11689** AMP 1.5-7P

## LC8T

 p. 157



**156040**

gauche - left - links



AMP 1.5-7P-M  
arrière  
rear connector  
Anschlusstecker hinten



**156050**

droit - right - rechts



**D11868** AMP 1.5-7P-F



**056700**

gauche - left - links



**056710**

droit - right - rechts



**D11689** AMP 1.5-7P

# LAMBERET

## LC8

 p.154



**156310**

gauche - left - links



**AMP 1.5-7P-M**

arrière  
rear connector  
Anschlusstecker hinten



**156300**

droit - right - rechts



**D11868**

**AMP 1.5-7P-F**



**056500**

gauche - left - links



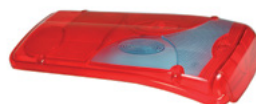

**056510**

droit - right - rechts





**D11689**

**AMP 1.5-7P**

## LC5T

 p.164



**153000**

gauche - left - links





**AMP 1.5-7P-M**

arrière  
rear connector  
Anschlusstecker hinten



**153010**

droit - right - rechts





**D11868**

**AMP 1.5-7P-F**

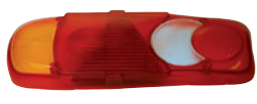

**053700**

gauche - left - links





**053710**

droit - right - rechts



## LPL18

 p.179

**LED**



12/24V

**NEW**



**199040**

**SS-2P-M**



**D13880**

**SS-2P-F**

## EPP96 LED

 p. 180

LED

 24V



**D13874** 2000 mm  
POS-2P-F

## EPP96

 p. 181



**196020**



**D10227** 700 mm  
POS-2P-F

## FE04

 p. 202

LED

 24V



**104330** 500 mm

## SMD04

 p. 196



LED

 24V



**104130** 500 mm   
CLICK-IN



**104090** 500 mm   
**104100** 1500 mm   
CLICK-IN



**104170** 500 mm   
CLICK-IN



**D14214**  
POS-2P-M



# LAMBERET

## SMD98 p.197

**LED**

 24V



**D10496** 1500 mm 

**CLICK-IN**



**001716**

## FA3 LED p.207

**LED**

 12/24V



**D13875** 1000 mm

## SL 1000 p.219

**LED**

 12/24V

 R23

**NEW**



**D14880**

## RCL 1200 p.250

**LED**

 9/30V

 1200 Lumen

**NEW**



**300010**

**NEW**



**300000**

chromé - chrome-plated - verchromt

## MDJ p.306



**175020**

## BL15-CTL15

 p. 145

**LED**

 24V



Exemple de montage - Assembly suggestion - Montagebeispiel

**NEW**



**164050**  
(OE 661058)

**NEW**



**164010**

Pour raccordement sur feu BL15  
To plug in BL15 lamp  
Zum direkten Anschluss an die leuchte BL15

**NEW**



**165020**  
gauche - left - links

**NEW**



**165030**  
droit - right - rechts



## FCA

 p. 307



**D11689**   **AMP 1.5-7P**

## LC8T p. 157



**156250**

gauche - left - links



**AMP 1.5-7P-M**

arrière  
rear connector  
Anschlusstecker hinten



**156260**

droit - right - rechts



**156380**

gauche - left - links



**156390**

droit - right - rechts



**D11868**

**AMP 1.5-7P-F**



**056720**

gauche - left - links



**056730**

droit - right - rechts



## LC5T p. 164



**153000**

gauche - left - links



**AMP 1.5-7P-M**

arrière  
rear connector  
Anschlusstecker hinten



**153010**

droit - right - rechts



**153130**

droit - right - rechts



**D11868**

**AMP 1.5-7P-F**

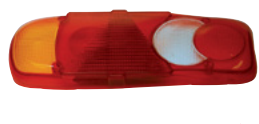

**053700**

gauche - left - links



**053710**

droit - right - rechts



## LC12T LED

 p. 138

LED

 24V



**161000**   
gauche - left - links



**AMP 1.5-7P-M**  
arrière  
rear connector  
Anschlusstecker hinten



**161010**   
droit - right - rechts



**D11868** **AMP 1.5-7P-F**



**D11689** **AMP 1.5-7P**

## SMD04

 p. 196

LED

 24V



**104140** 1500 mm   
**CLICK-IN**



**104100** 1500 mm   
**CLICK-IN**



**104250** 500 mm   
**CLICK-IN**

## FPL93

 p. 193



**193200**   
**JPT-2P-M**



**001726**



**D13876** **JPT-2P-F**

## SMD98

 p. 197

LED

 24V



**D10494** 500 mm 



**001786** 500 mm 

# LINDE

## SL 1000

 p. 222

**LED**

 12/24V

 1000 Lumen



**D14970**

**DT-2P-M**



**D14170**

**DT-2P-F**

## QL LED

 p. 239

**LED**

 12/24V-100V



**D14769**



**D14770**



**D14771**



**DT-2P-M**



**D14170**

**DT-2P-F**

## FRESNEL

 p. 259

**LED**

 10/110V



**D14746**



## LC12 LED



p. 138

LED



24V



**161000**



gauche - left - links



AMP 1.5-7P-M

arrière  
rear connector  
Anschlussstecker hinten



**161010**



droit - right - rechts



**D11868**

AMP 1.5-7P-F



**D14781**

SS-2P-F

gauche - left - links



**D14782**

SS-2P-F

droit - right - rechts

## SL 1000



p. 219

LED



12/24V



**D14857**

DT-2P-M

Feu homologué recul - Homologated reverse lamp -  
Genehmigt Rückfahrleuchte



**D14170**

DT-2P-F

04/2017 ->  
12V



**155550**  
(OE 65.25225-6004 / 7CE 945 095)  
gauche - left - links



**AMP 1.5-7P-M**  
arrière  
rear connector  
Anschlusstecker hinten

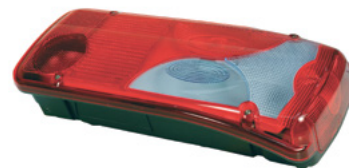

**155560**  
(OE 65.25225-6005 / 7CE 945 096)  
droit - right - rechts

## TGA - TGL - TGM - TGX

2005 ->



**156200**  
(OE 8125225-6544)  
gauche - left - links



**AMP 1.5-7P-M**  
latéral  
side connector  
Anschlusstecker seitlich

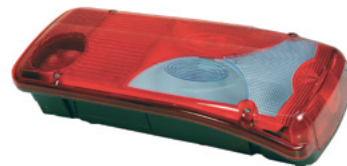

**156210**  
(OE 8125225-6545)  
droit - right - rechts

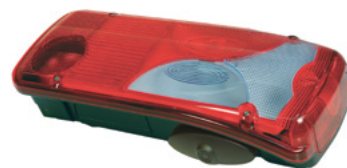

**156220**  
(OE 8125225-6547)  
droit - right - rechts



**D11868** **AMP 1.5-7P-F**



**056500**  
(OE 8125229-6059 /  
65.25229.0000 / 7CE  
945 111)



gauche - left - links



**056510**  
(OE 8125229-6060 /  
65.25229.001 / 7CE 945  
112)



droit - right - rechts



**001830** 90 Db

**001872** 55-90 Db



 LED

 10/110V

03/2018 ->



**212020**  
(OE 81.25207-6074)



**POS-2P-M**



**212030**  
(OE 81.25207-6075)



**POS-2P-M**



**D13879** **POS-2P-F**

L - M - F

LC7

 p. 166

1990 -> 2004



**168090**  
(OE 8125225-6033)    
gauche - left - links



**DIN 72480-8P-M**  
arrière  
rear connector  
Anschlusstecker hinten



**168090**  
(OE 8125225-6464)    
droit - right - rechts



**168100**  
(OE 8125225-6034)     
gauche - left - links



**168490**  
(OE 8125225-6528)     
droit - right - rechts



**067500**  
(OE 8125229-6051)   
gauche - left - links



**067500**  
(OE 8125229-6051)   
droit - right - rechts

TGA

LC7

 p. 166

1999 -> 2005



**169180**  
(OE 8125225-6526)    
gauche - left - links



**AMP 1.5-7P-M**  
latéral  
side connector  
Anschlusstecker seitlich



**169170**  
(OE 8125225-6523)    
droit - right - rechts



**169160**  
(OE 8125225-6524)     
gauche - left - links



**169190**  
(OE 8125225-6530)     
droit - right - rechts



**D11868** **AMP 1.5-7P-F**



**067500**  
(OE 8125229-6051)   
gauche - left - links



**067500**  
(OE 8125229-6051)   
droit - right - rechts





**166700**  
(OE 8125225-6469)



gauche - left - links



PE  
arrière  
rear connector  
Anschlussstecker hinten



**166700**  
(OE 8125225-6470)



droit - right - rechts



**066500**



gauche - left - links



**066500**



droit - right - rechts

## MANISCOPIC

### LC5

 p. 161

2001 ->



**152180**  
(OE 661973 / 223767)

gauche - left - links





**AMP 1.5-7P-M**

arrière  
rear connector  
Anschlusstecker hinten



**152180**  
(OE 661973 / 223766)

droit - right - rechts





**D11868** **AMP 1.5-7P-F**



**052500**  
(OE 661973)

gauche - left - links





**052500**  
(OE 661973)

droit - right - rechts



## MSI

### BBS516

 p. 175

1999 ->



**500930**  
(OE 163782)

gauche - left - links



PF  
arrière  
rear connector  
Anschlusstecker hinten



**500940**  
(OE 163783)

droit - right - rechts

### 2751

 p. 181



**D14517**  
(OE 227330)

## CHL 1 LED

 p. 242

**LED**

 12/24V



**D14380**  
(OE 959694 / 52562043)

gauche - left - links



**DT-6P-M**  
arrière  
rear connector  
Anschlusstecker hinten



**D14381**  
(OE 959695 / 52562044)

droit - right - rechts



**D14352** **DT-6P-F**

**LED**

**NEW**



9/32V



**212520**





## GROVE

### LC8

 p. 152



**156860**  
(OE 03137250)   

gauche - left - links



**AMP 1.5-7P-M**

arrière  
rear connector  
Anschlusstecker hinten



**156870**  
(OE 03137251)  

droit - right - rechts



**D11868** **AMP 1.5-7P-F**



**056540** 

gauche - left - links



**056550** 

droit - right - rechts





**001830**  
(OE 03137254) 

### LC5

 p. 161



**152170**  
(OE 03320939)  

gauche - left - links



**AMP 1.5-7P-M**

arrière  
rear connector  
Anschlusstecker hinten



**152180**  
(OE 03320938) 

droit - right - rechts



**D11868** **AMP 1.5-7P-F**



**052500** 

gauche - left - links



**052500** 

droit - right - rechts

### SMD98

 p. 197

**LED**

 24V



**198660**  
(OE 03138527) 

**JPT-2P-M**



**198520**  
(OE 03320937) 

**JPT-2P-M**



**D10493**  
(OE 03329572) 500 mm 

**CLICK-IN**



**198640**  
(OE 03329492) 

**JPT-2P-M**



**D13876** **JPT-2P-F**

vignal-group.com



08/2020 ->

**NEW**

**LED**

 24V



**212710**  
(OE A 960 820 02 58 / A 960 820 03 58)  



**MQS-2P-M**

## ZETROS

09/2019 ->

**NEW**



**155590**  
(OE A 959 544 01 03)     
gauche - left - links





**AMP 1.5-7P-M**

arrière  
rear connector  
Anschlusstecker hinten

**NEW**



**155600**  
(OE A 959 544 02 03)    
droit - right - rechts

**NEW**



**155610**  
(OE A 959 544 03 03)     
droit - right - rechts



**D11868** **AMP 1.5-7P-F**



**056540**  
(OE A 000 826 20 56)   
gauche - left - links



**056550**  
(OE A 000826 21 56)   
droit - right - rechts



**001830**  
Alarme sonore de recul  
Back up alarm  
Rückfahrsignalhorn

## SPRINTER

### LC11



 p. 141

03/2018 ->

**LED**

 12V





**160400**  
(OE A 910 820 64 00)   

gauche - left - links



**AMP 1.5-7P-M**  
arrière  
rear connector  
Anschlussstecker hinten



**160410**  
(OE A 910 820 65 00)  

droit - right - rechts



**D11868** **AMP 1.5-7P-F**



**060000**  
(OE A 910 826 10 00) 

gauche - left - links



**060010**  
(OE A 910 826 11 00) 



droit - right - rechts

### LC8

 p. 156

06/2006 ->





**156340**  
(OE A 906 820 04 64)   

gauche - left - links



**AMP 1.5-7P-M**  
arrière  
rear connector  
Anschlussstecker hinten



**156350**  
(OE A 906 820 17 64)  

droit - right - rechts



**D11868** **AMP 1.5-7P-F**



**056540**  
(OE A 000 826 20 56) 

gauche - left - links



**056550**  
(OE A 000 826 21 56) 

droit - right - rechts

## ATLAS



 p. 252

03/2018 ->

**LED**



 9/32V



**212010**  
(OE A 910 906 29 00 / A 910 906 64 00)  

**KOSTAL-2P-M**



**212420**  
(OE A 910 906 69 00)  

### SMD98

 p. 197

04/2019->

 LED

 24V

**NEW**



**198760**  
(OE A 956 544 00 11)

 K

SS-2P-M



**D13880**

SS-2P-F

### FE08 H1

04/2019->

 LED

 24V

**NEW**



**116200**  
(OE A 956 820 00 59)

## SONDERFAHRZEUG

### EPP96

 p. 181

06/2012 -> Lowliner



**196170**  
(OE A 949 540 01 04) 500 mm

HDSCS-3P-M

## VEGA LED

 p. 256

LED

 10/30V



**D14508**  
(OE 116119)



**D14513**  
(OE 115856)

## VEGA

 p. 261

 H1 -12/24V



**D14479**  
(OE 115855)



**D14513**  
(OE 115856)



## LPL18

 p. 179

**LED**

**NEW**

 12/24V

08/2020 ->

**199000**  
(OE 47363002)

**SS-2P-M**



**D13880**

**SS-2P-F**

## SMD98

 p. 197

**LED**

 12V

08/2018->

**198810**  
(OE 5141966)

**K**

**SS-2P-M**



**D13880**

**SS-2P-F**

## RH3

 p. 236

 H3/70W  
12V

08/2018 ->

**D14654**  
(OE 51431987)

**DT-2P-M**



**D14170**

**DT-2P-F**

## FT

 p. 234

**LED**

 12/24V

07/2017 ->

**D14191**  
(OE 47826594)



**D14192**

## NT400 - CABSTAR - ATLEON

### LC5

 p. 161



**152170**  
(OE 26555-9X126)

gauche - left - links



AMP 1.5-7P-M

arrière  
rear connector  
Anschlussstecker hinten



**152180**  
(OE 26555-9X125)

droit - right - rechts





**153120**  
(OE 26555-9X128)

droit - right - rechts



**D11868** AMP 1.5-7P-F



**052500**  
(OE 26554-9X126)

gauche - left - links





**052500**  
(OE 26554-9X126)

droit - right - rechts



## ICDL94

 p. 187



**119550**  
(OE 26164-9X402)

JPT-3P-M



**001616**  
(OE 26244-9X400)



**D13877** JPT-3P-F

# OMEPS

## LC12 LED p. 138

LED

 24V



**161280**

gauche - left - links



AMP 1.5-7P-M

arrière  
rear connector  
Anschlussstecker hinten



**161290**

droit - right - rechts



**D11868**

AMP 1.5-7P-F



**D14781**

gauche - left - links



**D14782**

droit - right - rechts



SS-2P-F

## EPP96 LED p. 180

LED

 12/24V



**R14364**

SS-2P-M

## SMD04 p. 196

LED

 12/24V

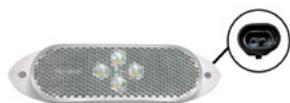

**104690**

**K**

SS-2P-M



**104670**

**K**

SS-2P-M



**D13880**

SS-2P-F

## CARBONLUX

 p. 220

LED

**NEW**

 10/30V

 R23



**D14811**

DT-2P-M



Interrupteur - switch - Schalter



**D14170**

DT-2P-F

## 5054

 p. 292



Max 6 kg

**D14538**

### LC5

 p. 161

04/2010 ->



**152180**  
(OE 4421265)

gauche - left - links





**AMP 1.5-7P-M**

arrière  
rear connector  
Anschlusstecker hinten



**152180**  
(OE 4421266)

droit - right - rechts





**D11868** **AMP 1.5-7P-F**



**052500**

gauche - left - links





**052500**

droit - right - rechts



### EPP98

 p. 181

04/2010 ->



**196010**  
(OE 4421269)

**JPT-2P-M**



**D13876** **JPT-2P-F**

07/2012 ->



Fixation 4 vis M6 (190x60mm)  
 Fixing 4 screws M6 (190x60mm)  
 Befestigung 4 Schrauben M6  
 (190x60mm)



**153270**  
 (OE 6350FS / 9815127080)



gauche - left - links



**AMP 1.5-7P-M**

arrière  
 rear connector  
 Anschlussstecker hinten



**153280**  
 (OE 6351FS / 9815126980)



droit - right - rechts



**D11868** **AMP 1.5-7P-F**



**052500**



gauche - left - links



**052500**



droit - right - rechts

# RENAULT TRUCKS

EURO 6 - T / K / C

LC9 LED

 p. 142



EURO 6

LED

 24V

12/2017->



**158030**  
(OE 7425982261 / 7422800385 / 7484585208)   

gauche - left - links





**AMP 1.5-7P-M**  
latéral  
side connector  
Anschlussstecker seitlich



**158050**  
(OE 7425982262 / 7423080010 / 7484585206)  

droit - right - rechts



**158040**  
(OE 7425982262 / 7422800386 / 7484585204)   

droit - right - rechts



**D11868** **AMP 1.5-7P-F**



**058000**  
(OE 7422800391) 

gauche - left - links



**058000**  
(OE 7422800391) 

droit - right - rechts

ATLAS

 p. 252

LED

 9/32V

09/2021->

**NEW**



**212740**  
(OE 23811106)  **AMP-4P-F**

**NEW**



**212750**  
(OE 23811107)  **AMP-4P-F**

TRI

 p. 217



**D10596**  
(OE 7423374865)

## EURO 6 - T / K / C --> 520 CH

LC9 ⓘ p. 160

### EURO 6

11/2013 ->



**159010**  
(OE 7420802348) K FPL EPP  
gauche - left - links



**AMP 1.5-7P-M**  
latéral  
side connector  
Anschlusstecker seitlich



**159020**  
(OE 7420802350) K FPL  
droit - right - rechts



**159030**  
(OE 7420802353) K FPL Speaker  
droit - right - rechts



**D11868** **AMP 1.5-7P-F**



**059000**  
(OE 7420802418) K  
gauche - left - links



**059000**  
(OE 7420802418) K  
droit - right - rechts



**D12953** Speaker

## LC10 LED ⓘ p. 143

### EURO 6

LED

24V

09/2020->



Entraxe : 152 mm  
Bolt distance : 152 mm  
Schraubenabstand : 152 mm

**NEW**



**159500**  
(OE 7423530440) K FPL EPP  
gauche - left - links



**AMP 1.5-7P-M**  
latéral  
side connector  
Anschlusstecker seitlich

**NEW**



**159530**  
(OE 7423530442) K FPL  
droit - right - rechts

**NEW**



**159520**  
(OE 7423530438) K FPL  
gauche - left - links

**NEW**



**159510**  
(OE 7423530441) K Speaker  
droit - right - rechts



**D11868** **AMP 1.5-7P-F**



**059500**  
(OE 7423292490) K  
gauche - left - links



**059500**  
(OE 7423292490) K  
droit - right - rechts



# RENAULT TRUCKS

EURO 6 - T / K / C --> 520 CH

## FE09

EURO6

11/2013 ->



**115020**  
(OE 7482346591)  
gauche - left - links



**115020**  
(OE 7482346591)  
droit - right - rechts



**115000**  
(OE 7482252506)  
gauche - left - links



**115010**  
(OE 7482367030)  
droit - right - rechts



**115040**  
(OE 7482252291)



**115030**  
(OE 7482255014)

## SL08

EURO6

11/2013 ->



**113020**  
(OE 7482266219) 10W  
Lampe de portière  
Door lamp  
Türleuchte



**113030**  
(OE 7482285707) 5W  
Feu d'embarquement  
Step lamp  
Einstiegsbeleuchtung

## SMD00

 p. 198

EURO6

LED

 24V

12/2013->



**198620**  
(OE 7482392733)   
Cuve blanche - cabochon PMMA  
White body - PMMA lens  
Weißes Gehäuse - PMMA Lichtscheibe



**198740**  
(OE 7482586940)   
Cuve ambre - cabochon PC haute température  
Amber body - PC lens high temperature  
Oranges Gehäuse - PC Lichtscheibe hoch temperatur beständig

## EURO 6 - T / K / C --> 520 CH

### SHD 1200

 p. 227

EURO 6

LED

 9/36V

07/2014 ->



**D14161**  
(OE 7484185589)

DT-2P-M



**D14170**

DT-2P-F

### SH3

 p. 237

EURO 6

11/2013 ->



- \* Lampe fournie
- \* Bulb included
- \* Inklusiv Glühlampen



**D13019 \***  
(OE 7421396991)

DT-2P-M



**D14170**

DT-2P-F

## MAGNUM

### LC9

 p. 160

01/2006 ->



**159010**  
(OE 7420802348)

gauche - left - links



AMP 1.5-7P-M

latéral  
side connector  
Anschlusstecker seitlich



**159020**  
(OE 7420802350)

droit - right - rechts



**159030**  
(OE 7420802353)

droit - right - rechts



**D11868** AMP 1.5-7P-F



**059000**  
(OE 7420802418)



gauche - left - links



**059000**  
(OE 7420802418)



droit - right - rechts



**D12953**



09/2004 -> 01/2006



**169310**  
(OE 5001864535)

gauche - left - links



**AMP 1.5-7P-M**

latéral  
side connector  
Anschlussstecker seitlich

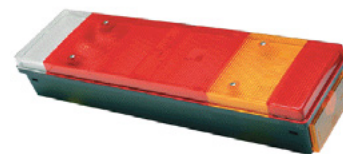

**169320**  
(OE 5001864536)

droit - right - rechts



Entraxe : 160 mm  
Bolt distance : 160 mm  
Schraubenabstand : 160 mm

12/1998 -> 09/2004



**169020**  
(OE 5001847586)

gauche - left - links



**AMP 1.5-7P-M**

latéral  
side connector  
Anschlussstecker seitlich



**169030**  
(OE 5001847587)

droit - right - rechts



**169000**  
(OE 5001847584)

gauche - left - links

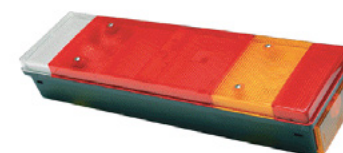

**169010**  
(OE 5001847585)

droit - right - rechts



**D11868**

**AMP 1.5-7P-F**



**067000**  
(OE 5000296594)

**067500**  
(OE 5001847588)

gauche - left - links



**067000**  
(OE 5000296594)

**067500**  
(OE 5001847588)

droit - right - rechts



**D12953**



## MAGNUM

### LC7

 p. 166

1990 -> 1994



**167100**  
(OE 5000296592)

gauche - left - links





PE  
arrière  
rear connector  
Anschlussstecker hinten



**167000**  
(OE 5000296592)

droit - right - rechts

1994 -> 12/1998



**168220**  
(OE 5001831194)

gauche - left - links

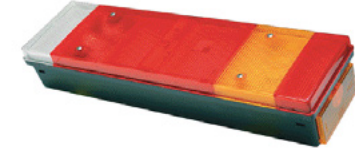

**168260**  
(OE 5001832999)

droit - right - rechts



**067000**  
(OE 5000296594)

**067500**  
(OE 5001847588)

gauche - left - links





**067000**  
(OE 5000296594)

**067500**  
(OE 5001847588)

droit - right - rechts



### LC6

 p. 170

1991 -> 12/1998



**166100 \***  
(OE 5000296591)

gauche - left - links





PE  
arrière  
rear connector  
Anschlussstecker hinten



**166000 \***  
(OE 5000296591)

droit - right - rechts

12/1998 -> 09/2004



**169060**  
(OE 5001847582)

gauche - left - links





AMP 1.5-7P-M  
latéral  
side connector  
Anschlussstecker seitlich



**169070**  
(5001847583)

droit - right - rechts



**D11868** AMP 1.5-7P-F



**066000**  
(OE 5000296593)

gauche - left - links



**066000**  
(OE 5000296593)

droit - right - rechts

# RENAULT TRUCKS

## MAGNUM

### FE85

 p. 194

1991 ->



**185020**  
(OE 5010217022)  
gauche - left - links



**185020**  
(OE 5010217022)  
droit - right - rechts

1991 -> 12/1998



**185040**  
(OE 5010217023) 5W  
gauche - left - links



**185040**  
(OE 5010217023) 5W  
droit - right - rechts

12/1998 ->



**185160**  
(OE 5010271807) 21W  
gauche - left - links



**185160**  
(OE 5010271807) 21W  
droit - right - rechts

### FE04

 p. 190

**LED**

 24V

06/2008 ->



**104570**  
(OE 7421430181/7482562006)

**DT-2P-M**



**104450**  
(OE 7421137718)

**DT-2P-M**



**D14170**

**DT-2P-F**

### FPL93

 p. 200

1994 ->



**193020**  
(OE 5010306792 / 7484538758)

**JPT-2P-M**



**001726**  
(OE 5001847589)



**D13876**

**JPT-2P-F**

## MAGNUM

### FE02

 p. 193

2003 ->



**102200**  
(OE 5001862030)   
Clippé - clipped - clip-befestigung  
**JPT-2P-M**



**001726**  
(OE 5001847589)



**D13876** **JPT-2P-F**

## SH3

 p. 237

10/2009 ->



- \* Lampe fournie
- \* Bulb included
- \* Inklusiv Glühlampen



**D13019** \*  
(OE 7421396991)  
**DT-2P-M**



**D14170** **DT-2P-F**

## PREMIUM / KERAX / EURO 6 - C --> 320 CH

### LC9

 p. 160

## EURO 6

01/2006 ->



**159010**  
(OE 7420802348)     
gauche - left - links



**AMP 1.5-7P-M**  
latéral  
side connector  
Anschlusstecker seitlich



**159020**  
(OE 7420802350)    
droit - right - rechts



**159030**  
(OE 7420802353)     
droit - right - rechts



**D11868** **AMP 1.5-7P-F**



**059000**  
(OE 7420802418)   
gauche - left - links



**059000**  
(OE 7420802418)   
droit - right - rechts



**D12953** 

Premium  
09/2004 -> 01/2006  
Kerax  
09/2004 -> 09/2006



Entraxe : 160 mm  
Bolt distance : 160 mm  
Schraubenabstand : 160 mm



**169310**  
(OE 5001864535)



gauche - left - links



AMP 1.5-7P-M

latéral  
side connector  
Anschlussstecker seitlich

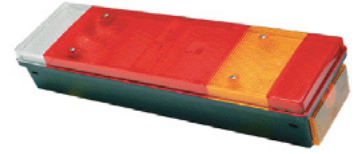

**169320**  
(OE 5001864536)



droit - right - rechts



**D11868**

AMP 1.5-7P-F



**067500**  
(OE 5001847588)



gauche - left - links



**067500**  
(OE 5001847588)



droit - right - rechts

Premium  
1999 -> 09/2004



**169020**  
(OE 5001847586)



gauche - left - links



AMP 1.5-7P-M

latéral  
side connector  
Anschlussstecker seitlich



**169030**  
(OE 5001847587)



droit - right - rechts

Premium  
1999 -> 09/2004  
Kerax  
09/1998 -> 09/2004



**169000**  
(OE 5001847584)



gauche - left - links

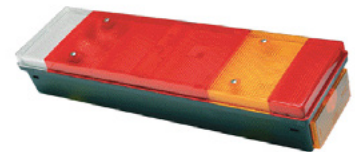

**169010**  
(OE 5001847585)



droit - right - rechts



**D11868**

AMP 1.5-7P-F



**067000**  
(OE 5000296594)

**067500**  
(OE 5001847588)



gauche - left - links



**067000**  
(OE 5000296594)

**067500**  
(OE 5001847588)



droit - right - rechts



**D12953**





## PREMIUM / KERAX

### LC7

 p. 166

Premium  
1995 -> 1999  
Kerax  
1995 -> 09/1998





**168220**  
(OE 5001831194)  

 **168260**  
(OE 5001832999)   
gauche - left - links

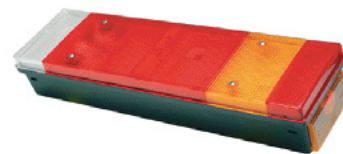

PE  
arrière  
rear connector  
Anschlusstecker hinten



**168260**  
(OE 5001832999) 

 **168140**  
(OE 5001835853)    
droit - right - rechts



**067000**  
(OE 5000296594)  
gauche - left - links



**067000**  
(OE 5000296594)  
droit - right - rechts

## LC5

Premium  
06/2001 -> 09/2004



**152020 \***  
(OE 5001846847) 

 **152510 \*\***  
(OE 5001857964)   
gauche - left - links



AMP 1.5-7P-M  
arrière  
rear connector  
Anschlusstecker hinten



**152500 \*\***  
(OE 5001858092)

 **152520 \***  
(OE 5001857965)  
droit - right - rechts

\* pas de fonction recul  
\* no reverse function  
\* ohne Rückfahrchein werfer  
\*\* pas de fonction brouillard  
\*\* no fog function  
\*\* ohne Nebelschlussleuchte



**D11868** AMP 1.5-7P-F



**052000**  
(OE 5010392231)  
gauche - left - links



**052000**  
(OE 5010392231)  
droit - right - rechts



# RENAULT TRUCKS

## PREMIUM / KERAX

### LC6

 p. 170

Premium  
12/1998 -> 09/2004



**169060**  
(OE 5001847582)

gauche - left - links



AMP 1.5-7P-M

latéral  
side connector  
Anschlussstecker seitlich



**169070**  
(OE 5001847583)

droit - right - rechts

\* Silent blocs non fournis,  
voir réf. 001706 p. 170

\*Silent blocs not supplied,  
see p/n 001706 p. 170

\* Schwingungsdämpfer Art.-Nr.  
001706 nicht im Lieferumfang, s.  
Seite p. 170

Premium  
1995 -> 12/1998



Kerax  
1995 -> 09/1998



**166100 \***  
(OE 5000296591)

gauche - left - links



PE  
arrière  
rear connector  
Anschlussstecker hinten



**166000 \***  
(OE 5000296591)

droit - right - rechts



**D11868** AMP 1.5-7P-F



**066000**  
(OE 5000296593)

gauche - left - links



**066000**  
(OE 5000296593)

droit - right - rechts

## PREMIUM / KERAX / EURO 6 - C --> 320 CH

### FE95

 p. 193

### EURO6

1995 ->



**195010**  
(OE 5001834561)

gauche - left - links



**195010**  
(OE 5001834561)

droit - right - rechts

PREMIUM / KERAX / EURO 6 - C --> 320 CH

## ICDL94



p. 187

### EURO 6

1995 ->

Premium 12/1998 ->  
Kerax 1999 ->



**119450**  
(OE 5001834565)

5W

JPT-3P-M



**119470**  
(OE 5001847597)

21W

JPT-3P-M



**001616**  
(OE 5001834568)



**D13877**

JPT-3P-F

## FE02



p. 193

### EURO 6

2003 ->



**102200**  
(OE 5001862030)

K

Clippé - clipped - clip-befestigung

JPT-2P-M



**001726**  
(OE 5001847589)



**D13876**

JPT-2P-F

## SMD98



p. 197

### EURO 6

LED

24V

09/2007 ->



**198650**  
(OE 7421106206)

K

Feu d'identification Viscope  
Viscope identification lamp  
Markierungsleuchte Viscope

JPT-2P-M



**D13876**

JPT-2P-F

# RENAULT TRUCKS

PREMIUM / KERAX / EURO 6 - C --> 320 CH

## FPL93

 p. 193

2003 ->



**193200**  
(OE 5001862030)

Vissé - Screwed - Geschraubt

**JPT-2P-M**

1995 ->



**193020**  
(OE 5010306792)

**JPT-2P-M**



**001726**  
(OE 5001847589)



**D13876** **JPT-2P-F**

## SH3

 p. 237



24V

10/2009 ->



- \* Lampe fournie
- \* Bulb included
- \* Inklusiv Glühlampen



**D13019 \***  
(OE 7421396991)

**DT-2P-M**



**D14170** **DT-2P-F**

## MIDLINER

### LC4

 p. 171



**141500**  
(OE 5000808172)

gauche - left - links

**K EPP**



PE  
arrière  
rear connector  
Anschlussstecker hinten



**141500**  
(OE 5000808172)

droit - right - rechts

**K EPP**



**040500**  
(OE 5000808166)

gauche - left - links

**K**



**040500**  
(OE 5000808166)

droit - right - rechts

**K**

## EURO 6 - D --> 18 T

### LC10 LED p. 143

EURO6

LED

 24V

09/2020->

 Entraxe : 152 mm  
Bolt distance : 152 mm  
Schraubenabstand : 152 mm



**NEW**



**159500**  
(OE 7423530440)     
gauche - left - links



**AMP 1.5-7P-M**  
latéral  
side connector  
Anschlusstecker seitlich

**NEW**



**159530**  
(OE 7423530442)    
droit - right - rechts

**NEW**



**159520**  
(OE 7423530438)    
gauche - left - links

**NEW**



**159510**  
(OE 7423530441)     
droit - right - rechts



**D11868** **AMP 1.5-7P-F**



**059500**  
(OE 7423292490)   
gauche - left - links



**059500**  
(OE 7423292490)   
droit - right - rechts

## LC5

 p. 161

EURO6

09/2021->

**NEW**



**152170**  
(OE 5010595381)    
gauche - left - links



**AMP 1.5-7P-M**  
arrière  
rear connector  
Anschlusstecker hinten

**NEW**



**152180**  
(OE 5010595382)   
droit - right - rechts



**D11868** **AMP 1.5-7P-F**



**052500**  
(OE 5001847153)   
gauche - left - links



**052500**  
(OE 5001847153)   
droit - right - rechts

# RENAULT TRUCKS

MIDLUM / EURO 6 - D --> 18 T

LC7

 p. 166

1999 -> 04/2006



**169000**  
(OE 5001847584)     
gauche - left - links



**AMP 1.5-7P-M**  
latéral  
side connector  
Anschlussstecker seitlich

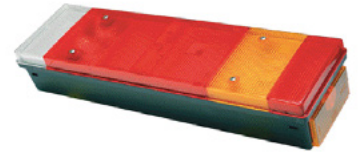

**169010**  
(OE 5001847585)    
droit - right - rechts



**D11868** **AMP 1.5-7P-F**



**067500**  
(OE 5001847588)   
gauche - left - links



**067500**  
(OE 5001847588)   
droit - right - rechts

LC5

 p. 163

EURO6

09/2005 ->



**152880**  
(OE 7420862032)   
gauche - left - links



**AMP 1.5-7P-M**  
arrière  
rear connector  
Anschlussstecker hinten



**152880**  
(OE 7420862035)   
droit - right - rechts

1999 -> 09/2005



\* pas de fonction recul  
\* no reverse function  
\* ohne Rückfahrchein werfer

\*\* pas de fonction brouillard  
\*\* no fog function  
\*\* ohne Nebelschlussleuchte



**152000 \***  
(OE 5001846843) 



**152040 \*\***  
(OE 5001846845)   
gauche - left - links



**152010 \*\***  
(OE 5001846844) 



**152050 \***  
(OE 5001846846)   
droit - right - rechts



**D11868** **AMP 1.5-7P-F**



**052500**  
(OE 5001847153)   
gauche - left - links



**052500**  
(OE 5001847153)   
droit - right - rechts

## MIDLUM / EURO 6 - D --> 18 T

### LC5

 p. 161

### EURO 6

09/2005 ->



**152190**  
(OE 7420862038)

gauche - left - links





**AMP 1.5-7P-M**  
arrière  
rear connector  
Anschlussstecker hinten



**152200**  
(OE 7420862041)

droit - right - rechts

1999 -> 09/2005



\* pas de fonction recul  
\* no reverse function  
\* ohne Rückfahrchein werfer

\*\* pas de fonction brouillard  
\*\* no fog function  
\*\* ohne Nebelschlussleuchte



**152020 \***  
(OE 5001846847)



**152060 \*\***  
(OE 5001846849)

gauche - left - links







**152030 \*\***  
(OE 5001846848)



**152070 \***  
(OE 5001846850)

droit - right - rechts



**D11868** **AMP 1.5-7P-F**



**052000**  
(OE 5010392231)  
gauche - left - links



**052000**  
(OE 5010392231)  
droit - right - rechts

### EPP96

 p. 181

1999 -> 2003



**196020**  
(OE 7700353021)

### EPP98

 p. 181

### EURO 6

2003 ->



**196010**  
(OE 5010293829)

**JPT-2P-M**



**D13876** **JPT-2P-F**

# RENAULT TRUCKS

MIDLUM / EURO 6 - D --> 18 T

## FM91

08/2008 ->



**191170**  
(OE 7421268609)

## ICDL94



p. 187

## EURO 6

-> 1999

1999 ->



**119450**  
(OE 5001834565)

5W

JPT-3P-M



**119470**  
(OE 5001847597)

21W

JPT-3P-M



**001616**  
(OE 5001834568)



**D13877**

JPT-3P-F

## FE95



p. 193

## EURO 6

1999 ->



**195010**  
(OE 5001834561)

gauche - left - links



**195010**  
(OE 5001834561)

droit - right - rechts

## FE02



p. 193

## EURO 6

2003 ->



**102200**  
(OE 5001862030)

Clippé - clipped - clip-befestigung

K



**001726**  
(OE 5001847589)



**D13876**

JPT-2P-F

JPT-2P-M

## MIDLUM / EURO 6 - D --> 18 T

### FPL93

 p. 200

1999 ->



**193020**  
(OE 5010306792)



JPT-2P-M



**193280**  
(OE 7420894265)



JPT-2P-M



**001726**  
(OE 5001847589)



**D13876** JPT-2P-F

## MAXITY / EURO 6 - D --> 7,5 T

### LC5

 p. 161

### EURO6

2009 ->



**152170**  
(OE 7485118470)  
gauche - left - links







AMP 1.5-7P-M

arrière  
rear connector  
Anschlussstecker hinten



**152180**  
(OE 5001870556)  
droit - right - rechts





**D11868** AMP 1.5-7P-F



**052500**  
(OE 5001847153)  
gauche - left - links





**052500**  
(OE 5001847153)  
droit - right - rechts





# RENAULT TRUCKS

## MASCOTT

### LC5

#### EURO 6

04/2006 ->

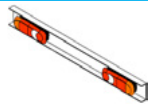

**152880**  
(OE 7420862032)

gauche - left - links



**AMP 1.5-7P-M**  
arrière  
rear connector  
Anschlusstecker hinten



**152880**  
(OE 7420862035)

droit - right - rechts



07/2001 -> 04/2006

\* pas de fonction recul  
\* no reverse function  
\* ohne Rückfahrchein werfer

\*\* pas de fonction brouillard  
\*\* no fog function  
\*\* ohne Nebelschlussleuchte



**152000 \***  
(OE 5001846843)

gauche - left - links



**152600 \*\***  
(OE 5001858093)

droit - right - rechts



**D11868** **AMP 1.5-7P-F**



**052500**  
(OE 5001847153)

gauche - left - links



**052500**  
(OE 5001847153)

droit - right - rechts



### LC5

 p. 161

04/2006 ->



**152170**  
gauche - left - links



**AMP 1.5-7P-M**  
arrière  
rear connector  
Anschlusstecker hinten



**152180**  
droit - right - rechts



**D11868** **AMP 1.5-7P-F**



**052500**  
(OE 5001847153)

gauche - left - links



**052500**  
(OE 5001847153)

droit - right - rechts



## MASCOTT

### LC5

07/2001 -> 04/2006

\* pas de fonction recul  
\* no reverse function  
\* ohne Ruckfahrtschein werfer

\*\* pas de fonction brouillard  
\*\* no fog function  
\*\* ohne Nebelschlussleuchte



**152020 \***  
(OE 5001846847) EPP

 **152510 \*\***  
(OE 5001857964) EPP

gauche - left - links



AMP 1.5-7P-M

arrière  
rear connector  
Anschlusstecker hinten



**152500 \*\***  
(OE 5001858092)

 **152520 \***  
(OE 5001857965)

droit - right - rechts



**D11868** AMP 1.5-7P-F



**052000**  
(OE 5010392231)  
gauche - left - links



**052000**  
(OE 5010392231)  
droit - right - rechts

### LC4

 p.171

1998 -> 07/2001



**141500**  
(OE 5000808172) K EPP  
gauche - left - links



PE  
arrière  
rear connector  
Anschlusstecker hinten



**141500**  
(OE 5000808172) K EPP  
droit - right - rechts



**040500**  
(OE 5000808166) K  
gauche - left - links



**040500**  
(OE 5000808166) K  
droit - right - rechts

### EPP98

 p.181

1998 ->



**196010**  
(OE 5010293829)

JPT-2P-M



**D13876** JPT-2P-F

# RENAULT TRUCKS

## MASCOTT

### ICDL94

 p. 187

1998 ->



**119450**  
(OE 5001834565) 5W  
**JPT-3P-M**



**001616**  
(OE 5001834568)



**D13877** **JPT-3P-F**

### SMD98

 p.197

**LED**



4xLEDS - 12V

1998 ->



**198510**  
(OE 7700377208) **K**  
**JPT-2P-M**



**D13876** **JPT-2P-F**

### CA

 p. 216

1998 -> 04/2006



**D14590**  
(OE 7700377130)

04/2006 ->

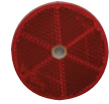

**D14593**  
(OE 8200602314)

## TRAFIC

### LC5

 p. 161

10/2014 ->



**152180** **K**  
(OE 265551402R)  
**152180** **K**  
(OE 265550674R)   
gauche - left - links



**AMP 1.5-7P-M**  
arrière  
rear connector  
Anschlusstecker hinten



**152180** **K**  
(OE 265504514R)  
**152180** **K**  
(OE 265500292R)   
droit - right - rechts



**D11868** **AMP 1.5-7P-F**



**052500** **K**  
(OE 5001847153)  
gauche - left - links



**052500** **K**  
(OE 5001847153)  
droit - right - rechts

## MASTER

### LC5

 p. 161

04/2010 ->



**152180**  
(OE 265551402R) 

**152180**  
(OE 265550674R)  

gauche - left - links



AMP 1.5-7P-M

arrière  
rear connector  
Anschlusstecker hinten



**152180**  
(OE 265504514R) 

 **152180**  
(OE 265500292R) 

droit - right - rechts



**D11868** AMP 1.5-7P-F



**052500**  
(OE 5001847153) 

gauche - left - links



**052500**  
(OE 5001847153) 

droit - right - rechts

## EPP96

 p. 181

-> 04/2010



**196020**  
(OE 7700353021)

## EPP98

 p. 181

-> 04/2010



**196010**  
(OE 265100848R)

JPT-2P-M



**D13876** JPT-2P-F

## SMD98

 p.197

LED

 4xLEDS - 12V

-> 04/2010



**198580** 

JPT-2P-M



**D13876** JPT-2P-F

# RENAULT TRUCKS

## GAMME B

### LC4

 p.171



**141000**  
(OE 5000808171)  
gauche - left - links





PE  
arrière  
rear connector  
Anschlussstecker hinten



**141000**  
(OE 5000808171)  
droit - right - rechts





**040000**  
(OE 5000807304)  
gauche - left - links



**040000**  
(OE 5000807304)  
droit - right - rechts

### FE85

 p.194



**185020**  
(OE 5010217022)  
gauche - left - links





**185020**  
(OE 5010217022)  
droit - right - rechts

### FPL93

 p.200



**193020**  
(OE 5010306792 / 7484538758)   



**001726**  
(OE 5001847589)



**D13876** 

## GAMME C

### LC4

 p.171

-> 1986



**141500**  
(OE 5000808172)  
gauche - left - links



PE  
arrière  
rear connector  
Anschlussstecker hinten



**141500**  
(OE 5000808172)  
droit - right - rechts



**040500**  
(OE 5000808166)  
gauche - left - links





**040500**  
(OE 5000808166)  
droit - right - rechts



### FE81

 p.212



**181050**  
(OE 5000461059)



**181000**  
(OE 5000461058)

### FE88

 p.211



**188310**  
(OE 5000623050)



**088010**  
(OE 5000296718)

# RENAULT TRUCKS

## GAMME G

### LC4

 p.171

-> 1986



**141000**  
(OE 5000808171)



**141500**  
(OE 5000808172)

gauche - left - links



PE  
arrière  
rear connector  
Anschlussstecker hinten



**141000**  
(OE 5000808171)



**141500**  
(OE 5000808172)

droit - right - rechts



**040000**  
(OE 5000807304)

**040500**  
(OE 5000808166)

gauche - left - links



**040000**  
(OE 5000807304)

**040500**  
(OE 5000808166)

droit - right - rechts

### LC6

 p.170

1986 ->



**166000**  
(OE 5000296591)

gauche - left - links



PE  
arrière  
rear connector  
Anschlussstecker hinten



**166000**  
(OE 5000296591)

droit - right - rechts



**066000**  
(OE 5000296593)

gauche - left - links



**066000**  
(OE 5000296593)

droit - right - rechts

## GAMME J

### FE81

 p. 212



**181050**  
(OE 5000461059)



**181000**  
(OE 5000461058)

### FE88

 p. 211



**188310**  
(OE 5000623050)



**088010**  
(OE 5000296718)

### FPL93

 p. 200



**193020**  
(OE 5010306792 / 7484538758) 

 JPT-2P-M



**001726**  
(OE 5001847589)



**D13876**  JPT-2P-F



# RENAULT TRUCKS

## GAMME R

### LC7

 p.166

1994 ->



**167100**  
(OE 5000296592)  
gauche - left - links





PE  
arrière  
rear connector  
Anschlussstecker hinten



**167000**  
(OE 5000296592)  
droit - right - rechts



**168220**  
(OE 5001831194)  
gauche - left - links

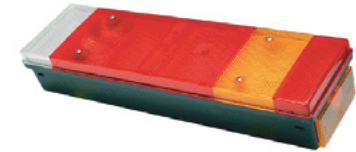

**168260**  
(OE 5001832999)  
droit - right - rechts



**067000**  
(OE 5000296594)

**067500**  
(OE 5001847588)  
gauche - left - links





**067000**  
(OE 5000296594)

**067500**  
(OE 5001847588)  
droit - right - rechts



### LC4

 p.171

-> 1994



**141000**  
(OE 5000808171)  
gauche - left - links





PE  
arrière  
rear connector  
Anschlussstecker hinten



**141000**  
(OE 5000808171)  
droit - right - rechts





**040000**  
(OE 5000807304)  
gauche - left - links





**040000**  
(OE 5000807304)  
droit - right - rechts

## GAMME R

### FPL93

 p. 200



**193020**  
(OE 5010306792 / 7484538758)   



**001726**  
(OE 5001847589)



**D13876** 

## GAMME S

### LC4

 p. 171



**141000**  
(OE 5000808171)   
gauche - left - links



PE  
arrière  
rear connector  
Anschlussstecker hinten



**141000**  
(OE 5000808171)   
droit - right - rechts



**040000**  
(OE 5000807304)  
gauche - left - links



**040000**  
(OE 5000807304)  
droit - right - rechts

### FE87

 p. 211



**188310**  
(OE 5000623050)



**088010**  
(OE 5000296718)

10/2020 ->

**NEW**

**LED**

 9/32V



**212420**



## SERIE P&R

### LC8

 p.155

08/2013 ->



**155080**  
(OE 2160128)

gauche - left - links



**AMP 1.5-7P-M**

arrière  
rear connector  
Anschlusstecker hinten



**155520**  
(OE 2340796)

droit - right - rechts



**155090**  
(OE 2160127)

droit - right - rechts

01/2007 ->



**156770**  
(OE 1756754/2021579/2129985)

gauche - left - links



**AMP 1.5-7P-M**

latéral  
side connector  
Anschlusstecker seitlich



**156780**  
(OE 1756751/2021575/2129987)

droit - right - rechts



**155020**  
(OE 2021578/2129986)

droit - right - rechts



**156790**  
(OE 1791369/2021576/2129988)

droit - right - rechts



**D11868** **AMP 1.5-7P-F**



**056540**  
(OE 1784669/2129992)  
gauche - left - links





**056550**  
(OE 1784670/2129991)  
droit - right - rechts





**001830**



### LC7

 p. 168

1990 -> 1998



**168350**  
(OE 1365963)     
gauche - left - links



**168360**  
(OE 1365964)    
droit - right - rechts



**067500**  
(OE 1350343)   
gauche - left - links



**067500**  
(OE 1350343)   
droit - right - rechts

### SLA 2000

 p. 223

 LED

**NEW**



12/24V



2000 Lumen



**D14852**  
(OE 2862201)  





**D14170** 

### SH3

 p. 237



- \* Lampe fournie
- \* Bulb included
- \* Inklusiv Glühlampen

**D13019 \***  
(OE 7421396991)  



**D14170** 

### TRI

 p. 217



**D10596**  
(OE 2020496)

## LC12 LED

 p. 138

**LED**

 24V

**GLOWING**



**NEW**



**161280**  
(OE 1370066)  
gauche - left - links



**AMP 1.5-7P-M**  
arrière  
rear connector  
Anschlusstecker hinten

**NEW**



**161290**  
(OE 1370067)  
droit - right - rechts



**D11868** **AMP 1.5-7P-F**

## LC12 LED

 p. 138

**LED**

 24V

**ORIGINAL**



**161000**  
(OE 1302341 / 1364736)  
gauche - left - links



**AMP 1.5-7P-M**  
arrière  
rear connector  
Anschlusstecker hinten



**161010**  
(OE 1302342 / 1364737)  
droit - right - rechts



**D11868** **AMP 1.5-7P-F**

## LCR19

 p. 146

**LED**

 24V

**SMC**

Position latéral clignotant  
Side marker flashing lamp  
Blinkende seiten markierungs-  
leuchte

**POS**

Position  
Schlußlicht

**RI**

Resistance intégrée (contrôle  
défaillance indicateur)  
Integrated resistance (indicator  
failure control)  
Integrierter widerstand (blin-  
kleuchtenausfallkontrolle)

**NEW**



**213010**  
(OE 1415545)

**AMP MCP-4P-M**

Position Glowing - Stop - Clignotant  
Glowing position - Stop - Indicator  
Glowing Schlußlicht - Bremslicht - Blinker

**NEW**





**213090**  
(OE 1415546)

**AMP MCP-4P-M**

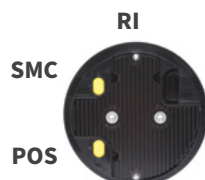
Position Glowing - Stop - Clignotant  
Glowing position - Stop - Indicator  
Glowing Schlußlicht - Bremslicht - Blinker



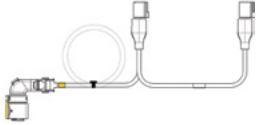
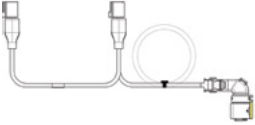
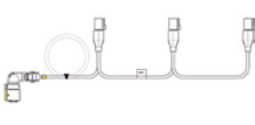

<b>AMP-MCP-4P-F</b> 	<b>AMP-MCP-4P-F</b> 	<b>AMP-MCP-4P-F</b> 	<b>AMP-MCP-4P-F</b> 
<b>D14846</b> (OE 1415543) <b>HDSCS-6P-F</b> gauche - left - links	<b>D14847</b> (OE 1415544) <b>HDSCS-6P-F</b> droit - right - rechts	<b>D14884</b> (OE 1437099) <b>HDSCS-6P-F</b> gauche - left - links	<b>D14885</b> (OE 1437100) <b>HDSCS-6P-F</b> droit - right - rechts



**LED**



10/30V



**D14488**  
(OE 1348566)



## LC12 LED p. 138

**LED**  
24V



**161000**   
gauche - left - links



**AMP 1.5-7P-M**  
arrière  
rear connector  
Anschlusstecker hinten



**161010**   
droit - right - rechts



**D11868** **AMP 1.5-7P-F**



**D14781** **SS-2P-F**  
gauche - left - links



**D14782** **SS-2P-F**  
droit - right - rechts

## LC8T p. 157



**156040**    
gauche - left - links



**AMP 1.5-7P-M**  
arrière  
rear connector  
Anschlusstecker hinten



**156050**    
droit - right - rechts



**056700**   
gauche - left - links



**056710**   
droit - right - rechts



**D12712** **POS-2P-F**  
gauche - left - links



**D12711** **POS-2P-F**  
droit - right - rechts



**D11868** **AMP 1.5-7P-F**

## EPP96 LED p. 180

**LED**  
24V



**R14364** 2000 mm  
**SS-2P-F**



# SOR IBERICA

## EPP96

 p. 181



**D11888**

1000 mm

**CLICK-IN**

## SMD04

 p. 196

**LED**

 24V



**104100**

1500 mm

**CLICK-IN**



**104650**

1000 mm

bride rallongée - extended bracket - Montagewinkel längerter

**CLICK-IN**

## SMCU

 p. 196

 12/24V



**D14722**

**SS-2P-M** **SS-3P-M**

## FA3LED

 p. 207

**LED**

 12/24V



**D14427**

1500 mm

gauche - left - links

**CLICK-IN**



**D14428**

1500 mm

droit - right - rechts

**CLICK-IN**



**D14425**

gauche - left - links

**SS-2P-F**



**D14426**

droit - right - rechts

**SS-2P-F**

## SH3

 p. 236

 H3/55W  
12V

09/2017 ->



**D14156**  
(OE 48159167)

**DT-2P-M**



**D14170**

**DT-2P-F**

## RH3

 p. 236

 H3/55W  
12V

01/2021 ->



**D14654**  
(OE 51431987)

**DT-2P-M**



**D14170**

**DT-2P-F**

# STILL

## CL 1 LED

 p. 244

LED

 12/24V



**D14649**

## RL 1000

 p. 225

LED

 12/24V

 1000 Lumen



**D14853**

DT-2P-M



**D14170**

DT-2P-F

## SHD BLUE

 p. 239

LED

 12/24V-100V



**D14249**

DT-2P-M



**D14170**

DT-2P-F

## FRESNEL

 p. 259

LED

 10/110V



**D14746**



## BL15

 p. 145

LED

 24V

**NEW**



DT04-4P-M



DTM06-4S-4P-F

**NEW**



**165040**

gauche - left - links

**165050**

droit - right - rechts



**D14436** DT06-4S-4P-F



**D14437** DTM06-4S-4P-F



**D14435** DTM04-4P-M

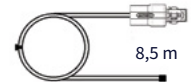

**R14338** DT06-4S-4P-F

## CTL15

 p. 144

LED

 24V

**NEW**



DT04-4P-M



DTM06-4S-4P-F

**NEW**



**164020**

gauche - left - links

**164030**

droit - right - rechts



**D14436** DT06-4S-4P-F



**D14437** DTM06-4S-4P-F



**D14435** DTM04-4P-M



**R14339** DT06-4S-4P-F

## CTL15-BL15

 p. 145

LED

 24V

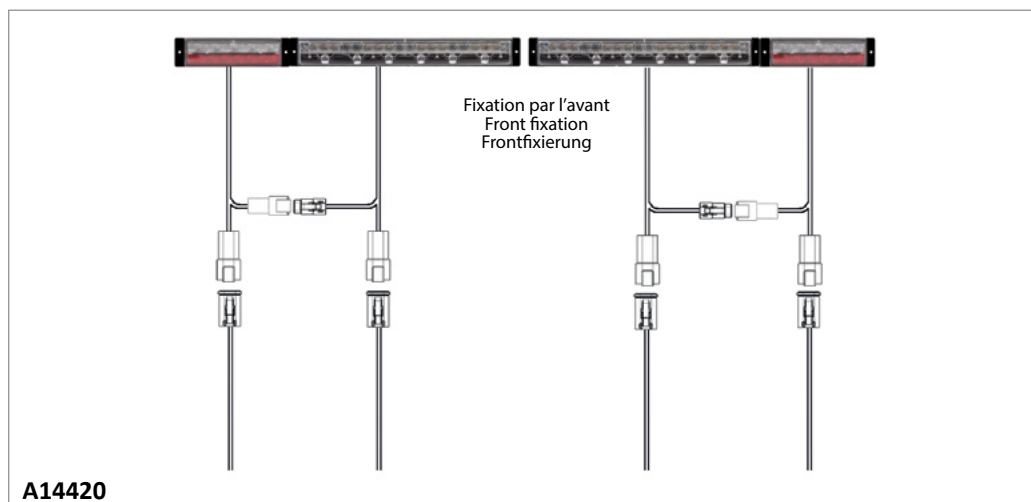

**A14420**

2 x CTL15 + 1 x BL15 gauche + 1 x BL15 droit + 4 câbles 8,5 m  
2 x CTL15 + 1 x left BL15 + 1 x right BL15 + 4 cables 8,5 m  
2 x CTL15 + 1 x BL15 links + 1 x BL15 rechts + 4 Verkabelung 8,5 m

# UD TRUCKS

## QUON - QUESTER

### LC5

 p. 163

05/2015 ->



**153860**  
(OE 261319Z01B) 

**153880 \***  
(OE 261319Z01D) 

gauche - left - links



AMP 1.5-7P-M

arrière  
rear connector  
Anschlussstecker hinten



**153870**  
(OE 261319Z01C) 

**153890 \***  
(OE 261319Z01E) 

droit - right - rechts

\* pas de fonction brouillard  
\* no fog function  
\* ohne Nebelschlussleuchte



**D11868** AMP 1.5-7P-F



**052500**  
(OE 265509Z00A)   
gauche - left - links



**052500**  
(OE 265509Z00A)   
droit - right - rechts

### EPP98

 p. 181

05/2015 ->



**196010**  
(OE 265109Z00A)  
JPT-2P-M



**D13876** JPT-2P-F

### ICDL15

 p. 186

05/2015 ->



**120000**  
(OE 84655961) PY21W - 24V  
SS-2P-M



**D13880** SS-2P-F

## CHL 1 LED p. 242

LED

 12/24V



**D14324**  
(OE 101 4 734)  
gauche - left - links



**DT-6P-M**  
arrière  
rear connector  
Anschlusstecker hinten



**D14325**  
(OE 101 4 735)  
droit - right - rechts



**D14352** **DT-6P-F**

## CARBONLUX p. 230

LED

 10/30V



**D14548**  
(OE 101 1 102)

**DT-2P-M**



**D14170** **DT-2P-F**

## VEGA LED p. 256

LED

 10/30V



**D14508**  
(OE 101 4 681)



**D14509**  
(OE 101 4 211)



## VEGA p. 261

 H1 -12/24V



**D14478**  
(OE 101 2 421)



### LC8

 p. 151

06/2017 ->



**155570**  
(OE 7CA 945 095)  
gauche - left - links



**AMP 1.5-7P-M**  
arrière  
rear connector  
Anschlusstecker hinten



**155580**  
(OE 7CA 945 096)  
droit - right - rechts



**D11868** **AMP 1.5-7P-F**



**055020**  
(OE 7CA 945 111)  
gauche - left - links





**055030**  
(OE 7CA 945 112)  
droit - right - rechts



### LC5

 p. 161

06/2017 ->



**152180**  
(OE 7CA 945 091)  
gauche - left - links



**AMP 1.5-7P-M**  
arrière  
rear connector  
Anschlusstecker hinten



**152180**  
(OE 7CA 945 092)  
droit - right - rechts





**D11868** **AMP 1.5-7P-F**



**052500**  
(OE 5001847153)  
gauche - left - links





**052500**  
(OE 5001847153)  
droit - right - rechts



### LC8

 p. 156

06/2006 ->  
05/2017



**156340**  
(OE 2E0 945 095 A)  
gauche - left - links



**AMP 1.5-7P-M**  
arrière  
rear connector  
Anschlusstecker hinten



**156350**  
(OE 2E0 945 096 A)  
droit - right - rechts



**D11868** **AMP 1.5-7P-F**



**056540**  
(OE 2E0 945 111 A)  
gauche - left - links





**056550**  
(OE 2E0 945 112 A)  
droit - right - rechts



FH

## LC9 LED



p. 142

12/2012 -&gt;

LED

24V

**158030**

(OE 82849894 / 84195505 / 84441766 / 23354972)



gauche - left - links



AMP 1.5-7P-M

latéral  
side connector  
Anschlusstecker seitlich**158050**

(OE 82849923 / 84195521 / 84441768 / 23354974)



droit - right - rechts

**158040**

(OE 82849925 / 84195519 / 84441767 / 23354973)



droit - right - rechts

**D11868**

AMP 1.5-7P-F

**058000**

(OE 82849905)



gauche - left - links

**058000**

(OE 82849905)



droit - right - rechts

## SRD08



p. 185

09/2012 -&gt;

LED

24V

**111000**

(OE 82151157)

gauche - left - links

**111010**

(OE 82151205)

droit - right - rechts

**111020**

(OE 21346521)

gauche - left - links

**111030**

(OE 21346522)

droit - right - rechts



FH 08/2008 -> 09/2012

**LED**

 24V



**107000**  
(OE 82114506 / 82355678 / 84139927)  
gauche - left - links



**107010**  
(OE 82114500 / 82355684 / 84139939)  
droit - right - rechts



**107040**  
(OE 82114504 / 21448885)  
gauche - left - links



**107050**  
(OE 82114502 / 21478751)  
droit - right - rechts



## FE08 H2

09/2012 ->

**LED**

 24V



**112010**  
(OE 82278930)  
gauche - left - links



**112000**  
(OE 82278938)  
droit - right - rechts



## ID08

09/2012 ->

**LED**

 24V



**114000**  
(OE 21214534)



**114010**  
(OE 82150539)



**114020**  
(OE 21214524)



FH

## FE08 H1

09/2012 -&gt;

LED

24V



**116010**  
(OE 82349220)

**116030**  
(OE 21368782)

gauche - left - links



**116000**  
(OE 82349221)



**116020**  
(OE 21368783)

droit - right - rechts



**116040**  
(OE 82348508)

**116050**  
(OE 21368779)

**116060**  
(OE 21368781)



## FE07

08/2008 -&gt;

LED

24V



**207000**  
(OE 82116545)



**207010**  
(OE 21087346)



**207020**  
(OE 21087347)

## SL08

09/2012 -&gt;

5W



**113000**  
(OE 82202076)

Lampe de portière  
Door lamp  
Türleuchte

### ATLAS

 p. 252

04/2021 ->

**NEW**

**LED**

 9/32V



**212730**  
(OE 23742314)



TYCO MCON-2P-M

## FH - FM

### SH3

 p. 237

 H3/70W-24V



**D12111**  
(OE 20872890)

### SHD 1200

 p. 227

05/2014 -> 12/2015

**LED**

 9/36V



**D14161**  
(OE 84185589)

DT-2P-M



**D14170**

DT-2P-F

## FH - FM - FL

### SMD00

 p. 198

2001 ->

**LED**

 24V



**198620**  
(OE 82392733)

**K**

Cuve blanche - cabochon PMMA  
White body - PMMA lens  
Weißes Gehäuse - PMMA Lichtscheibe



**198740**  
(OE 84044658)

**K**

Cuve ambre - cabochon PC haute température  
Amber body - PC lens high temperature  
Oranges Gehäuse - PC Lichtscheibe hoch temperatur beständig



**001766**  
(OE 85105029)

adaptateur - adaptor - adapterkabel

FM



## LC10 LED p. 143

09/2013 ->

LED

 24V





**159500**     
(OE 82483074 / 84441759 /  
23522307 / 23690769)

gauche - left - links





**AMP 1.5-7P-M**  
latéral  
side connector  
Anschlusstecker seitlich



**159530**    
(OE 21735299 / 84441937  
23522305 / 23690765)



droit - right - rechts



**159520**    
(OE 21735301 / 84441936 /  
23522304 / 23690764)

gauche - left - links



**159510**     
(OE 82483073 / 84441760 /  
23522308)

droit - right - rechts



**D11868** **AMP 1.5-7P-F**



**059500**   
(OE 84122332)  
gauche - left - links



**059500**   
(OE 84122332)  
droit - right - rechts

## SRD07 p. 185

09/2010 -> 10/2013

LED

 24V



**107000**  
(OE 82114506 / 82355678)  
gauche - left - links



**107010**  
(OE 82114500 / 82355684)  
droit - right - rechts



**107040**  
(OE 82114504 / 21448885)  
gauche - left - links



**107050**  
(OE 82114502 / 21478751)  
droit - right - rechts

11/2013 ->



**107500**  
(OE 82467736)  
gauche - left - links



**107510**  
(OE 82467737)  
droit - right - rechts

### FE07

08/2008 ->

LED

24V



**207000**  
(OE 82116545)



**207010**  
(OE 21087346)



**207020**  
(OE 21087347)

### LC9

i p. 160

01/2006 ->



**159010**  
(OE 20769775) K FPL EPP  
gauche - left - links



**AMP 1.5-7P-M**  
latéral  
side connector  
Anschlussstecker seitlich



**159020**  
(OE 20769776) K FPL  
droit - right - rechts



**159030**  
(OE 20769777) K FPL  
droit - right - rechts



**D11868** **AMP 1.5-7P-F**



**059000**  
(OE 20802418) K  
gauche - left - links



**059000**  
(OE 20802418) K  
droit - right - rechts



**D12953** K FPL

## FL - FE

### LC5

 p. 161

2006 ->



**152190**  
(OE 20769783)  
gauche - left - links





**AMP 1.5-7P-M**  
arrière  
rear connector  
Anschlusstecker hinten



**152200**  
(OE 20769784)  
droit - right - rechts



**152880**  
(OE 20769781)  
gauche - left - links





**152880**  
(OE 20769782)  
droit - right - rechts





**D11868** **AMP 1.5-7P-F**



**052000**  
(OE 20537280)

**052500**  
(OE 20745060)

gauche - left - links





**052000**  
(OE 20537280)

**052500**  
(OE 20745060)

droit - right - rechts



## ICDL94

 p. 187



**119550**  
(OE 21341202)

**JPT-3P-M**



**001616**  
(OE 20745227)



**D13877** **JPT-3P-F**

## FE95

 p. 193



**195010**  
(OE 20745225)  
gauche - left - links



**195010**  
(OE 20745225)  
droit - right - rechts

## FL - FE

### SH3

 p. 237

- \* Lampe fournie
- \* Bulb included
- \* Inklusiv Glühlampen



**D13019\***  
(OE 21396991)

**DT-2P-M**



**D14170**

**DT-2P-F**

## FL

### EPP98

 p. 181



**196010**  
(OE 20721495)

**JPT-2P-M**



**D13876**

**JPT-2P-F**

### FE02

 p. 193

2006 ->



**102200**  
(OE 20717520)

Clippé - clipped - clip-befestigung

**JPT-2P-M**



**001726**  
(OE 20745066)



**D13876**

**JPT-2P-F**

### FPL93

 p. 200



**193020**  
(OE 20734485 / 84538758)

**JPT-2P-M**



**001726**  
(OE 20745066)



**D13876**

**JPT-2P-F**

## SMD98

 p.197

LED

 24V

-> 2003



**198650**  
(OE 20480486)



JPT-2P-M



**D13876**

JPT-2P-F

## SMD98

 p.203

LED

 24V

-> 2003



**198640**  
(OE 70364301)



JPT-2P-M



**D13876**

JPT-2P-F



# VOLVO CONSTRUCTION

## SMD98

 p.197

**LED**

 24V



**198520**  
(OE 11170068)

**K**

**JPT-2P-M**



**D13876**

**JPT-2P-F**

## CHL1H4

 p.243

 24V  
H4 - PY21 - W5W



**D14320** 12V

**D14322** 24V

gauche - left - links



**DT-6P-M**

arrière  
rear connector  
Anschlussstecker hinten



**D14321** 12V

**D14323** 24V

droit - right - rechts



**D14352**

**DT-6P-F**

## TRI

 p.217



**D10596**  
(OE 23374865)

**K**

# Feux arriere

## Rear lamps

## Heckleuchten

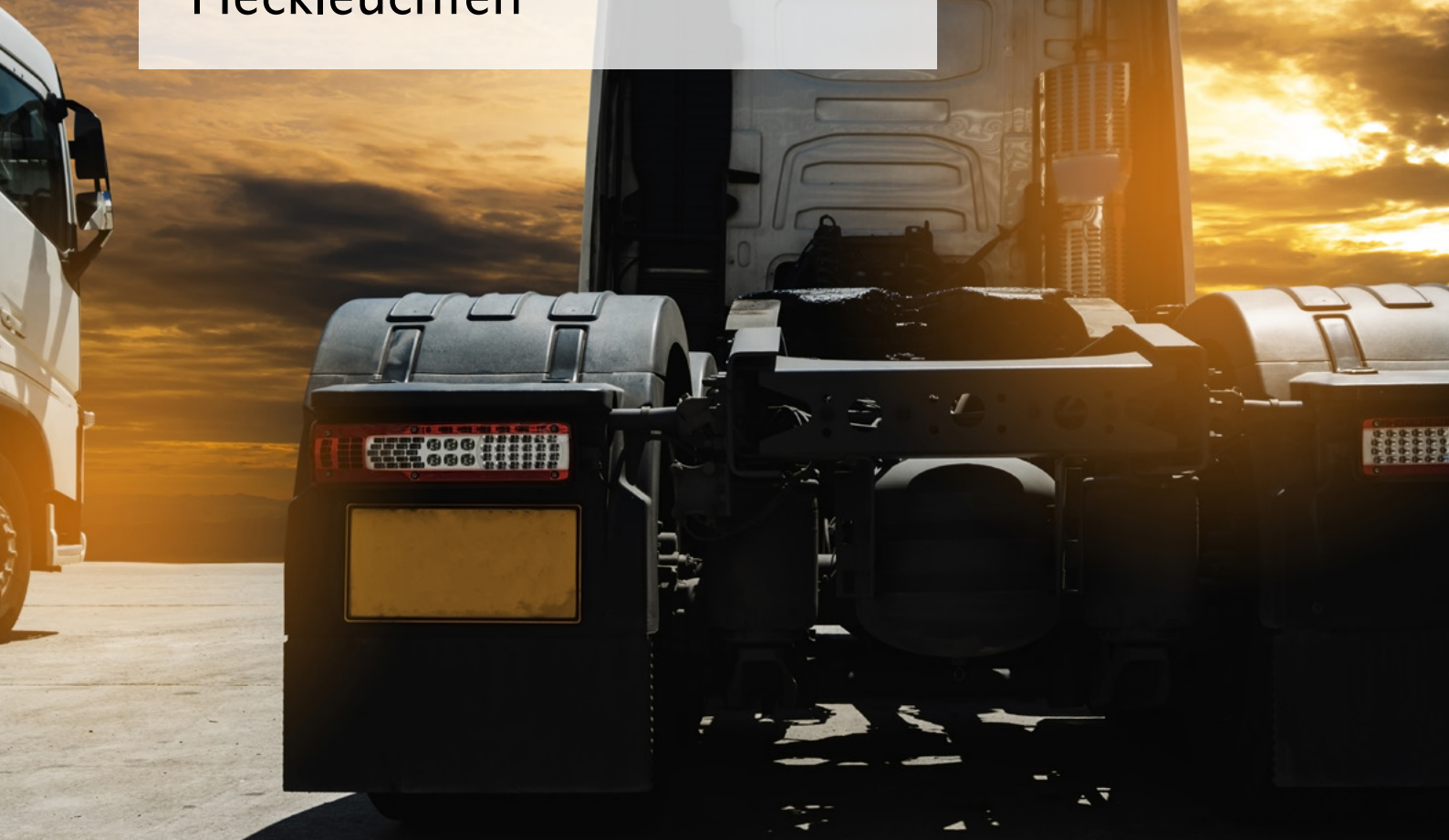

### LED

p. 138-149



**NEW**

### Halogene

p. 150-177



**K** Catadioptr  
Reflector  
Rückstrahler

**T** Catadioptr triangulaire  
Triangular reflector  
Dreieckrückstrahler

**FPL** Feu de position latéral  
Side marker lamp  
seitenmarkierungsleuchte

**EPP** Eclaireur de plaque  
Number plate lamp  
Kennzeichenleuchte

**Al** Alarme sonore de recul  
Back up alarm  
Rückfahrhorn

**+** Connecteurs additionnels  
Additional connectors  
Zusätzliche elektrische anschlüsse

**AMP 1,5-7P-M**



Type connecteur - Nb pins - Mâle ou Femelle  
Connector type - Pins Nb - Male or Female  
Steckertyp - Stifte Nb - männlich oder weiblich

Flashez le QR code pour plus d'infos  
Scan the QR code for more info  
Scannen Sie den QR-Code für weitere Informationen

Pièces détachées  
Spare parts  
Ersatzteile

Numéro d'homologation  
Approval number  
Zulassungsnummer

Sens de montage  
Mounting direction  
Einbaurichtung



Faisceau p. 307  
Harness p. 307  
Anschlusskabel siehe S. p. 307

DETAIL CONNECTEUR 1.5	Support des Connecteurs Pin/Socket	FUNCTION
	1	STOP
	2	POSITION
	3	REDA
	4	INDICATEUR DE DIRECTION
	5	STOP
	6	BRUILLANT
	7	NOT USED

Pinning connecteurs sur notre site web  
Connectors pinning on our website  
Anschlüsse feststecken auf unsere Website

# Feux arriere - Rear lamps - Heckleuchten

## LC12 LED

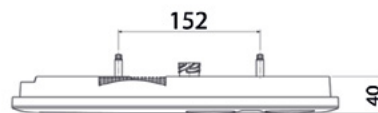
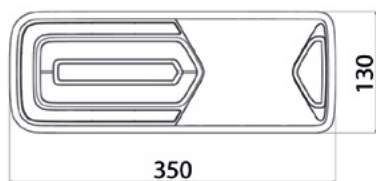

**ORIGINAL**



**LED**

**ADR**



E<sub>2</sub> 16027  
10R-0516057

Affectations constructeurs  
OE applications  
Fahrzeugverwendung

ASCA p. 8  
BENALU p. 12  
DE BUF p. 28  
FELDBINDER p. 32  
FRUEHAUF p. 35  
GUILLEN p. 37  
LAMBERET p. 61  
MAGYAR p. 69  
OMEPS p. 82  
SCHMITZ p. 117  
SOR IBERICA p. 119



**161000** 24V   
**161200** 12V   
gauche - left - links



AMP 1.5-7P-M  
arrière  
rear connector  
Anschlussstecker hinten



**161010** 24V   
**161210** 12V   
droit - right - rechts



**161120** 24V   
**161260** 24V   
**161190** 24V   
gauche - left - links



**161130** 24V   
**161270** 24V   
**161180** 24V   
droit - right - rechts

**GLOWING**



**LED**

**ADR**



E<sub>2</sub> 18042  
10R-0516057



**161280** 24V   
**161420** 12V   
gauche - left - links



AMP 1.5-7P-M  
arrière  
rear connector  
Anschlussstecker hinten



**161290** 24V   
**161430** 12V   
droit - right - rechts



**161500** 24V   
**161560** 24V   
**161460** 24V   
gauche - left - links



**161510** 24V   
**161570** 24V   
**161470** 24V   
droit - right - rechts



ORIGINAL



GLOWING



Clignotant dynamique  
Dynamic indicator  
Dynamisch blinker



4 connecteurs pour options  
4 connectors for options  
4 Anschlüsse für Optionen

Resistance intégrée (contrôle défaillance indicateur)  
Integrated resistance (indicator failure control)  
Integrierter widerstand (blinkleuchtenausfallkontrolle)

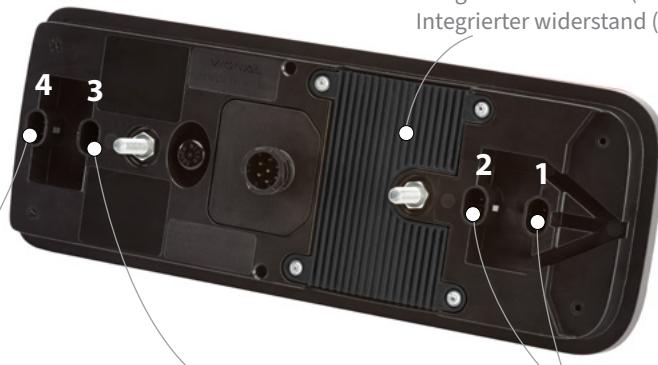

1+2+4 = 1 Amp maxi  
3 = 1 Amp maxi

Position latéral clignotant  
Side marker flashing lamp  
Blinkende seiten markierungs leuchte



Recul  
Reverse  
Rückfahr



Position  
Schlußlicht



CLICK-IN

104090

500 mm



104100

1500 mm



D14857

DT-2P-M



R14364

2000 mm

SS-2P-F



D11868

AMP 1.5-7P-F



SS-2P-F

R14412

16 m



DT-2P-F

SS-2P-F

R14413

1500 mm



D14781

SS-2P-F

gauche - left - links



D14782

SS-2P-F

droit - right - rechts



SS-2P-M

R14426

1500 mm

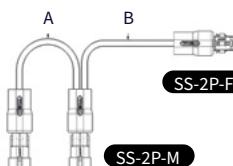

SS-2P-F

SS-2P-M

R14418

A : 300 mm / B: 500 mm



D14425

1500 mm

SS-2P-F

gauche - left - links



D14426

1500 mm

SS-2P-F

droit - right - rechts

Rallonge SUPERSEAL 2 voies  
2 poles SUPERSEAL extension lead  
Verlängerungsschnur Anschlussstecker 2 polig

# Feux arriere - Rear lamps - Heckleuchten

## LC11

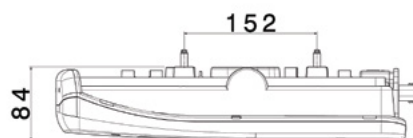
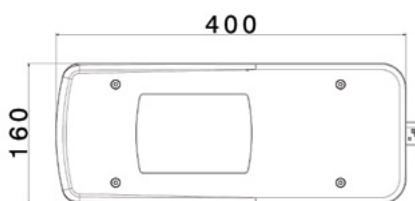

LED

24V

ADR

H

14085  
E<sub>2</sub> 14086 -FPL  
10R-047585

Affectations constructeurs  
OE applications  
Fahrzeugverwendung

IVECO p. 43



**160150**

gauche - left - links

K FPL



HDSCS-8P-M

latéral  
side connector  
Anschlussstecker seitlich



**160100**

droit - right - rechts

K FPL



**160080**

gauche - left - links

K FPL EPP



**160090**

droit - right - rechts

K FPL



**160110**

gauche - left - links

K FPL



HDSCS-8P-M

arrière  
rear connector  
Anschlussstecker hinten



**160130**

droit - right - rechts

K FPL



**160140**

gauche - left - links

K FPL EPP



**160120**

droit - right - rechts

K FPL



**D13878**

HDSCS-8P-F



**060000**

gauche - left - links

K



**060010**

droit - right - rechts

K

# Feux arriere - Rear lamps - Heckleuchten

## LC11

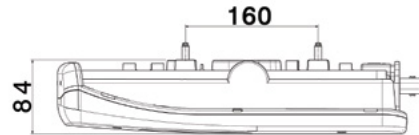
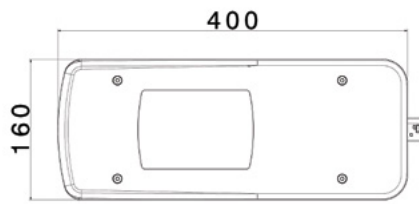

LED

12V

ADR

H

E2  
14085  
14086 -FPL  
10R-047585

Affectations constructeurs  
OE applications  
Fahrzeugverwendung

MERCEDES p. 77



**160400**

gauche - left - links

K FPL EPP



AMP 1.5-7P-M  
arrière  
rear connector  
Anschlussstecker hinten



**160410**

droit - right - rechts

K FPL



**D11868**

AMP 1.5-7P-F



**060000**

gauche - left - links

K



**060010**

droit - right - rechts

K



# Feux arriere - Rear lamps - Heckleuchten

## LC9 LED

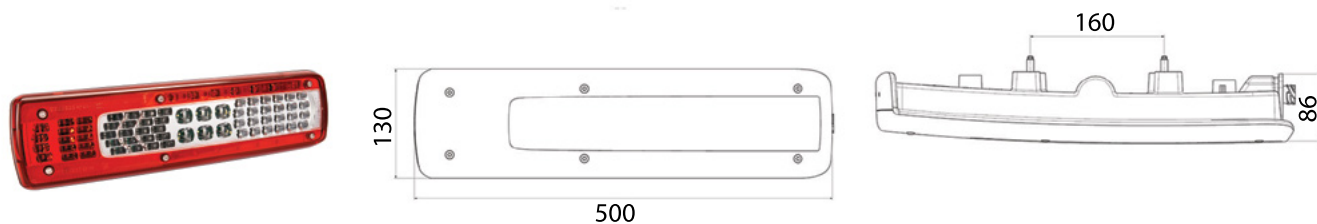

LED

24V



E2 10113  
10R-036227

Affectations constructeurs  
OE applications  
Fahrzeugverwendung

RENAULT TRUCKS p. 86  
VOLVO TRUCKS p. 127



**158030**

gauche - left - links



AMP 1.5-7P-M

latéral  
side connector  
Anschlussstecker seitlich



**158050**

droit - right - rechts



**158040**

droit - right - rechts



**D11868**

AMP 1.5-7P-F



**058000**

gauche - left - links



**058000**

droit - right - rechts



## LC10 LED

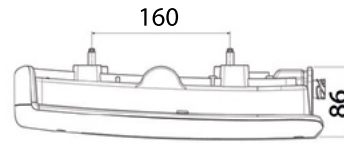

LED

24V



E2 12164  
10R-036854

Affectations constructeurs  
OE applications  
Fahrzeugverwendung

RENAULT TRUCKS p. 87  
VOLVO TRUCKS p. 131



**159520**

gauche - left - links



AMP 1.5-7P-M

latéral  
side connector  
Anschlusstecker seitlich



**159530**

droit - right - rechts



**159500**

gauche - left - links



**159510**

droit - right - rechts



**D11868**

AMP 1.5-7P-F



**059500**

gauche - left - links



**059500**

droit - right - rechts



# Feux arriere - Rear lamps - Heckleuchten

## CTL15



LED

24V

1200 Lumen



E<sub>2</sub> 16005

Affectations constructeurs  
OE applications  
Fahrzeugverwendung

CHEREAU p. 19  
LECAPITAINE p. 65  
TROUILLET p. 123

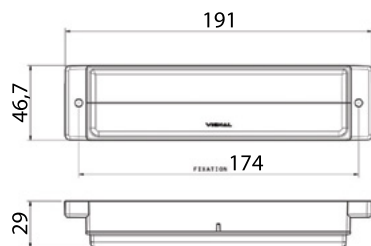

DT04-4P-M



Fixation par l'arrière  
Back fixation  
Rückenfixierung

**164000**

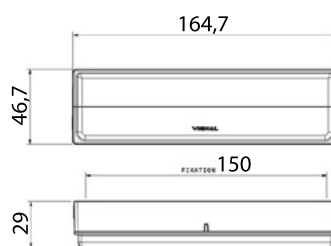

DT04-4P-M



DTM04-4P-M



**164010**

Pour raccordement sur feu BL15  
To plug in BL15 lamp  
Zum direkten Anschluss an die leuchte BL15



DT04-4P-M



Fixation par l'avant  
Front fixation  
Frontfixierung

**164020**



DT04-4P-M



DTM04-4P-M



**164030**

Pour raccordement sur feu BL15  
To plug in BL15 lamp  
Zum direkten Anschluss an die leuchte BL15

## BL15



LED

24V



E<sub>2</sub> 16007  
10R-0516079

Affectations constructeurs  
OE applications  
Fahrzeugverwendung

CHEREAU p. 19  
FRUEHAUF p. 35  
LECAPITAINE p. 65  
TROUILLET p. 123

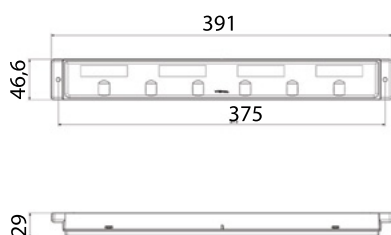

DT04-4P-M



Fixation par l'arrière  
Back fixation  
Rückenfixierung

**165020**

gauche - left - links



DTM06-4S-4P-F



**165030**

droit - right - rechts



Fixation par l'avant  
Front fixation  
Frontfixierung

**165040**

gauche - left - links



**165050**

droit - right - rechts

## CTL15 - BL15



Indicateur de direction à défilement - feux de détresse flash  
 Dynamic indicator lights - warning lights  
 Dynamischer Blinker - blinkende Warnleuchte



Feu de travail 1200 Lumen  
 Work light 1200 Lumen  
 Arbeitsscheinwerfer 1200 Lumen

Stop et position  
 Stop and position  
 Bremsleuchte und Schlussleuchte



## CTL15 - BL15

LED

24V

1200 Lumen



16005  
 16007  
 10R-0516079

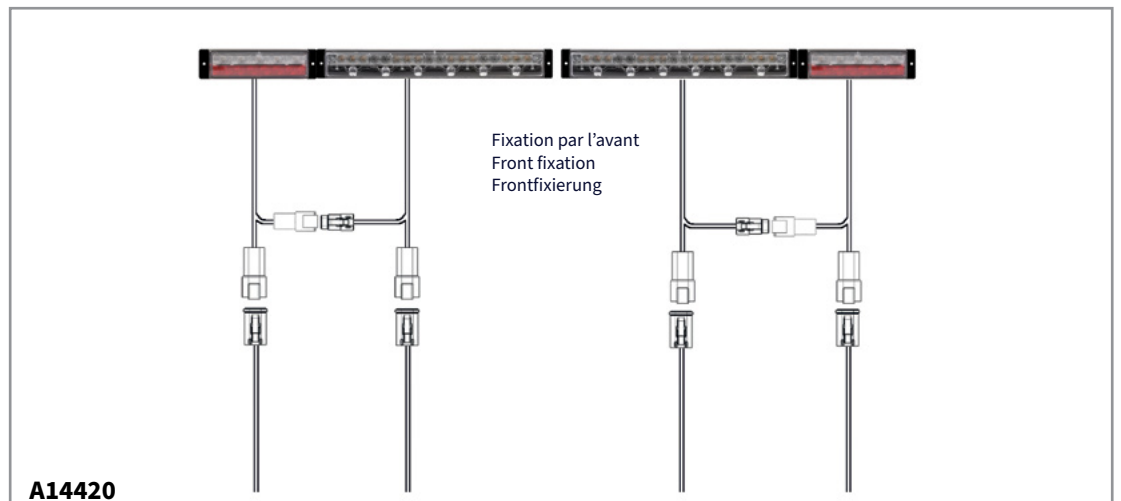

2 x CTL15 + 1 x BL15 gauche + 1 x BL15 droit + 4 câbles 8,5 m  
 2 x CTL15 + 1 x left BL15 + 1 x right BL15 + 4 cables 8,5 m  
 2 x CTL15 + 1 x BL15 links + 1 x BL15 rechts + 4 Verkabelung 8,5 m

# Feux arriere - Rear lamps - Heckleuchten

## LCR19

### GLOWING

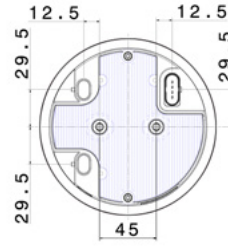
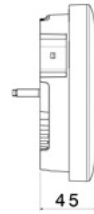
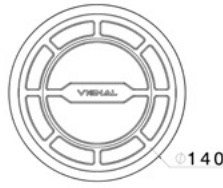

### NEW

LED

24V

H

E<sub>2</sub> 19106

Affectations constructeurs  
OE applications  
Fahrzeugverwendung

SCHMITZ p. 117



213010

AMP MCP-4P-M

Position Glowing - Stop - Clignotant  
Glowing position - Stop - Indicator  
Glowing Schlusslicht - Bremslicht - Blinker



213070

AMP MCP-4P-M

Position Glowing - Stop - Clignotant  
Glowing position - Stop - Indicator  
Glowing Schlusslicht - Bremslicht - Blinker



213090

AMP MCP-4P-M

Position Glowing - Stop - Clignotant  
Glowing position - Stop - Indicator  
Glowing Schlusslicht - Bremslicht - Blinker

RI

SMC

POS



POS

POS



Connecteurs additionnels Superseal 2 voies mâle  
Additional connectors Superseal 2 pin male  
Zusätzliche elektrische anschlüsse Superseal Männlich 2 polig

### NEW

R23



213150

AMP MCP-4P-M

Recul - Brouillard  
Reverse - Fog  
Rückfahrlicht - Nebelschlusslicht



213160

AMP MCP-4P-M

Recul - Brouillard  
Glowing position - Stop - Indicator  
Glowing Schlusslicht - Bremslicht - Blinker



213200

AMP MCP-4P-M

Position Glowing - Recul - Brouillard  
Glowing position - Reverse - Fog  
Glowing Schlusslicht - Rückfahrlicht - Nebelschlusslicht



002100

Anneau chromé  
Chrome ring  
Chromring



\* SMC  
Position latéral clignotant  
Side marker flashing lamp  
Blinkende seiten markierungs leuchte

POS  
Position  
Schlußlicht

R23  
Recul  
Reverse  
Rückfahr

RI  
Resistance intégrée (contrôle défaillance indicateur)  
Integrated resistance (indicator failure control)  
Integrierter widerstand (blinkleuchtenausfallkontrolle)

## LCR19



<b>D14984</b>	AMP-MCP-4P-F	<b>D14980</b>	AMP 1.5-7P-M	<b>D14983</b>
	AMP-MCP-4P-F			AMP-MCP-4P-F

Affectations constructeurs  
OE applications  
Fahrzeugverwendung  
[SCHMITZ p. 117](#)

<b>D14846</b>	<b>D14847</b>	<b>D14884</b>	<b>D14885</b>
gauche - left - links	droit - right - rechts	gauche - left - links	droit - right - rechts

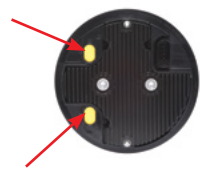

<b>SMC</b>		<b>POS</b>		<b>POS</b>		<b>POS</b>	
	<b>CLICK-IN</b>		<b>SS-2P-F</b>		<b>SS-2P-F</b>		<b>SS-2P-F</b>
<b>104090</b>	500 mm <b>K</b>	<b>R14364</b>	2000 mm	<b>D14425</b>	1500 mm	<b>D14426</b>	1500 mm
<b>104100</b>	1500 mm <b>K</b>			gauche - left - links		droit - right - rechts	

<b>R14412</b>	16 m	<b>R14426</b>	1500 mm
		<b>R14418</b>	A: 300 mm / B: 500 mm

Rallonge SUPERSEAL 2 voies  
2 poles SUPERSEAL extension lead  
Verlängerungsschnur Anschlussstecker 2 polig

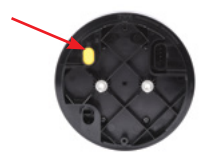

<b>R23</b>	<b>DT-2P-M</b>	<b>SS-2P-F</b>
<b>D14857</b>		<b>R14413</b>
		1500 mm

\* **SMC** Position latéral clignotant / Side marker flashing lamp / Blinkende seiten markierungs leuchte  
**POS** Position / Schlußlicht  
**R23** Resistance intégrée (contrôle défaillance indicateur) / Integrated resistance (indicator failure control) / Integrierter widerstand (blinkleuchtenausfallkontrolle)  
**RI** Resistance intégrée (contrôle défaillance indicateur) / Integrated resistance (indicator failure control) / Integrierter widerstand (blinkleuchtenausfallkontrolle)

# Feux arriere - Rear lamps - Heckleuchten

## CTL14

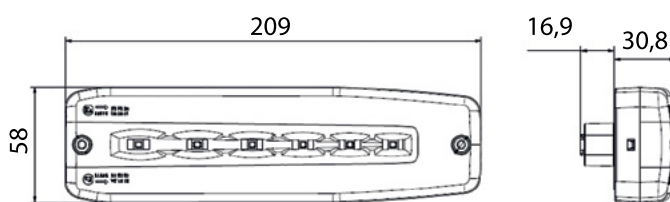

LED

12/24V



E2 16111  
10R-17254



**DT04-4P-M**  
arrière  
rear connector  
Anschlussstecker hinten



**D14436** DT06-4S-4P-F

**163010**

gauche/droit - left/right - links/rechts



Stop - position - clignotant dynamique  
Stop - position - dynamic direction indicator  
Bremsleuchte - Schlussleuchte - Dynamisch wischender blinker



## SLIM

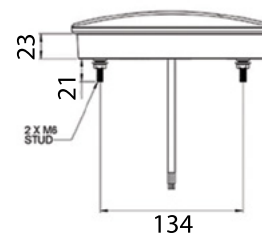
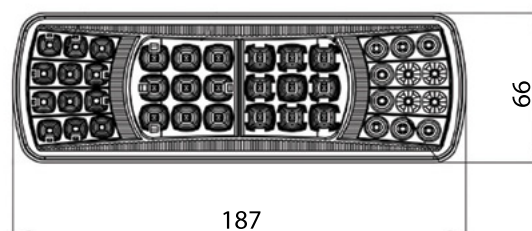

LED

12/24V



E9 11734  
10R-051614

\* fils nus - naked cable extre-  
mity - Kabellitze



5 FONCTIONS - FUNCTIONS - FUNKTIONEN

**D13817\***

gauche/droit - left/right - links/rechts



Stop - position - clignotant - recul - antibrouillard  
Stop - position - direction indicator - reverse - fog  
Bremsleuchte - Schlussleuchte - Blinker - Rückfahrleuchte - Ne-  
belschlussleuchte



## FRR

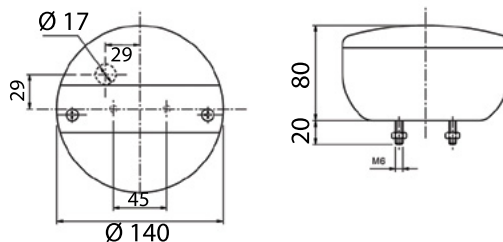

LED

12/24V



13992  
E4 23271  
4052



IP67

\* cosses plates - flat plugs -  
Flachstecker



**D13816 \***  
gauche/droit - left/right - links/rechts



**D14189 \***  
feu de recul  
reverse lamp  
rückfahrleuchte



**D14188 \***  
feu de brouillard  
fog lamp  
nebelschlussleuchte



Stop - position - clignotant  
Stop - position - direction indicator  
Bremsleuchte - Schlussleuchte - Blinker

## FRR

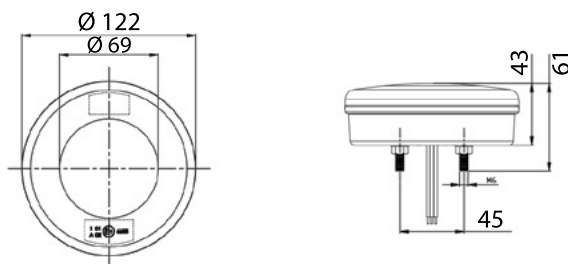

LED

12/24V



6653  
E9 1288  
10R-041489  
10R-041487



IP67

\* fils nus - naked cable extre-  
mity - Kabellitze



**D14348\***  
gauche/droit - left/right - links/rechts



**D14345\***  
feu de recul - brouillard  
reverse - fog lamp  
rückfahrleuchte - nebelschlussleuchte



Stop - position - clignotant  
Stop - position - direction indicator  
Bremsleuchte - Schlussleuchte - Blinker

# Feux arriere - Rear lamps - Heckleuchten

## LC8

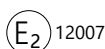
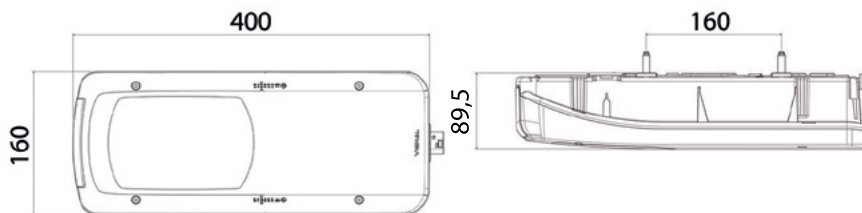

Affectations constructeurs  
OE applications  
Fahrzeugverwendung

DAF p. 23



**155100**

gauche - left - links



**HDSCS-8P-M**

latéral  
side connector  
Anschlussstecker seitlich



**155110**

droit - right - rechts



**155120**

droit - right - rechts



**155130**

gauche - left - links



**HDSCS-8P-M**

arrière  
rear connector  
Anschlussstecker hinten



**155140**

droit - right - rechts



**155150**

droit - right - rechts



**D13878**

**HDSCS-8P-F**



**055020**

gauche - left - links



**055030**

droit - right - rechts



**001830**



## LC8

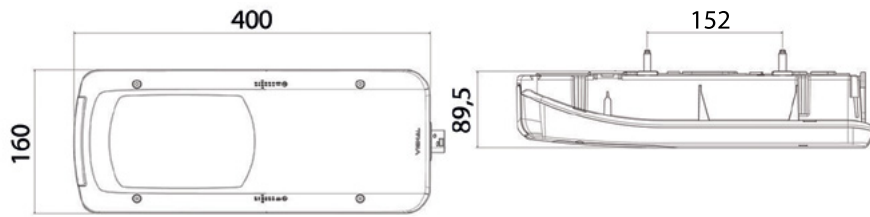

E2 12007

Affectations constructeurs  
OE applications  
Fahrzeugverwendung

VOLKSWAGEN p. 126



**155570**

gauche - left - links



AMP 1.5-7P-M  
arrière  
rear connector  
Anschlussstecker hinten



**155580**

droit - right - rechts



**D11868**

AMP 1.5-7P-F



**055020**

gauche - left - links



**055030**

droit - right - rechts





# Feux arriere - Rear lamps - Heckleuchten

## LC8

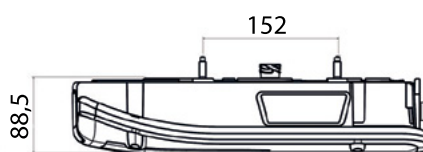
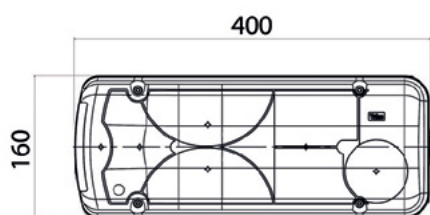

Affectations constructeurs  
OE applications  
Fahrzeugverwendung  
IVECO p. 44

DESIGN EFFET FUMÉ - MÉTALLISÉ  
SMOKED EFFECT & METTALIZED DESIGN



**155450**

gauche - left - links



HDSCS-8P-M

latéral  
side connector  
Anschlusstecker seitlich



**155460**

droit - right - rechts



**155470**

droit - right - rechts



**155480**

gauche - left - links



HDSCS-8P-M

arrière  
rear connector  
Anschlusstecker hinten



**155490**

droit - right - rechts



**155540**

gauche - left - links



**155500**

droit - right - rechts



**D13878**

HDSCS-8P-F



**055040**

gauche - left - links



**055050**

droit - right - rechts



**001830**



# Feux arriere - Rear lamps - Heckleuchten

## LC8

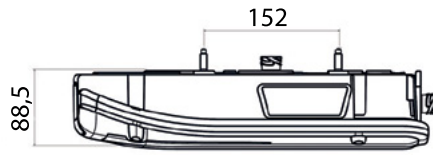
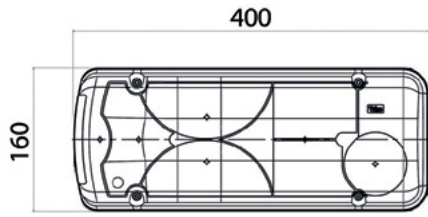

Affectations constructeurs  
OE applications  
Fahrzeugverwendung

MAN p. 70



**156200**

gauche - left - links



AMP 1.5-7P-M

latéral  
side connector  
Anschlusstecker seitlich



**156210**

droit - right - rechts



**001872** 55-90 db



**156220**

droit - right - rechts



Affectations constructeurs  
OE applications  
Fahrzeugverwendung

MAN (TGE) p. 71

\* vis arrière de 31 mm  
\* 31 mm rear bolts  
\* hintere Schraube 31 mm



**155550** \*

gauche - left - links

12V



AMP 1.5-7P-M

arrière  
rear connector  
Anschlusstecker hinten



**155560** \*

droit - right - rechts

12V



**D11868**

AMP 1.5-7P-F

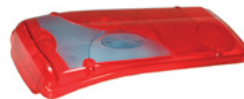

**056500**

gauche - left - links

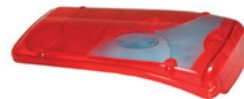

**056510**

droit - right - rechts

# Feux arriere - Rear lamps - Heckleuchten

## LC8

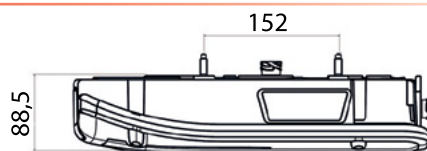
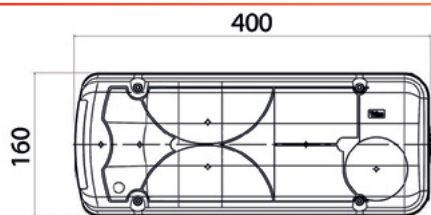

ADR



E<sub>2</sub> 2040

Affectations constructeurs  
OE applications  
Fahrzeugverwendung  
CHEREAU p. 20  
LAMBERET p. 62



**156550**

gauche - left - links

FPL



AMP 1.5-7P-M

arrière  
rear connector  
Anschlussstecker hinten

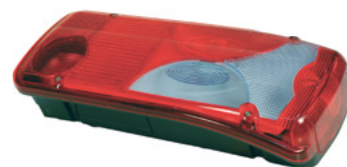

**156540**

droit - right - rechts

FPL



**156310**

gauche - left - links

K FPL

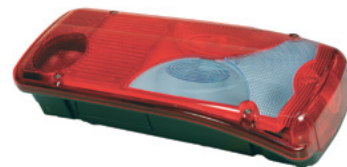

**156300**

droit - right - rechts

K FPL



**156290**

gauche - left - links

K FPL EPP



**D11868**

AMP 1.5-7P-F

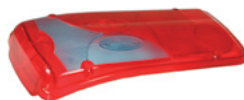

**056000**

**056500**

gauche - left - links

K



**056010**

**056510**

droit - right - rechts

K

## LC8

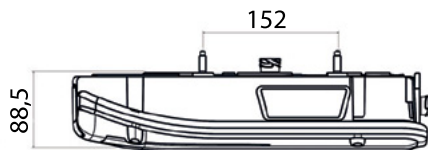
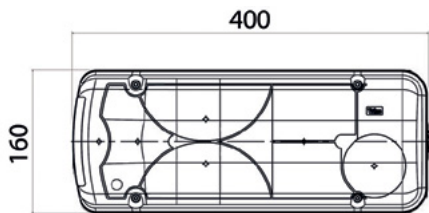

Affectations constructeurs  
OE applications  
Fahrzeugverwendung

SCANIA p. 115



**156770**

gauche - left - links



**AMP 1.5-7P-M**

latéral  
side connector  
Anschlusstecker seitlich



**156780**

droit - right - rechts



**155020**

gauche - left - links



**156790**

droit - right - rechts



**155080**

gauche - left - links



**AMP 1.5-7P-M**

arrière  
rear connector  
Anschlusstecker hinten



**155520**

droit - right - rechts



**155090**

droit - right - rechts



**D11868**

**AMP 1.5-7P-F**



**056540**

gauche - left - links



**056550**

droit - right - rechts



**001830**



# Feux arriere - Rear lamps - Heckleuchten

## LC8

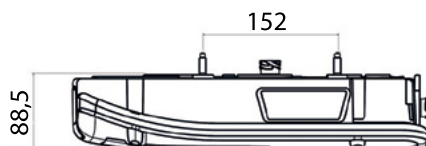
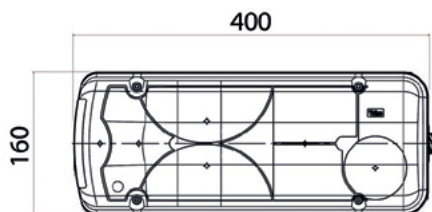

Affectations constructeurs  
OE applications  
Fahrzeugverwendung

MERCEDES p. 77  
VOLKSWAGEN p. 126



**156590**

gauche - left - links



AMP 1.5-7P-M

arrière  
rear connector  
Anschlussstecker hinten



**156600**

droit - right - rechts



**156340**

gauche - left - links



**156350**

droit - right - rechts



**D11868**

AMP 1.5-7P-F



**056020**

**056540**

gauche - left - links



**056030**

**056550**

droit - right - rechts



## LC8T

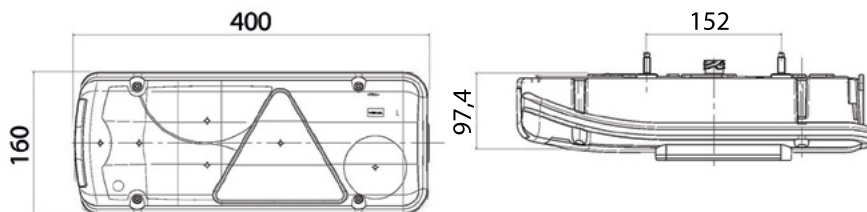

Affectations constructeurs  
OE applications  
Fahrzeugverwendung

ASCA p. 8  
BENALU p. 12  
CHEREAU p. 20  
FRUEHAUF p. 35  
GUILLEN p. 37  
LAMBERET p. 61  
SOR IBERICA p. 119



**156040**

gauche - left - links



AMP 1.5-7P-M

arrière  
rear connector  
Anschlusstecker hinten



**156050**

droit - right - rechts



**156060**

gauche - left - links



**156070**

droit - right - rechts



**156130**

droit - right - rechts



**156630**

gauche - left - links



AMP 1.5-7P-M

latéral  
side connector  
Anschlusstecker seitlich



**156640**

droit - right - rechts



**Repiquage fonctions stop et positions**  
**Plug-in stop and positions functions**  
**Anschluss zusätzliche Brems und Positionsluchten**

Pour - For - Für :

156040 - 156050 - 156060 - 156070 - 156130 - 156170 - 156250 - 156260 - 156290 - 156300 - 156310 - 156380 - 156390 - 156540 - 156550 - 156590 - 156600

Câblage - Harness - Anschlusskabel p. 300

# Feux arriere - Rear lamps - Heckleuchten

## LC8



Affectations constructeurs  
OE applications  
Fahrzeugverwendung

ASCA p. 8  
BENALU p. 12  
CHEREAU p. 20  
FRUEHAUF p. 35  
GUILLEN p. 37  
LAMBERET p. 61  
SOR IBERICA p. 119



**D11868** AMP 1.5-7P-F



**056700**  
gauche - left - links



**056710**  
droit - right - rechts



**001830**



**001846**  
cales - spacers - abstandhalter

LED

12/24V



**D14038** 500 mm  
gauche - left - links



**D14037** 500 mm  
droit - right - rechts



**D14039** 350 mm  
gauche - left - links



**D14040** 350 mm  
droit - right - rechts

W5W

12/24V



**D13034** 500 mm  
gauche - left - links



**D13035** 500 mm  
droit - right - rechts



**D12712** 350 mm  
gauche - left - links



**D12711** 350 mm  
droit - right - rechts

## LC8T

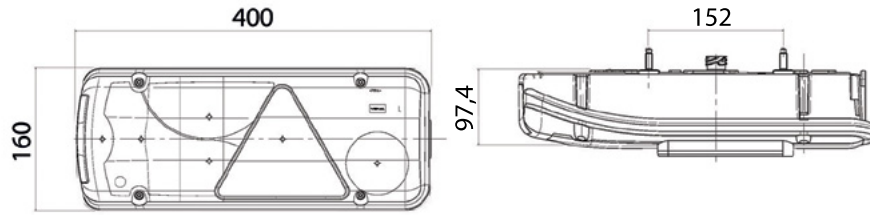

Affectations constructeurs  
OE applications  
Fahrzeugverwendung

FELDBINDER p. 32  
LECIÑENA p. 66



**156250**

gauche - left - links



AMP 1.5-7P-M

arrière  
rear connector  
Anschlusstecker hinten



**156260**

droit - right - rechts



**156380**

gauche - left - links



**156390**

droit - right - rechts



**D11868**

AMP 1.5-7P-F



**056720**

gauche - left - links



**056730**

droit - right - rechts





# Feux arriere - Rear lamps - Heckleuchten

## LC9

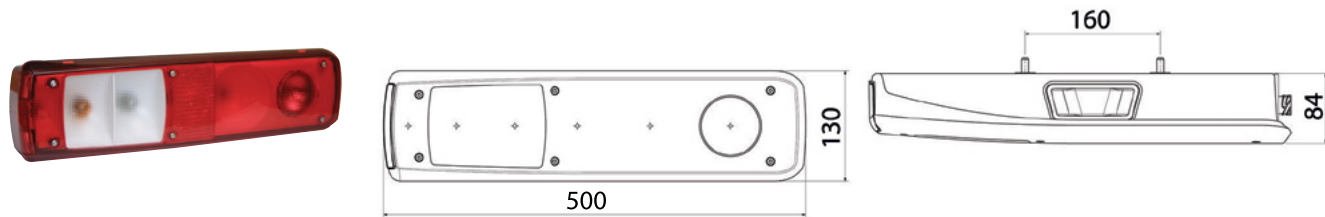

E<sub>2</sub> 04075

Affectations constructeurs  
OE applications  
Fahrzeugverwendung

RENAULT TRUCKS p. 87  
VOLVO TRUCKS p. 132



**159010**

gauche - left - links



AMP 1.5-7P-M

latéral  
side connector  
Anschlussstecker seitlich



**159020**

droit - right - rechts



**159030**

droit - right - rechts



**D11868**

AMP 1.5-7P-F



**059000**

gauche - left - links



**059000**

droit - right - rechts



**D12953**



## LC5

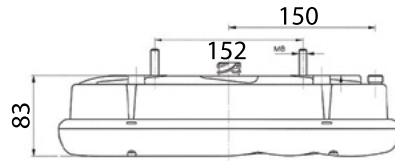
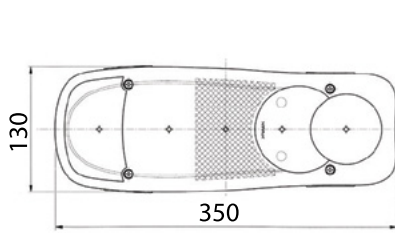

E<sub>2</sub> 8005

Affectations constructeurs  
OE applications  
Fahrzeugverwendung

BOBCAT p. 15  
DAF p. 25  
IVECO p. 49  
MANITOU p. 73  
MANITOWOC p. 75  
NISSAN p. 81  
OPEL p. 84  
RENAULT TRUCKS p. 99  
VOLKSWAGEN p. 126  
VOLVO TRUCKS p. 133



**152130**

**152150**

gauche - left - links



PG 13

arrière  
rear connector  
Anschlussstecker hinten



**152130**

**152150**

droit - right - rechts



**152160**

**152140**

gauche - left - links



AMP 1.5-7P-M

arrière  
rear connector  
Anschlussstecker hinten



**152200**

**152180**

droit - right - rechts



**152190**

**152170**

gauche - left - links



**153120**

droit - right - rechts



**D11868**

AMP 1.5-7P-F



**052000**

**052500**

gauche - left - links



**052000**

**052500**

droit - right - rechts



**D13288**

grille de protection réversible  
homologuée - homologated  
protective grid - Schutzgitter  
genehmigt

# Feux arriere - Rear lamps - Heckleuchten

## LC5

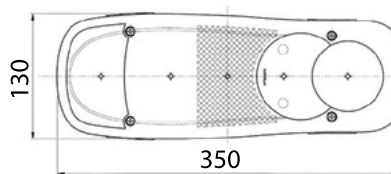

E<sub>2</sub> 8005

Affectations constructeurs  
OE applications  
Fahrzeugverwendung

FIAT p. 34  
PEUGEOT CITROËN p. 85



Fixation 4 vis M6 (190x60mm)  
Fixing 4 screws M6 (190x60mm)  
Befestigung 4 Schrauben M6  
(190x60mm)



**153270**

gauche - left - links



AMP 1.5-7P-M

arrière  
rear connector  
Anschlussstecker hinten



**153280**

droit - right - rechts



**D11868**

AMP 1.5-7P-F



**052500**

gauche - left - links



**052500**

droit - right - rechts



# Feux arriere - Rear lamps - Heckleuchten

LC5

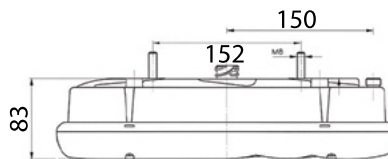
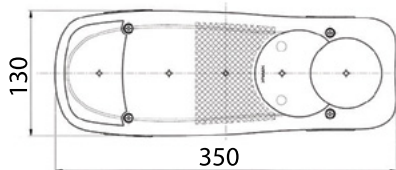

Affectations constructeurs  
OE applications  
Fahrzeugverwendung

IVECO p. 45



**153220**

gauche - left - links



AMP 1.5-7P-M

arrière  
rear connector  
Anschlusstecker hinten



**153210**

droit - right - rechts



**153200**

gauche - left - links

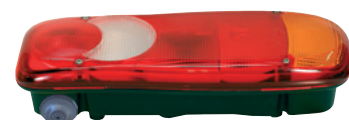

**153230**

droit - right - rechts



**153240**

gauche - left - links



**153250**

droit - right - rechts



**153260**

droit - right - rechts



**D11868**

AMP 1.5-7P-F



**052500**

gauche - left - links



**052500**

droit - right - rechts



# Feux arriere - Rear lamps - Heckleuchten

## LC5T

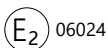
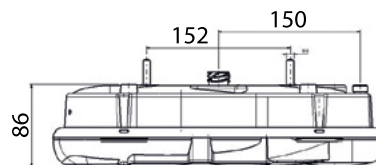
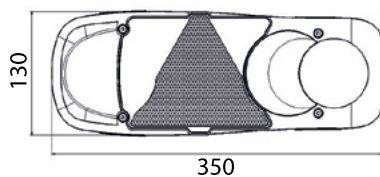

Affectations constructeurs  
OE applications  
Fahrzeugverwendung

ASCA p. 9  
LAMBERET p. 62  
LECIÑENA p. 66



**153040**

gauche - left - links



PG 13

arrière  
rear connector  
Anschlussstecker hinten



**153050**

droit - right - rechts



**153060**

gauche - left - links



**153070**

droit - right - rechts



**153000**

gauche - left - links



AMP 1.5-7P-M

arrière  
rear connector  
Anschlussstecker hinten



**153010**

droit - right - rechts



**153130**

droit - right - rechts



**153020**

gauche - left - links



**153030**

droit - right - rechts



**D11868**

AMP 1.5-7P-F

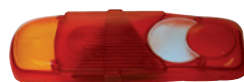

**053700**

gauche - left - links

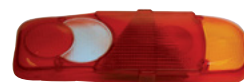

**053710**

droit - right - rechts



## LC5TDX

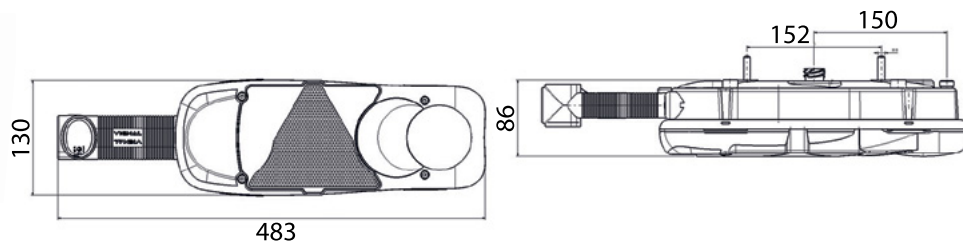

E2 06024 (sans DX)  
07092 (avec DX)

Affectations constructeurs  
OE applications  
Fahrzeugverwendung

ASCA p. 9



**153660**

gauche - left - links



AMP 1.5-7P-M

arrière  
rear connector  
Anschlussstecker hinten



**153670**

droit - right - rechts



**153700**

gauche - left - links



**153710**

droit - right - rechts



**D11868**

AMP 1.5-7P-F

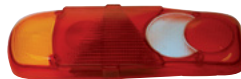

**053700**

gauche - left - links



**053710**

droit - right - rechts



**D12430**



**D12471**



**D12472**

Lampe non fournie - bulb  
not included - nichte inklusiv  
glühlampen



**D12473**

# Feux arriere - Rear lamps - Heckleuchten

## LC7

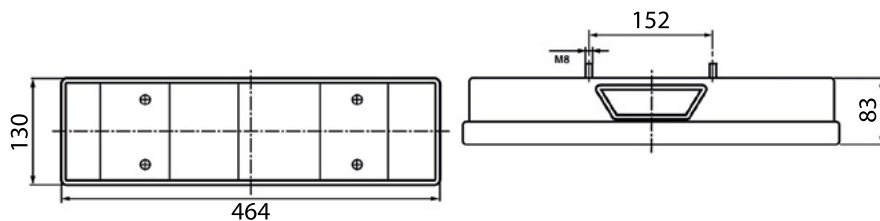

E2 88017 (LC7)  
88035 (LC7K)

Affectations constructeurs  
OE applications  
Fahrzeugverwendung

RENAULT TRUCKS p. 91



**167100**

EPP

**167600**

K EPP

gauche - left - links



PE  
arrière  
rear connector  
Anschlussstecker hinten



**167000**

**167500**

K

gauche - left - links



**168270**

K FPL

gauche - left - links



**168270**

K FPL

droit - right - rechts



**168340**

K FPL EPP

gauche - left - links

Affectations constructeurs  
OE applications  
Fahrzeugverwendung

MAN p. 71



**168090**

K FPL

gauche - left - links



DIN 72480-8P-M  
arrière  
rear connector  
Anschlussstecker hinten



**168090**

K FPL

droit - right - rechts



**168100**

K FPL EPP

gauche - left - links



**067000**

**067500**

gauche - left - links



**067000**

**067500**

droit - right - rechts

# Feux arriere - Rear lamps - Heckleuchten

## LC7

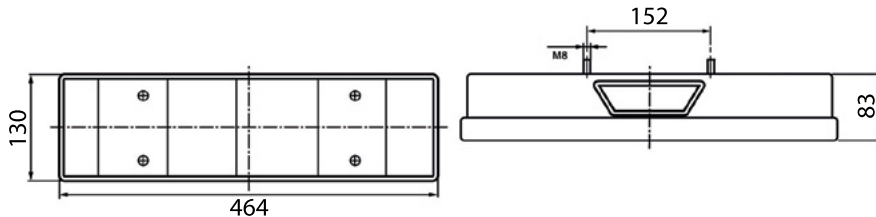

E<sub>2</sub> 88035 (LC7K)

Affectations constructeurs  
OE applications  
Fahrzeugverwendung

DAF p. 24  
MAN p. 72

Affectations constructeurs  
OE applications  
Fahrzeugverwendung

IVECO p. 48

EURO 5



**169180** K FPL  
gauche - left - links



**AMP 1.5-7P-M**  
latéral  
side connector  
Anschlusstecker seitlich



**169170** K FPL  
**169190** K FPL Speaker  
droit - right - rechts



**169160** K FPL EPP  
gauche - left - links



**IVECO**  
arrière  
rear connector  
Anschlusstecker hinten



**168590** K FPL  
gauche - left - links



**168600** K FPL  
droit - right - rechts



**168610** K FPL EPP  
gauche - left - links



**168480** K FPL Speaker  
droit - right - rechts



**D11868** **AMP 1.5-7P-F**



**067500** K  
gauche - left - links



**067500** K  
droit - right - rechts



# Feux arriere - Rear lamps - Heckleuchten

## LC7

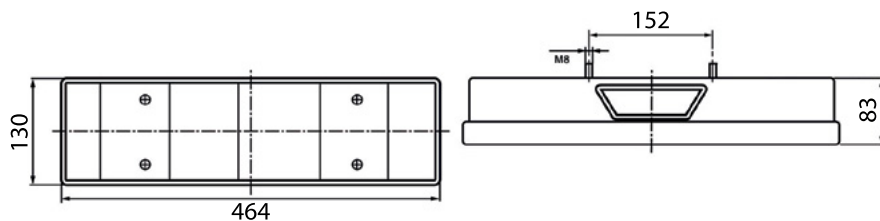

E<sub>2</sub> 88035 (LC7K)

Affectations constructeurs  
OE applications  
Fahrzeugverwendung

DAF p. 24

Affectations constructeurs  
OE applications  
Fahrzeugverwendung

IVECO p. 46

EURO 6



**168020**

gauche - left - links



DAF  
arrière  
rear connector  
Anschlussstecker hinten



**168010**

droit - right - rechts



**169390**

gauche - left - links



DIN 72480-8P-M  
arrière  
rear connector  
Anschlussstecker hinten



**169410**

droit - right - rechts



**169400**

gauche - left - links



**169420**

droit - right - rechts



**D11868**

AMP 1.5-7P-F



**067500**

gauche - left - links



**067500**

droit - right - rechts



**D12953**



## LC7T

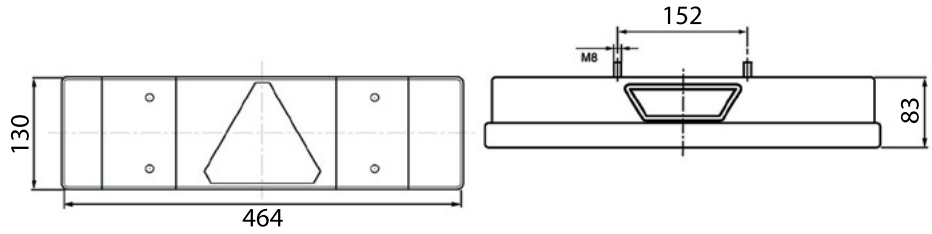

9056



**167530**



**168770**



gauche - left - links



PE  
arrière  
rear connector  
Anschlussstecker hinten



**167550**



**168790**



droit - right - rechts



**168780**



gauche - left - links



**168800**



droit - right - rechts



**168830**



droit - right - rechts



**067610**



gauche - left - links



**067600**



droit - right - rechts

# Feux arriere - Rear lamps - Heckleuchten

## LC6

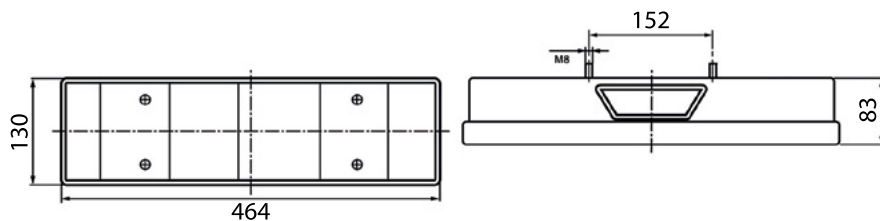

E2 88033 (LC6)  
88034 (LC6K)

Affectations constructeurs  
OE applications  
Fahrzeugverwendung

HEULIEZ p. 39  
IVECO BUS p. 55  
MAN p. 72  
RENAULT TRUCKS p. 91



**166000**

gauche - left - links



PE  
arrière  
rear connector  
Anschlussstecker hinten



**166000**

droit - right - rechts



**166100**

gauche - left - links



**166100**

droit - right - rechts



**166600**

gauche - left - links



**166600**

droit - right - rechts



**066000**

**066500**  
gauche - left - links



**066000**

**066500**  
droit - right - rechts



**001706**

silent blocs - schwingungsdämpfer

## LC4

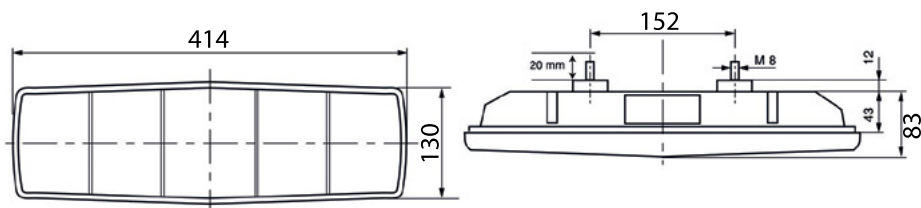

E2 91098 (LC4)  
91099 (LC4K)

Affectations constructeurs  
OE applications  
Fahrzeugverwendung

DAF p. 27  
RENAULT TRUCKSp. 108



**141000** EPP  
gauche - left - links



PE  
arrière  
rear connector  
Anschlussstecker hinten



**141000** EPP  
droit - right - rechts



**141500** K EPP  
gauche - left - links



**141500** K EPP  
droit - right - rechts



**040000**  
**040500** K  
gauche - left - links



**040000**  
**040500** K  
droit - right - rechts



**000046**  
silent blocs - schwingungsdämpfer

# Feux arriere - Rear lamps - Heckleuchten

## 725



E13 8434

Affectations constructeurs  
OE applications  
Fahrzeugverwendung

IVECO p. 50

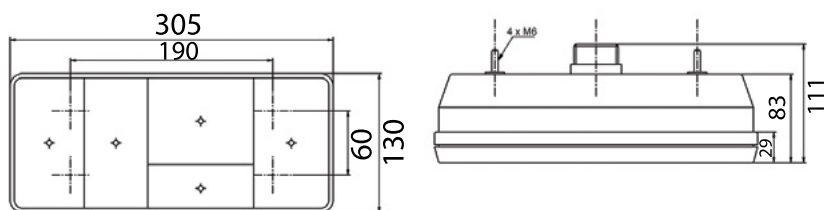

**D11482**  
gauche - left - links



**AMP 1.5-5P-M**  
arrière  
rear connector  
Anschlussstecker hinten



**D11481**  
droit - right - rechts



**D11868** **AMP 1.5-7P-F**



**D11480**  
gauche - left - links



**D11479**  
droit - right - rechts



E13 2060

Affectations constructeurs  
OE applications  
Fahrzeugverwendung

IVECO p. 50



**D12334**  
gauche - left - links



**AMP 1.5-6P-M**  
arrière  
rear connector  
Anschlussstecker hinten



**D12335**  
droit - right - rechts



**D11868** **AMP 1.5-7P-F**



**D12336**  
gauche - left - links



**D12337**  
droit - right - rechts



## 725



E<sub>3</sub> 51788

Affectations constructeurs  
OE applications  
Fahrzeugverwendung

IVECO p. 51

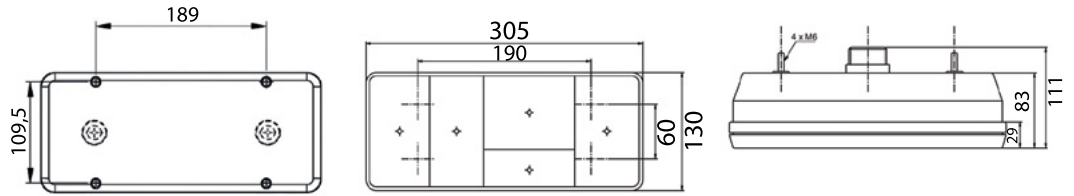

**725040**

gauche - left - links



IVECO  
arrière  
rear connector  
Anschlussstecker hinten



**725020**

gauche - left - links



IVECO  
arrière  
rear connector  
Anschlussstecker hinten



**725010**

droit - right - rechts



**726310**

gauche - left - links

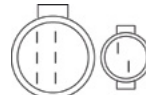

IVECO  
arrière  
rear connector  
Anschlussstecker hinten



**726320**

droit - right - rechts



**725002**

gauche - left - links



**725012**

droit - right - rechts



**725022**

gauche - left - links



**725032**

droit - right - rechts



# Feux arriere - Rear lamps - Heckleuchten

## 725



E<sub>3</sub> 51788

Affectations constructeurs  
OE applications  
Fahrzeugverwendung

IVECO p. 51

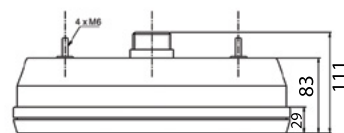
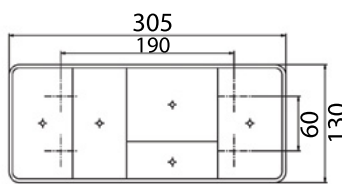
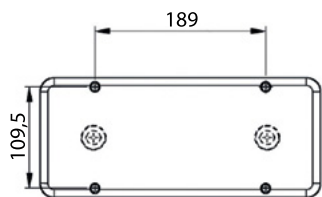

**726290**

gauche - left - links

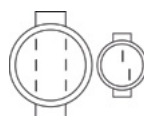

IVECO  
arrière  
rear connector  
Anschlussstecker hinten

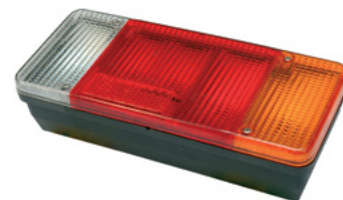

**726300**

droit - right - rechts



**726350**

gauche - left - links

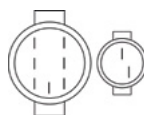

IVECO  
arrière  
rear connector  
Anschlussstecker hinten



**726450**

gauche - left - links



IVECO  
arrière  
rear connector  
Anschlussstecker hinten

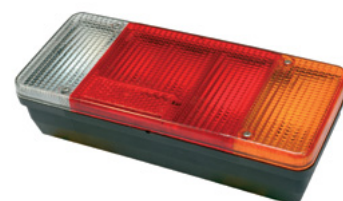

**726460**

droit - right - rechts



**725002**

gauche - left - links



**725012**

droit - right - rechts



**725022**

gauche - left - links



**725032**

droit - right - rechts



# Feux arriere - Rear lamps - Heckleuchten

## MILI



E<sub>2</sub> 88731 (5F)  
5108 (3F)  
253 (2F)

ROBUSTE ET ETANCHE  
ROBUST AND WATERPROOF  
ROBUST UND WASSERDICHT

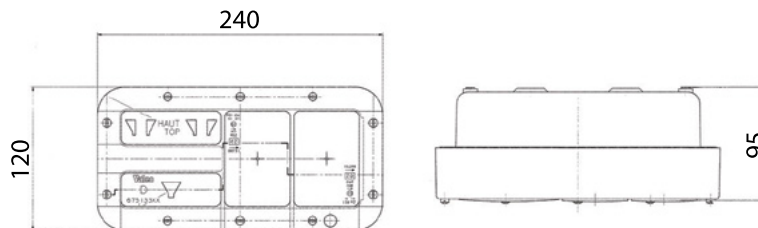

**67513371** gauche - left - links

**67513390**

cabochon - lens - Lichtscheibe



**67513361** droit - right - rechts

**67513380**

cabochon - lens - Lichtscheibe



**60760541**

position - clignotant - black out position  
position - indicator - black out position  
schlussleuchte - richtungsanzeiger - black out



**60760551**

brouillard - recul  
fog - reverse  
nebelschlussleuchte - rückfahrleuchte

## BBS 516



E<sub>1</sub> 1559  
53329

Affectations constructeurs  
OE applications  
Fahrzeugverwendung

MANITOU p. 73

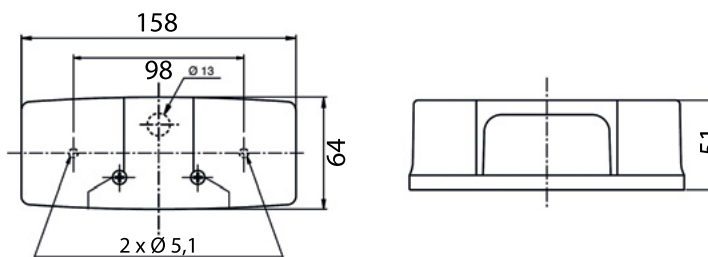

**500930**

gauche - left - links



PF  
arrière  
rear connector  
Anschlussstecker hinten



**500940**

droit - right - rechts





# Feux arriere - Rear lamps - Heckleuchten

## FRR



Ø 140 mm x 80 mm



9657 (3 fcts)  
697  
698



**D10841**

gauche/droit - left/right - links/rechts



PF  
arrière  
rear connector  
Anschlussstecker hinten



**D10840**

P21W

feu de recul  
reverse lamp  
rückfahrleuchte



**D10839**

P21W

feu de brouillard  
fog lamp  
nebelschlussleuchte

# Feux arriere - Rear lamps - Heckleuchten

## 2711



E<sub>3</sub> 38553

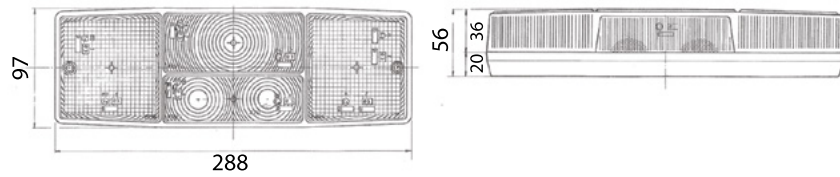

**D14523**  
(27.11.090.VLG)

**D14525**  
(27.11.991.VLG)  
gauche - left - links



PE  
arrière  
rear connector  
Anschlusstecker hinten



**D14524**  
(27.11.092.VLG)

**D14526**  
(27.11.992.VLG)  
droit - right - rechts



## 2704



E<sub>3</sub> 2887

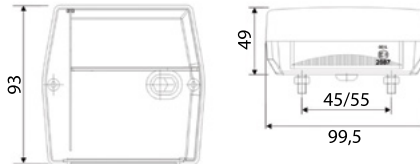

**D14518**  
(27.04.042.VLS)  
gauche/droit - left/right - links/rechts



PF  
arrière  
rear connector  
Anschlusstecker hinten



**D14527**  
(27.04.V66.MV7) 7,5 m  
valisette 2 feux câblés magnétiques  
2 wired lamps magnetic in case  
Koffer 2 magnetische Kabel Lichter

# Eclaireur de plaque Number plate lamps Kennzeichenleuchten

WWW.VIGNAL-GROUP.COM

## LED p. 179-180

**NEW**



## Halogene p. 181



SS-2P-F

Type connecteur - Nb pins - Mâle ou Femelle  
Connector type - Pins Nb - Male or Female  
Steckertyp - Stifte Nb - männlich oder weiblich



Faisceau p. 307  
Harness p. 307  
Anschlusskabel siehe S. p. 307



Flashez le QR code pour plus d'infos  
Scan the QR code for more info  
Scannen Sie den QR-Code für weitere Informationen



Pièces détachées  
Spare parts  
Ersatzteile



Numéro d'homologation  
Approval number  
Zulassungsnummer



Sens de montage  
Mounting direction  
Einbaurichtung

# Eclaireurs de plaque - Number plate lamps - Kennzeichenleuchten

## LPL18

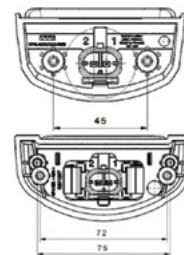
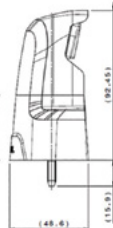
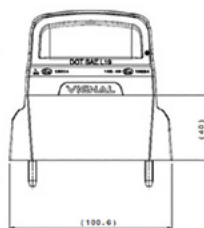
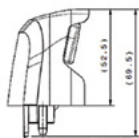
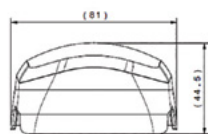

LED

12/24V

ADR



E2 19014  
10R-19224

SAE

IP6K9K

**NEW**



**199020**

SS-2P-M

Entraxe 72 mm  
Bolt distance 72 mm  
Befestigungsmittelpunkt 72 mm



**199030**

SS-2P-M

Entraxe 75 mm  
Bolt distance 75 mm  
Befestigungsmittelpunkt 75 mm

1 seul feu LED par plaque  
1 LED lamp per plate  
1 LED-Licht pro Platte



199020  
199030

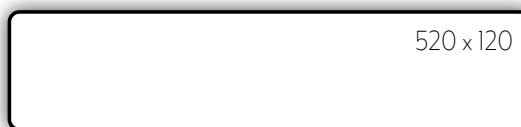

**NEW**



**199000**

SS-2P-M

clippé - clipped - clip-befestigung



**199040**

SS-2P-M

Entraxe 45 mm  
Bolt distance 45 mm  
Befestigungsmittelpunkt 45 mm

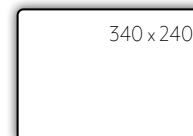
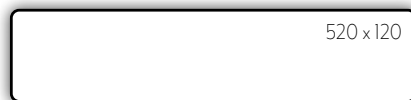
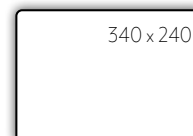
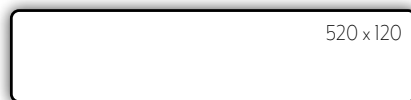

Affectations constructeurs  
OE applications  
Fahrzeugverwendung

CASE p. 16  
IVECO p. 51  
LAMBERET p. 62  
NEW HOLLAND p. 80

Plus d'implantations sur  
notre site web.  
More positioning on our  
website.  
Mehr Positionierung auf  
unserer Website.



**D13880**

SS-2P-F

SS-2P-F

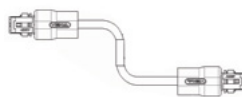

**D14985**

SS-2P-F



# Eclaireurs de plaque - Number plate lamps - Kennzeichenleuchten

## EPP96 LED

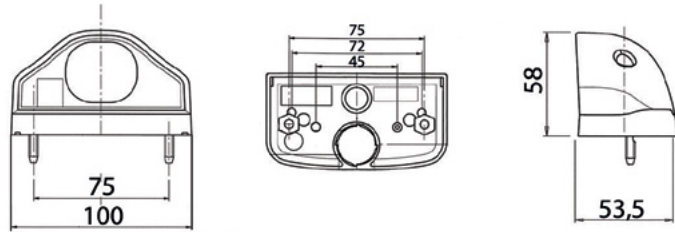

LED

24V

ADR



E<sub>2</sub> 11017

Affectations constructeurs  
OE applications  
Fahrzeugverwendung

- ASCA p. 8
- BENALU p. 12
- DE BUF p. 28
- FRUEHAUF p. 35
- GUILLEN p. 37
- LAMBERET p. 61
- OMEPS p. 82
- SOR IBERICA p. 119



**D13609** 400 mm

**D13610** 1500 mm



**R14364** 2000 mm

2V Superseal  
Pour / For / Für LC12T



**D13874** 2000 mm

2 voies - 2 poles - 2 polig  
Pour / For / Für LC8

## BX868

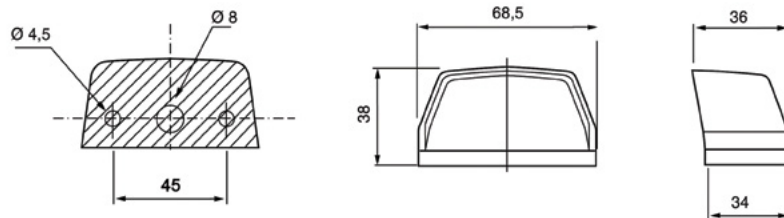

LED

12/24V

E<sub>13</sub> 10989



**D14116** 300 mm

# Eclaireurs de plaque - Number plate lamps - Kennzeichenleuchten

## EPP96/98



R10W



12/24V

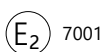

Affectations constructeurs  
OE applications  
Fahrzeugverwendung

- ASCA p. 8
- CHEREAU p. 21
- CLAAS p. 22
- FRUEHAUF p. 36
- GUILLEN p. 37
- LAMBERET p. 63
- MERCEDES p. 78
- RENAULT TRUCKS p. 101
- SOR IBERICA p. 120
- UD TRUCKS p. 124
- VOLVO TRUCKS p. 128

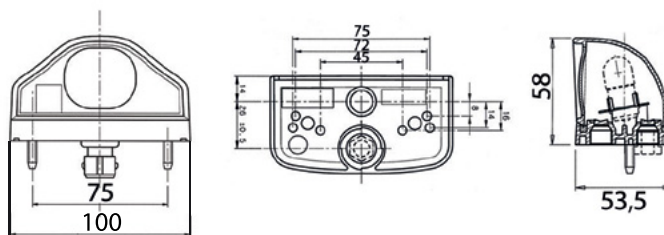

**196020**



**000176**

Affectations constructeurs  
OE applications  
Fahrzeugverwendung

- BOBCAT p. 15
- DAF p. 26
- OPEL p. 84
- RENAULT TRUCKS p. 101
- UD TRUCKS p. 124
- VOLVO TRUCKS p. 134



CLICK-IN

**D10502**

410 mm



HDSCS-3P-M

**196170**

500 mm



POS-2P-F

**D10227**

700 mm

2 voies - 2 poles - 2 polig  
Pour / For / Für LC8



Affectations constructeurs  
OE applications  
Fahrzeugverwendung

- BOBCAT p. 15
- DAF p. 26
- OPEL p. 84
- RENAULT TRUCKS p. 101
- UD TRUCKS p. 124
- VOLVO TRUCKS p. 134



**196010**

JPT-2P-M



**D13876**

JPT-2P-F



**280009**

JPT-2P-F

2 m

## 2751



C5W



12/24V

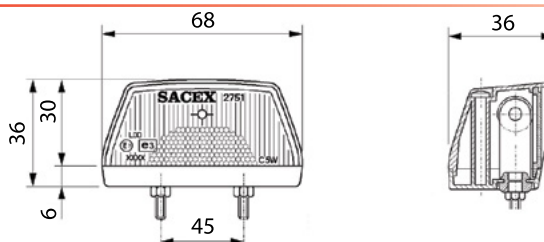
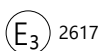

**D14517**

(27.51.090.VLG)

# Feux clignotants

## Flasher lamps

### Fahrtrichtungsanzeiger

**Face avant - Front face - Frontansicht**  
p. 183-184

**Face latérale - Side face - Seitenansicht**  
p. 185-188

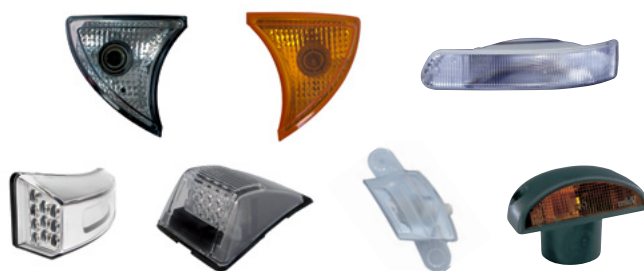

**JPT-2P-F**

Type connecteur - Nb pins - Mâle ou Femelle  
Connector type - Pins Nb - Male or Female  
Steckertyp - Stifte Nb - männlich oder weiblich



Flashez le QR code pour plus d'infos  
Scan the QR code for more info  
Scannen Sie den QR-Code für weitere Informationen



Pièces détachées  
Spare parts  
Ersatzteile



Numéro d'homologation  
Approval number  
Zulassungsnummer

## C105

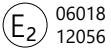

Affectations constructeurs  
OE applications  
Fahrzeugverwendung

[IVECO p.47](#)



**110520**

gauche - left - links



**110530**

droit - right - rechts



**110550**

gauche - left - links



**110560**

droit - right - rechts



**001619**

## C199

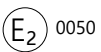

Affectations constructeurs  
OE applications  
Fahrzeugverwendung

[IVECO p.47](#)



**119920**

gauche - left - links



**119930**

droit - right - rechts



## FLASHER UNIT



### 014580

Renault 5010149149  
5 lampes, centrale clignotante  
5 lamps, flasher unit  
5 Glühlampen, Blinkereinheit

## SRD08



LED

⚡ 24V

E<sub>2</sub> 10073

Affectations constructeurs  
OE applications  
Fahrzeugverwendung

[VOLVO TRUCKS p. 127](#)



**111000**

gauche - left - links



**111010**

droit - right - rechts



**111020**

gauche - left - links



**111030**

droit - right - rechts

## SRD07



LED

⚡ 24V

E<sub>2</sub> 08028

Affectations constructeurs  
OE applications  
Fahrzeugverwendung

[VOLVO TRUCKS p. 128](#)



**107000**

gauche - left - links



**107010**

droit - right - rechts



**107040**

gauche - left - links



**107050**

droit - right - rechts



**107500**

gauche - left - links



**107510**

droit - right - rechts

# Feux clignotants - Flasher lamps - Fahrtrichtungsanzeiger

## ICDL15



P21W



16059



**120000**

Affectations constructeurs  
OE applications  
Fahrzeugverwendung

[UD TRUCKS p. 124](#)

## ICDL10



PY21W



11128



**117000**

gauche - left - links



**117010**

droit - right - rechts

Affectations constructeurs  
OE applications  
Fahrzeugverwendung

[DAF p. 25](#)



**001619**

## ICDL07



PY21W



09025



**109010**

Affectations constructeurs  
OE applications  
Fahrzeugverwendung

[DAF p. 24](#)



## ICDL94



E2 5047 (R5W)  
7139 (P21W)

Affectations constructeurs  
OE applications  
Fahrzeugverwendung

DAF p. 26  
IVECO p. 52  
IVECO BUS p. 55  
NISSAN p. 81  
RENAULT TRUCKS p. 97  
VOLVO TRUCKS p. 133

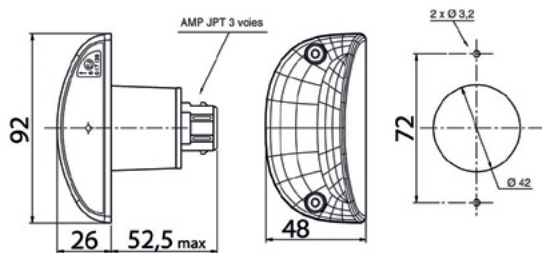

R5W

**119450**



**119550**



P21W

**119470**



**D13877**

JPT-2P-F



**001616**

JPT-2P-M

## FE85



E2 86708  
9033

Affectations constructeurs  
OE applications  
Fahrzeugverwendung

RENAULT TRUCKS p. 92

R5W



**185040**

P21W



**185160**

# Feux clignotants - Flasher lamps - Fahrtrichtungsanzeiger

## FE87



C5W



4703

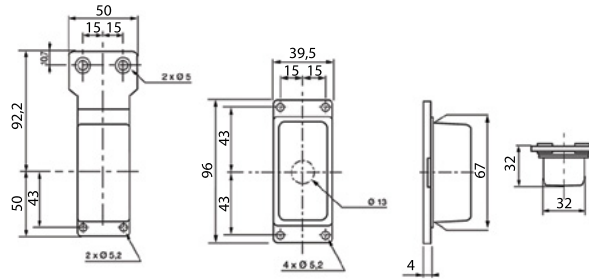

**187140**



**187760**



**087040**

cabochon - lens - Lichtscheibe

## FE81



T4W



90711

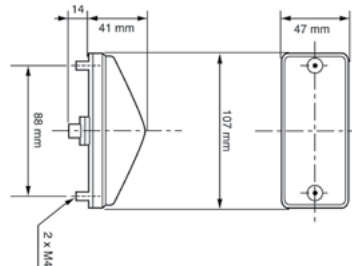

**181050**

**181070**

version pétrolière  
petroleum version  
für Tankfahrzeuge



**000086**

# Feux de position

## Position lamps

## Positionsleuchten



### Face avant - Front face - Frontansicht

p. 190-195



### Face latérale - Side face - Seitenansicht

p. 196-201



### Face arrière - Rear face - Heckansicht

p. 202-205



K

Catadioptr  
Reflector  
Rückstrahler



Flashez le QR code pour plus d'infos  
Scan the QR code for more info  
Scannen Sie den QR-Code für weitere Informationen



Pièces détachées  
Spare parts  
Ersatzteile

E<sub>2</sub>

Numéro d'homologation  
Approval number  
Zulassungsnummer



Sens de montage  
Mounting direction  
Einbaurichtung

DT-2P-M

Type connecteur - Nb pins - Mâle ou Femelle  
Connector type - Pins Nb - Male or Female  
Steckertyp - Stifte Nb - männlich oder weiblich



Faisceau p. 307  
Harness p. 307  
Anschlusskabel siehe S. 307

# Feux de position - Position lamps - Positionsleuchten

## FE04



LED

24V

ADR



E2 05010 SAE P2

Affectations constructeurs  
OE applications  
Fahrzeugverwendung

ASCA p. 10  
LAMBERET p. 63  
RENAULT TRUCKS p. 92



p. 202

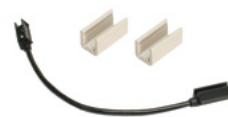
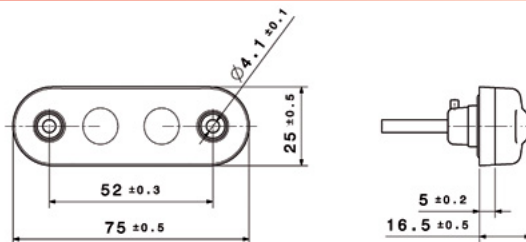

<b>104290</b>	500 mm
<b>104300</b>	1500 mm
<b>104310</b>	5000 mm

<b>D10132</b>	200 mm
---------------	--------

CLICK-IN



<b>104570</b>	300 mm
---------------	--------

DT-2P-M



<b>104450</b>	300 mm
---------------	--------

DT-2P-M



<b>D14170</b>	
---------------	--

DT-2P-F



<b>104510</b>	300 mm
---------------	--------

CLICK-IN

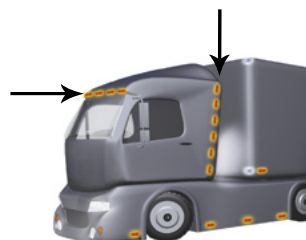

<b>D11268</b>	16 m
---------------	------

câble plat - flat cable - flachkabel

# Feux de position - Position lamps - Positionsleuchten

## SMD04

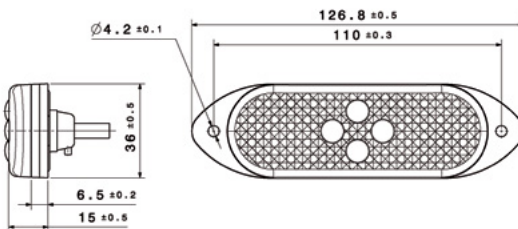

LED

24V

ADR



E<sub>2</sub> 05022

p. 196

p. 202



**104130** 500 mm **K**

**104140** 1500 mm **K**

**104520** 1000 mm **K**

**104690** 1000 mm **K**

CLICK-IN

adhésif - adhesive - selbstklebend

CLICK-IN

SS-2P-M

**NEW**

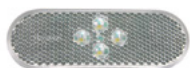

**104720** **K**

SS-2P-M

## SMD98

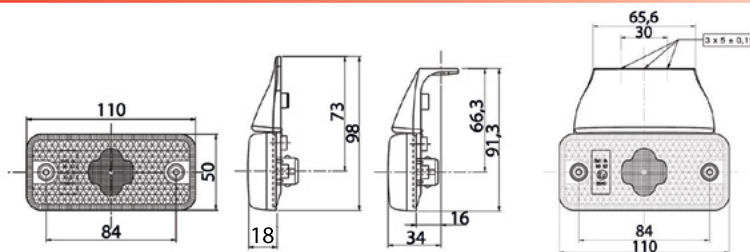

LED

12V  
ou-or-oder  
24V

ADR



E<sub>2</sub> 04010

p. 197

p. 203



**198690** 12V **K**

**D10500** 500 mm **K**

**D13710** 1000 mm **K**

**198660** 24V **K**

**D11399** 1500 mm **K**

**D13710** 1000 mm **K**

JPT-2P-M

CLICK-IN

POS-2P-F

2 voies - 2 poles - 2 polig  
Pour / For / Für LC8



**D13876** JPT-2P-F



**001696**



**001716**



# Feux de position - Position lamps - Positionsleuchten

## FE94/98



T4W



12/24V



E<sub>2</sub> 4088  
4089 (K)

p. 198

p. 203

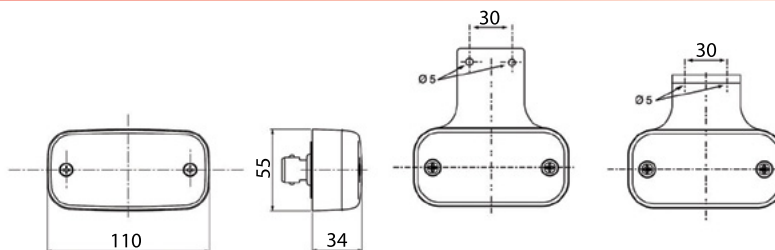

**198040**



JPT-2P-M



**198050**



**194190**



PE



**194130**



**194140**



**194150**



**D13876**

JPT-2P-F



**000176**



**094046**



**094036**



**001596**



**001586**

# Feux de position - Position lamps - Positionsleuchten

## FE02

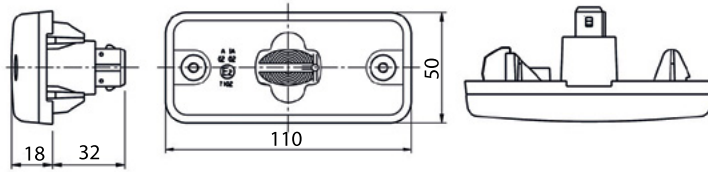

**102200**

K

clippé - clipped - clip-befestigung

**D13876**

JPT-2P-F

**001726**

## FPL93

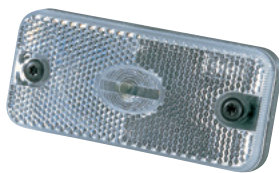
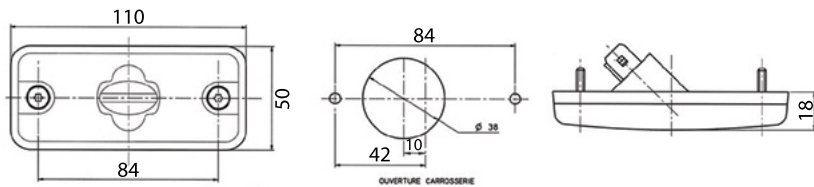

**193200**

K

vissé - screwed - geschraubt

**D13876**

JPT-2P-F

**001726**



## FE95



140 mm x 65 mm x 30,5 mm



**195010**

semelle plate - flat gasket - flache Sockeldichtung

**195030**

semelle galbée - curved gasket - gewölbte Sockeldichtung

Affectations constructeurs  
OE applications  
Fahrzeugverwendung

DAF p. 26  
HEULIEZ p. 39  
IVECO BUS p. 54  
RENAULT TRUCKS p. 96  
VOLVO TRUCKS p. 133

# Feux de position - Position lamps - Positionsleuchten

## FE85



175 mm x 68 mm x 52 mm



R5W



24V



9037



**185010**

semelle galbée - curved gasket - gewölbte Sockeldichtung



**185020**

semelle plate - flat gasket - flache Sockeldichtung

Affectations constructeurs  
OE applications  
Fahrzeugverwendung

HEULIEZ p. 39

IVECO BUS p. 57

RENAULT TRUCKS p. 92

## FE87

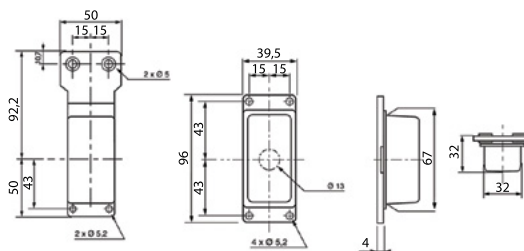

C5W



12/24V



86710



**187120**



**187720**



**087020**

cabochon - lens - Lichtscheibe

## PLR272



C5W



12/24V

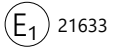

21633

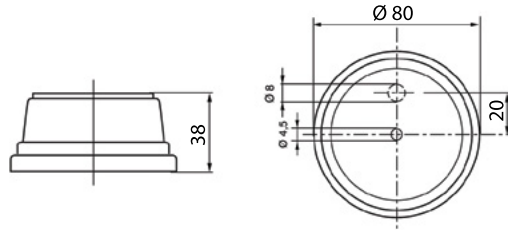

**521010**



**521050**



cabochon - lens - Lichtscheibe

## FG80



R5W



12/24V

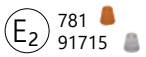

781  
91715

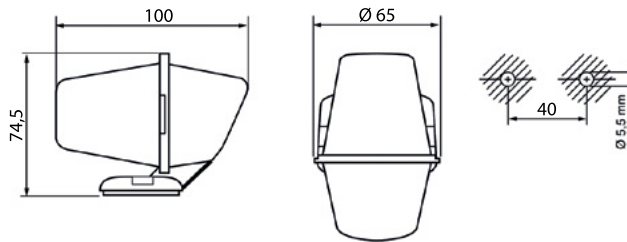

**180010**



**080026**



**180040**

R5W



**080046**

# Feux de position - Position lamps - Positionsleuchten

## SMD04

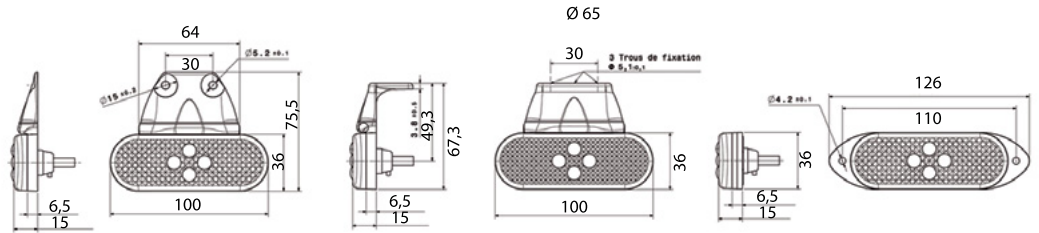

LED

24V

ADR



E<sub>2</sub> 05021

p. 191

p. 202



<b>104090</b>	500 mm	K	<b>104210</b>	500 mm	K	<b>104250</b>	500 mm	K
<b>104100</b>	1500 mm	K	<b>104220</b>	1500 mm	K	<b>104260</b>	1500 mm	K
CLICK-IN			CLICK-IN			CLICK-IN		



<b>104640</b>	300 mm	K	<b>D12699</b>	1000 mm	K
<b>104650</b>	1000 mm	K			
bride rallongée - extended bracket - Montagewinkel verlängerter			CLICK-IN		



<b>104670</b>		K	<b>104700</b>	LED-24V	K
SS-2P-M			SS-2P-M		



**D13880** SS-2P-F

## SMCU



FEUX DE POSITION LATÉRAUX LED CLIGNOTANTS gestion selon supplément 6 - R48  
LED SIDE MARKER FLASHING LAMPS management supp 6 - R48  
LED SEITLICHEN BLINKLEUCHTENT Ansteuerung gemäß der Erweiterung 6 - R48

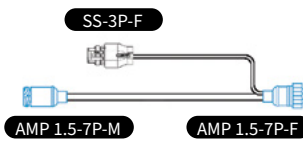

**D14362** SS-3P-F



**D13880** SS-2P-F

12/24V

**D14722**  
LED Side marker control unit

**D14879**

# Feux de position - Position lamps - Positionsleuchten

## SMD98



LED

12V  
ou-or-oder  
24V

ADR

4xLED

2xLED

E<sub>2</sub> 8040

p. 191

p. 203

Affectations constructeurs  
OE applications  
Fahrzeugverwendung

- CASE p. 16
- FELDBINDER p. 33
- IVECO p. 45
- IVECO BUS p. 54
- LAMBERET p. 64
- LECINENA p. 67
- MERCEDES p. 78
- MANITOWOC p. 75
- NEW HOLLAND p. 80
- RENAULT TRUCKS p. 97
- VOLVO BUS p. 135
- VOLVO CONSTRUCTION p. 136

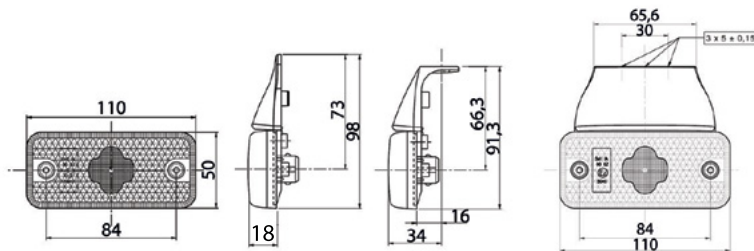

**198510** 4 x LED-12V K



**198650** 2 x LED-24V K



**198810** 4 x LED-12V K

**198520** 4 x LED-24V K

JPT-2P-M

**198760** 4 x LED-24V K

SS-2P-M



**198580** 4 x LED-12V K



**198530** 2 x LED-24V K

JPT-2P-M



**D13713** 1000 mm K

POS-2P-F

2 x LED-24V

2 voies - 2 poles - 2 polig  
Pour / For / Für LC8

K



**D10493** 500 mm K

4 x LED-24V



**D10494** 500 mm K

2 x LED-24V



**D10495** 500 mm K

2 x LED-24V

**D10496** 1500 mm K

CLICK-IN

**D10497** 1500 mm K

CLICK-IN

**D10498** 1500 mm K

CLICK-IN



**D12867** 2 x LED-24V K

CLICK-IN



**D13876** K

JPT-2P-F



**D13880** K

SS-2P-F



**001696**



**001716**

# Feux de position - Position lamps - Positionsleuchten

## SMD00

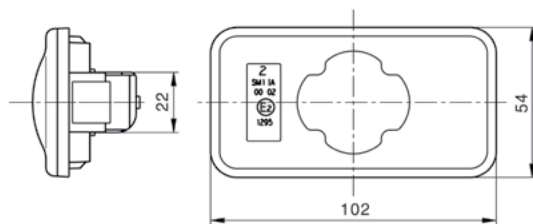

LED

24V

ADR



E<sub>2</sub> 1295

Affectations constructeurs  
OE applications  
Fahrzeugverwendung

RENAULT TRUCKS p. 88  
VOLVO TRUCKS p. 130

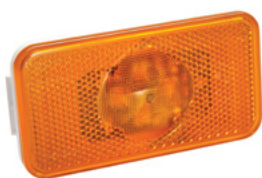

**198620**

K

Cuve blanche - cabochon PMMA  
White body - PMMA lens  
Weißes Gehäuse - PMMA Lichtscheibe

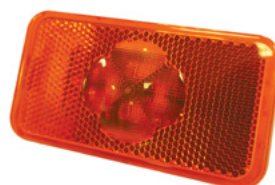

**198740**

K

Cuve ambre - cabochon PC résistant haute température et chocs  
Amber body - high temperature and impact resistant PC lens  
Oranges Gehäuse - Hochtemperatur- und schlagfestes PC Lichtscheibe



**001766** 600 mm

adaptateur - adaptator - Adapterkabel

## FE94/98

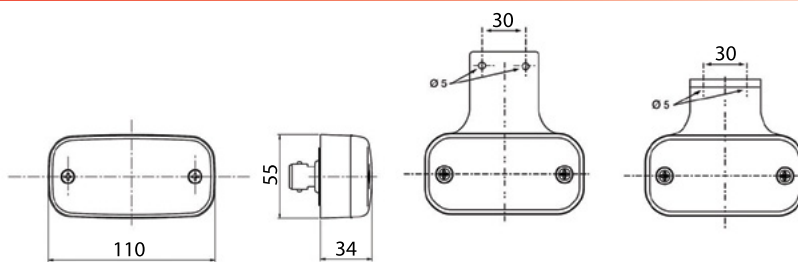

T4W

12/24V

ADR



E<sub>2</sub> 4092  
4093 (K)

p. 192

p. 204



**198010**

K



JPT-2P-M



**198020**

K



**198030**

K



**D13876**

JPT-2P-F

## FE94/98

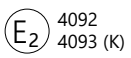

194070



PE



194010



194080



194020



194090



194030



D13876

JPT-2P-F



000176



094026



094016



001596



001586



001696



001716



# Feux de position - Position lamps - Positionsleuchten

## FPL93

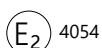
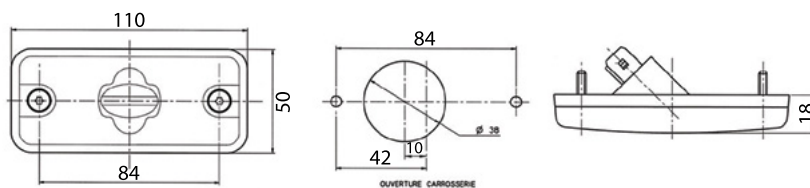

Affectations constructeurs  
OE applications  
Fahrzeugverwendung

- DAF p. 25
- FIAT p. 34
- HEULIEZ p. 40
- IVECO p. 45
- IVECO BUS p. 57
- RENAULT TRUCKSp. 92
- VOLVO TRUCKS p. 134



**193020**



JPT-2P-M



**193280**



JPT-2P-M



**193170**



SS-2P-M



**193360**



SS-2P-M



**193290**

380 mm



SS-2P-M



**D13876**

JPT-2P-F



**D13880**

SS-2P-F



**001726**

JPT-2P-M



**001916**

SS-2P-M



**001696**



**001716**

## 672



W3W



12/24V

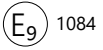

1084

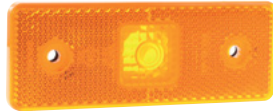
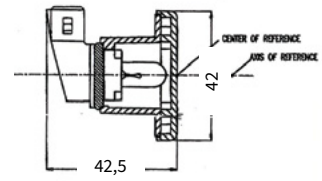
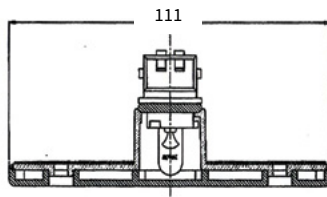

**672410** 200 mm

## FE87



C5W



12/24V

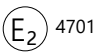

4701

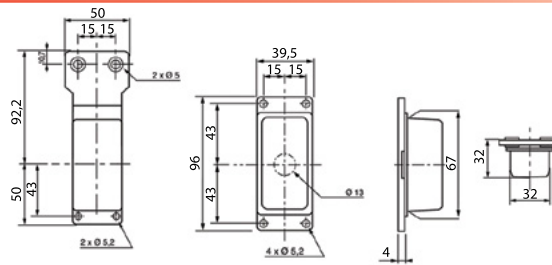

**187140**



**187760**



**087040**

cabochon - lens - Lichtscheibe

# Feux de position - Position lamps - Positionsleuchten

## FE04

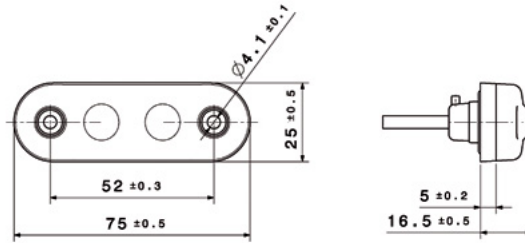

LED

24V

ADR



E<sub>2</sub> 05011

p. 190



<b>104330</b>	500 mm
<b>104340</b>	1500 mm
<b>104360</b>	5000 mm

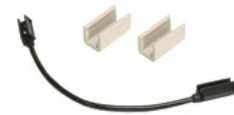

**D10132** 200 mm

CLICK-IN

## SMD04

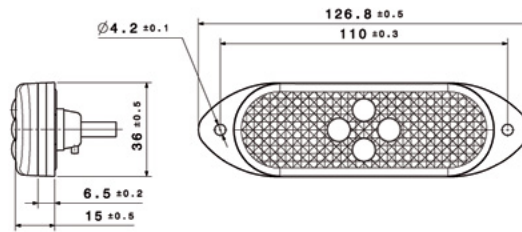

LED

24V

ADR



E<sub>2</sub> 05023

p. 191

p. 196



**NEW**



<b>104170</b>	500 mm	<b>K</b>
<b>104180</b>	1500 mm	<b>K</b>

CLICK-IN

<b>104680</b>	<b>K</b>	<b>104710</b>	<b>K</b>
---------------	----------	---------------	----------

SS-2P-M

SS-2P-M



**D13880** SS-2P-F

# Feux de position - Position lamps - Positionsleuchten

## SMD98



LED

24V

ADR

H

E<sub>2</sub> 2065

p. 191

p. 197

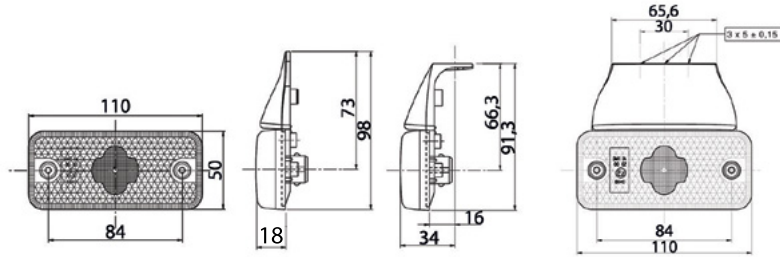

198640

D11400 1500 mm

D10499 3500 mm

K

K

K

JPT-2P-M

CLICK-IN

D13876

JPT-2P-F

001696

001716



## FE94/98



T4W

12/24V

ADR

H V

E<sub>2</sub> 4090  
4091 (K)

p. 192

p. 199

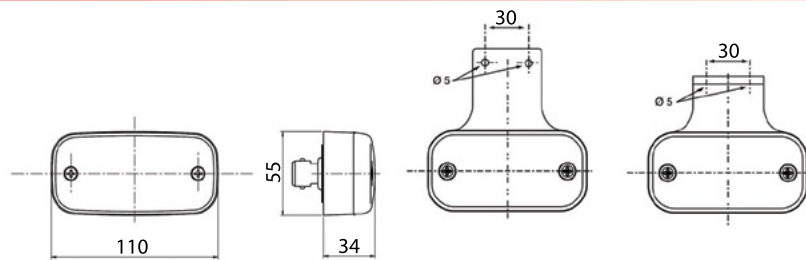

198060

# Feux de position - Position lamps - Positionsleuchten

## FE94/98



T4W



12/24V



E<sub>2</sub> 4090  
4091 (K)

p. 192

p. 199

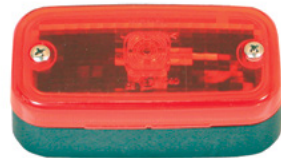
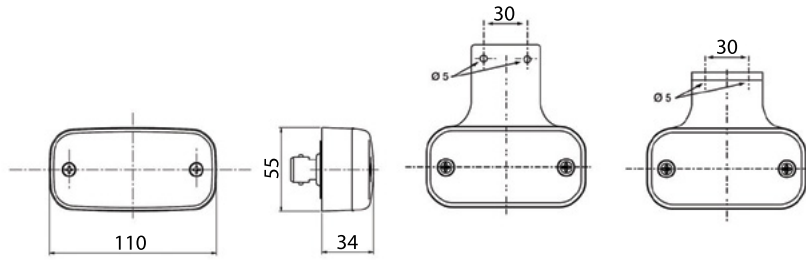

**194310**



PE



**194250**

**K**



**194260**

**K**



**194270**

**K**



**D13876**

**JPT-2P-F**



**000176**



**094066**



**094056**

**K**



**001596**



**001586**

## FE87

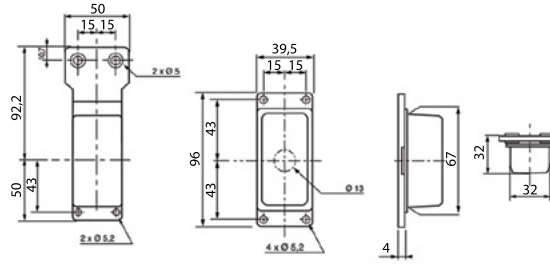
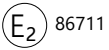

**187130**



**187730**



**087030**

cabochon - lens - Lichtscheibe

## FE95

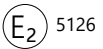

Affectations constructeurs  
OE applications  
Fahrzeugverwendung

HEULIEZ p. 39  
IVECO BUS p. 54

140 mm x 65 mm x 30,5 mm



**195060**

## FE85

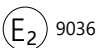

175 mm x 68 mm x 52 mm



**185030**

semelle galbée - curved gasket - gewölbte Sockeldichtung



**185050**

semelle plate - flat gasket - flache Sockeldichtung

# Feux de gabarits

## End outline marker lamps

### Begrenzungsleuchten



### Tricolore - Tricolour - Dreifarbig

p. 207-209



### Bicolore - Bicolor - Zweifarbig

p. 210-212



SS-2P-F

Type connecteur - Nb pins - Mâle ou Femelle  
Connector type - Pins Nb - Male or Female  
Steckertyp - Stifte Nb - männlich oder weiblich



Flashez le QR code pour plus d'infos  
Scan the QR code for more info  
Scannen Sie den QR-Code für weitere Informationen



Pièces détachées  
Spare parts  
Ersatzteile



Numéro d'homologation  
Approval number  
Zulassungsnummer

# Feux de gabarits - End outline marker lamps - Begrenzungsleuchten

## FA3 LED



LED

12/24V

ADR

E<sub>2</sub> 14010

\* fils nus - naked cable extre-  
mity - Kabellitze

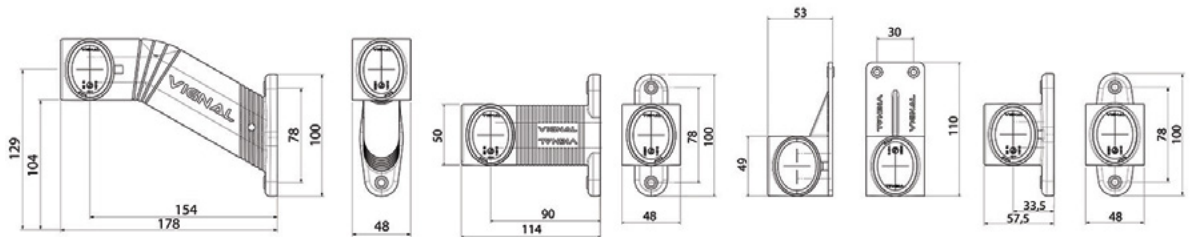

**D14421\*** 1700 mm

**D14427** 1500 mm

gauche - left - links

CLICK-IN



**D14422\*** 1700 mm

**D14428** 1500 mm

droit - right - rechts

CLICK-IN



**D14423** 1500 mm

gauche - left - links

POS-2P-F



Pour / For / Für LC8  
D14423 - D14424 - D13875



**D14424** 1500 mm

droit - right - rechts

POS-2P-F



**D14425** 1500 mm

gauche - left - links

SS-2P-F



Pour / For / Für LC12T  
D14425 - D14426 - D14655



**D14426** 1500 mm

droit - right - rechts

SS-2P-F



**D14431\*** 1700 mm

**D14429** 1500 mm

gauche - left - links

CLICK-IN



**D14432\*** 1700 mm

**D14430** 1500 mm

droit - right - rechts

CLICK-IN



**D14031\*** 1700 mm

**D14035** 1500 mm

**D14655** 1500 mm

symétrique - symmetrical - symmetrisch

CLICK-IN

SS-2P-F



**D14030\*** 1700 mm

**D14034** 1500 mm

**D13875** 1500 mm

symétrique - symmetrical - symmetrisch

CLICK-IN

POS-2P-F



## FA3 LC12 LED



LED

12/24V

ADR

E<sub>2</sub> 14010



**NEW**



**D14781** 350 mm  
gauche - left - links **SS-2P-F**



**D14782** 350 mm  
droit - right - rechts **SS-2P-F**

## FA3 LED LC8



LED

12/24V

ADR

E<sub>2</sub> 14010



**D14038** 500 mm  
gauche - left - links **CLICK-IN**



**D14037** 500 mm  
droit - right - rechts **CLICK-IN**



**D14039** 350 mm  
gauche - left - links **POS-2P-F**



**D14040** 350 mm  
droit - right - rechts **POS-2P-F**

# Feux de gabarits - End outline marker lamps - Begrenzungsleuchten

## DX LC8



W5W



24V



ADR

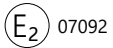

07092



**D13034** 500 mm  
gauche - left - links **CLICK-IN**



**D13035** 500 mm  
droit - right - rechts **CLICK-IN**



**D12712** 350 mm  
gauche - left - links **POS-2P-F**



**D12711** 350 mm  
droit - right - rechts **POS-2P-F**

## DX



W5W



24V



ADR

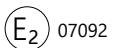

07092



**D12430**



**D12429**

1500 mm

**CLICK-IN**



**D12428**

1400 mm

**CLICK-IN**



**D12471**



**D12473**

**K**



**D12472**

1500 mm

Lampe non fournie - bulb  
not included - nichte inklusiv  
glühlampen

# Feux de gabarits - End outline marker lamps - Begrenzungsleuchten

## DX LED



90 mm x 50 mm x 180 mm

LED

12/24V

E<sub>20</sub> 020889  
020890



**D13624**

filis nus - naked cable extremity - Kabellitze

## DX



W5W

12/24V

ADR

E<sub>2</sub> 10035



\* filis nus - naked cable extremity - Kabellitze

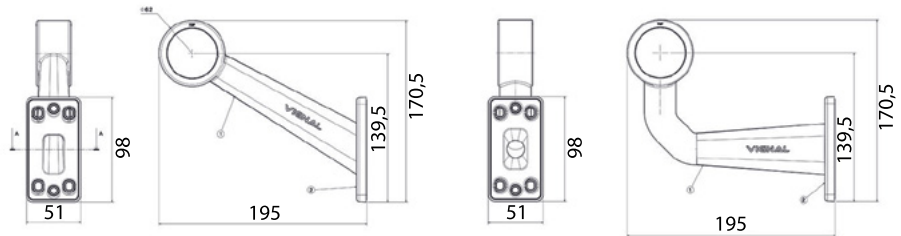

**D10642 \***



**D10643 \***



**D10503**

600 mm

CLICK-IN



**D10800**



R5W - 12/24V



**D11899**

500 mm

2 voies - 2 poles - 2 polig  
Pour / For / Für LC8



POS-2P-F



**611010**



**611020**



**D13277** 350 mm



**D11147** 500 mm



**610080** R5W

Lampe non fournie - bulb  
not included - nichte inklusiv  
glühlampen

# Feux de gabarits - End outline marker lamps - Begrenzungsleuchten

## FE12



LED

12/24V

E<sub>24</sub> 020078



\* fils nus - naked cable extremity - Kabellitze

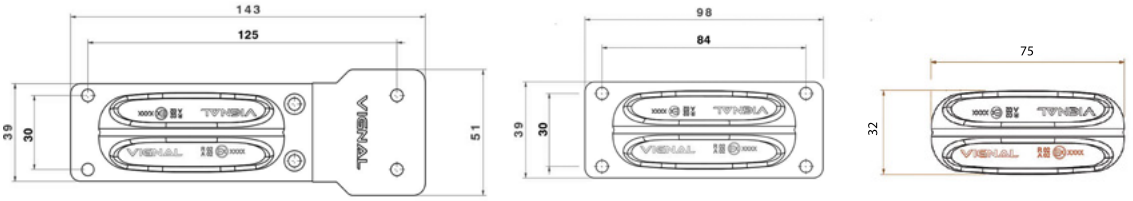

**112110** \* 1000 mm

**112130** 1500 mm **CLICK-IN**



**112710** \* 1000 mm

**112720** 1500 mm **CLICK-IN**



**112120** \* 1000 mm

**112140** 1500 mm **CLICK-IN**

## FE88



C5W

12/24V

E<sub>2</sub> 88714

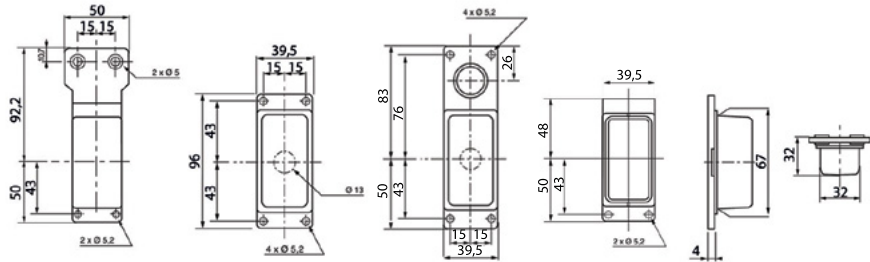

**188110**



**188210**

pour presse-étoupe 000176  
for o-ring 000176  
für PG-Verschraubung 000176



**188010**



**188710**



**188610**



**188310**



**088010**

cabochon - lens - Lichtscheibe



**000176**

## FE81



107 mm x 47 mm x 41 mm



T4W



12/24V



**181000**



**000086**

# Signalisation passive

## Warning products

## Warnmarkierungen



**Plaques réfléchissantes - Reflective plates - Rückstrahlende Tafeln**  
p. 214



**Bandes réfléchissantes - Reflective tapes - Reflektierende Streifen**  
p. 215



**Catadioptres - Reflectors - Rückstrahler**  
p. 216

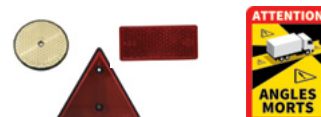

**Triangle de présignalisation - Warning triangle - Warndreiecke**  
p. 217



Flashez le QR code pour plus d'infos  
Scan the QR code for more info  
Scannen Sie den QR-Code für weitere Informationen



Pièces détachées  
Spare parts  
Ersatzteile



Numéro d'homologation  
Approval number  
Zulassungsnummer

# Plaques réfléchissantes - Reflective plates - Rückstrahlende Tafeln

## R70



### Camions / Cars et bus - Trucks / Coaches - LKW / Busse

1 x (130 x 1130)

2 x (130 x 565)

4 x (130 x 282)

E<sub>11</sub> 010002



\* adhésif - adhesive - Selbstklebend



**D14710** Alu 1 mm

**D14706** Adhésif \*

**D14711** Alu 1 mm

**D14707** Alu 1 mm

**D14535** Plastique

### Remorques - Trailers - Anhänger

1 x (195 x 1130)

2 x (195 x 565)

4 x (195 x 283)



**D14712** Alu 1 mm

**D14708** Adhésif \*

**D14713** Alu 1 mm

**D14709** Alu 1 mm

**D14536** Plastique

## VC69



E R69

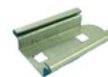
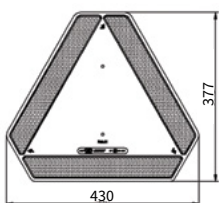

**D14532**

Véhicules lents - Slow vehicles - Langsame Fahrzeuge

**D14533**

**D14534**

# Bandes réfléchissantes - Reflective tapes - Reflektierende Streifen

## R104



50 m x 50,8 mm

Surface rigide - Rigid support - Auf Festaufbauten

E13 0001



**D12713**



**D12715**



**D12714**

E13 0002

Surface souple - Curtain support - Für Plane



**D13206**



**D13205**



**D13207**

Carrés pré-espacés - segmented squares - vorgeschrittene Quadrate

## BA



2 x 9 m x 141 mm



**D14714** Cl. A: >80m

**D14716** Cl. B: >500m

Classe 1 : ville et route nationale - town and trunk roads - Stadt und Landstrassen  
Classe 2 : autoroutes et voies rapides - highways - Autobahnen und Schnellstrassen

2 x 45 m x 141 mm



**D14715** Cl. A: >80m



# Catadioptres - Reflectors - Rückstrahler

CA



Plastique - Plastic housing - Kunststoffgehäuse

Ø 61 mm

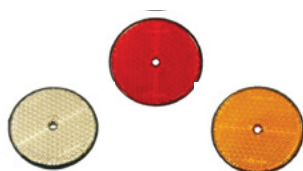

- D14592 ●
- D14591 ○
- D14593 ●

Ø 85 mm

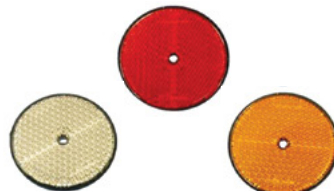

- D14589 ●
- D14588 ○
- D14590 ●

57 mm x 39 mm



- D14595 ●
- D14594 ○
- D14596 ●

105 mm x 45 mm



- 240366 ●
- 240346 ○
- 240356 ●

adhésif - adhesive - Selbstklebend

105 mm x 45 mm - M4



- 241366 ●
- 241346 ○
- 241356 ●

90 mm x 39 mm



- 624036 ●
- 624016 ○
- 624026 ●

adhésif - adhesive - Selbstklebend

159 mm x 159 mm x 159 mm



D14587

DSR



250 mm x 170 mm

**NEW**



D14990  
Camions et poids lourds

250 mm x 170 mm



D14991  
Cars et bus

# Triangle de présignalisation - Warning triangle - Warndreiecke

## TRI



Affectations constructeurs  
OE applications  
Fahrzeugverwendung

RENAULT TRUCKS p. 86

SCANIA p. 116

VOLVO CONSTRUCTION p. 136

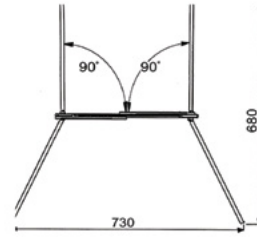
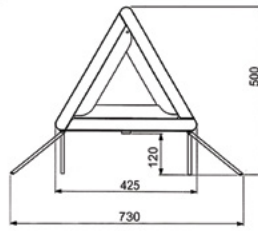

**D10596**  
(564.VTO.VLG)

# Phares homologués recul

Reverse approved work lights

Rückfahrlicht Zulassung Arbeitsscheinwerfer



DT-2P-M

Type connecteur - Nb pins - Mâle ou Femelle  
Connector type - Pins Nb - Male or Female  
Steckertyp - Stifte Nb - männlich oder weiblich



Flashez le QR code pour plus d'infos  
Scan the QR code for more info  
Scannen Sie den QR-Code für weitere Informationen



Pièces détachées  
Spare parts  
Ersatzteile



Numéro d'homologation  
Approval number  
Zulassungsnummer



Homologué ECE-R23  
ECE-R23 Approved  
Zulassen ECE-R23



Faisceau p. 301  
Harness p. 301  
Anschlusskabel siehe S. p. 301



Vitre en verre trempé  
Tempered glass lens  
Lichtsceibe aus gehärtetem Glas



Vitre en polycarbonate  
Polycarbonate lens  
Lichtsceibe aus Polycarbonat

## SL 1000 R23



**NEW**



DT-2P-M

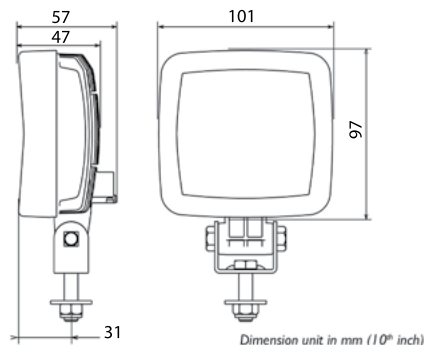

**D14857**  
(A0787A711300)

LED

12/24V  
14W

1000 Lumen

ADR

✓ R23 ✓ R10

E<sub>2</sub> 19140

IP69K

**NEW**



DT-2P-M



**D14880**  
(A0787A712400)

Aluminium

## RL 1500 R23



**NEW**



DT-2P-M

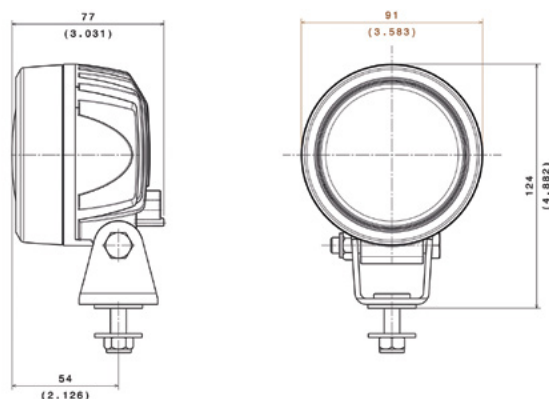

**D14858**  
(A0787A7395C3)

LED

12/24V  
20W

1500 Lumen

ADR

✓ R23 ✓ R10

E<sub>2</sub> 20078

IP69K

## 2963 R23



LED

12/24V  
14W

1000 Lumen

R23 R10

E11 7573

IP69K

**D14555**  
(29.63.L23.C0V) 1000 mm

**D14556\***  
(29.63.L21.CDV)



\* Interrupteur - switch - Schalter

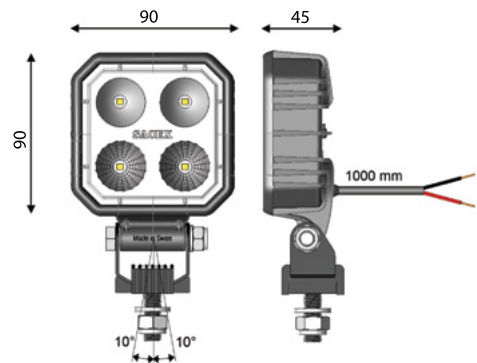

DT-2P-M

**D14759**  
(29.63.L23.CDV)

**NEW D14811\***  
(29.63.L21.CDV)



\* Interrupteur - switch - Schalter

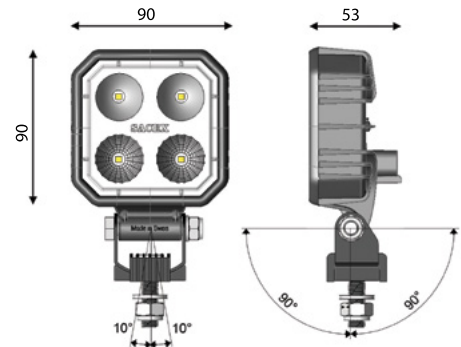

**D14170** DT-2P-F

## S H3 R23



H3/70W-24V

ADR

R23

E2 R23-07089

IP69



DT-2P-M



**D12390\***  
(A0782A736900)

Interrupteur - switch - Schalter

\* lampe fournie - bulb included - inklusiv Glühlampen

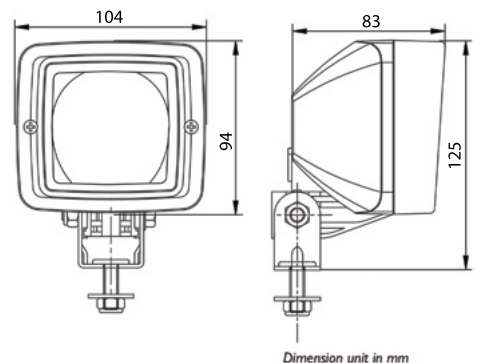

Dimension unit in mm

# Phares de travail

## Work lights

### Arbeitsscheinwerfer



## LED

p. 222-235



## Halogene

p.236-237



DT-2P-M

Type connecteur - Nb pins - Mâle ou Femelle  
Connector type - Pins Nb - Male or Female  
Steckertyp - Stifte Nb - männlich oder weiblich



Flashez le QR code pour plus d'infos  
Scan the QR code for more info  
Scannen Sie den QR-Code für weitere Informationen



Pièces détachées  
Spare parts  
Ersatzteile



Faisceau p. 301  
Harness p. 301  
Anschlusskabel siehe S. p. 301



Vitre en verre trempé  
Tempered glass lens  
Lichtsceibe aus gehärtetem Glas



Vitre en polycarbonate  
Polycarbonate lens  
Lichtsceibe aus Polycarbonat

# Phares de travail - Work lights - Arbeitsscheinwerfer



OE Original Parts



Nouveau! Éclairer plus loin et plus large  
 CEM CISPR25 Classe 5 (la plus haute protection électromagnétique) - Load dump intégré  
 New! Light up further and wider  
 EMC CISPR25 Class 5 (the highest electromagnetic protection) - Load dump integrated  
 Neu! Leuchten Sie weiter und weiter  
 EMC CISPR25 Klasse 5 (der höchste elektromagnetische Schutz) - Load Dump integriert

## SL 1000



**NEW**



DT-2P-M

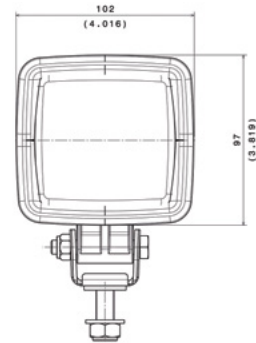
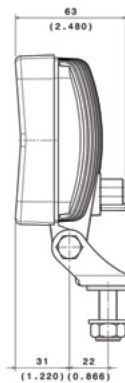

**LED**

12/24V  
14W

1000 Lumen

IP69K

**D14970**  
(A0787A742300)

**NEW**



DT-2P-M

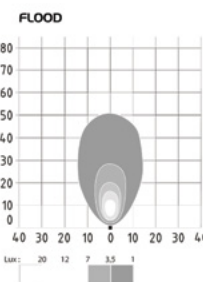

**D14850**  
(A0787A710700)

## SL 1500



**NEW**



DT-2P-M

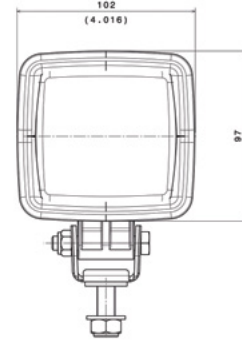
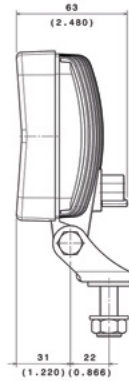

**LED**

12/24V  
20W

1500 Lumen

**IP69K**

**D14971**  
(A0787A742400)

**NEW**



DT-2P-M



**FLOOD**

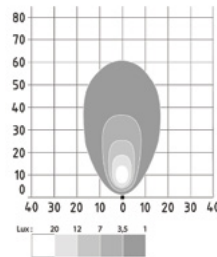

**D14851**  
(A0787A710800)

## SLA 2000



**NEW**



DT-2P-M

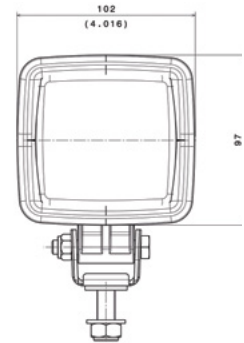
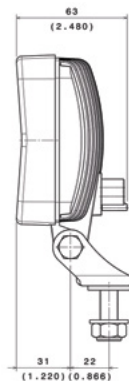

**LED**

12/24V  
29W

2000 Lumen

**IP69K**

**D14852**  
(A0787A710900)

Aluminium

**NEW**



DT-2P-M



**FLOOD**

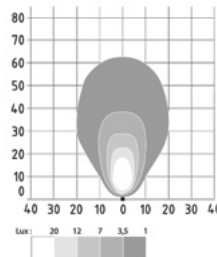

**D14856**  
(A0787A711700)

Aluminium



## SLA 2000 NO GLARE



**NEW**



DT-2P-M

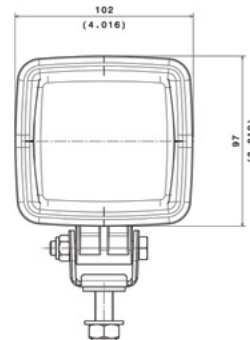
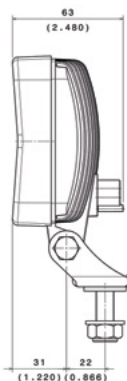

**LED**

12/24V  
29W

2000 Lumen

**IP69K**

**D14968**  
(A0787A7284C3)

Aluminium



N'éblouit ou n'aveugle pas - Éclaire la zone de travail  
No blinding or dazzling - Illuminates work area  
Kein Blenden - Beleuchtet den Arbeitsbereich



## RL 1000



**NEW**



DT-2P-M

LED

12/24V  
14W

1000 Lumen

IP69K

**D14853**  
(A0187A711000)

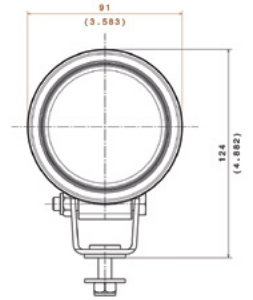
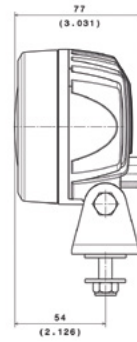
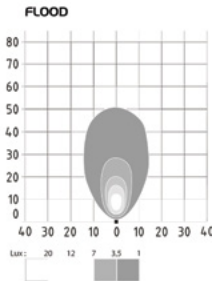

## RL 1500



**NEW**



DT-2P-M

LED

12/24V  
20W

1500 Lumen

IP69K

**D14854**  
(A0187A711100)

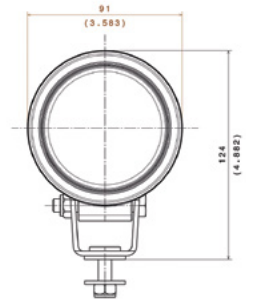
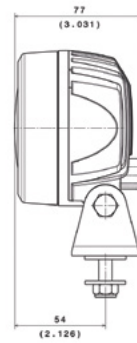
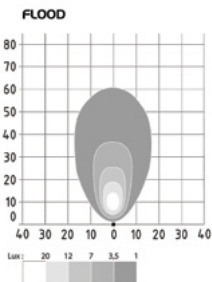

## RLA 2000



**NEW**



DT-2P-M

LED

12/24V  
29W

2000 Lumen

IP69K

**D14855**  
(A0187A711200)

Aluminium

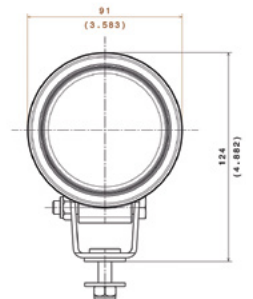
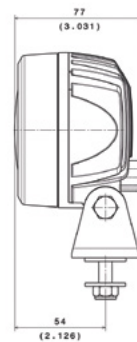
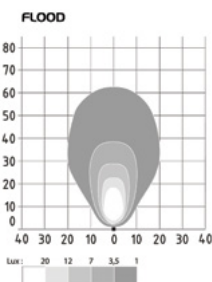

## OLA 1000



**NEW**



DT-2P-M

**LED**

12/24V  
14W

1000 Lumen

IP69K

**D14965**  
(A0487A7402C3)

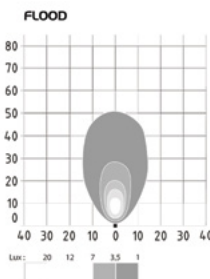

## OLA 1500



**NEW**



DT-2P-M

**LED**

12/24V  
20W

1500 Lumen

IP69K

**D14966**  
(A0487A7406C3)

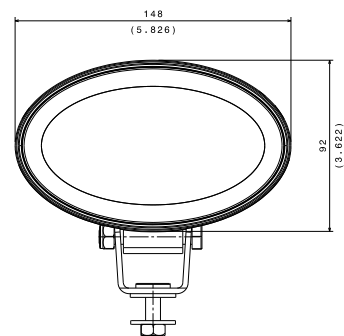
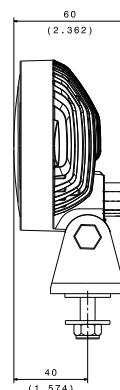
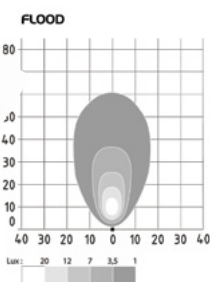

## OLA 2000



**NEW**



DT-2P-M

**LED**

12/24V  
29W

2000 Lumen

IP69K

**D14967**  
(A0487A7200C3)

Aluminium

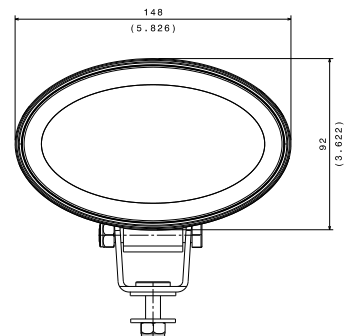
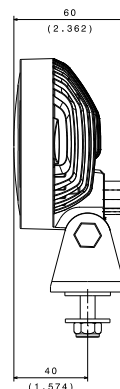
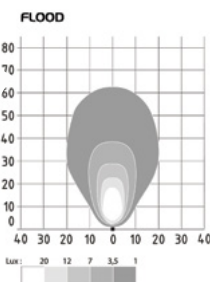

## SHD 1000



DT-2P-M

LED

9/36V  
11 W

1000 Lumen

IP69K

**D14160**  
(A0787A656800)

Aluminium

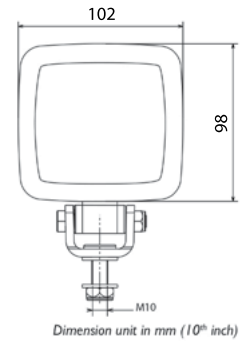
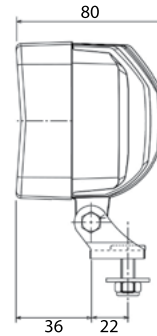
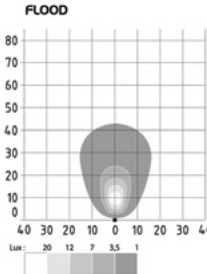

## SHD 1200



DT-2P-M

LED

9/36V  
20 W

1200 Lumen

IP69K

**D14161**  
(A0787A656900)

Aluminium

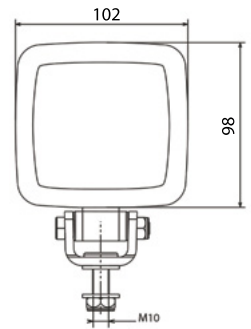
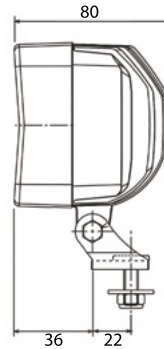
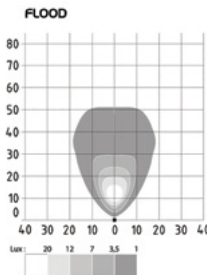

## SHD 3000



DT-2P-M

LED

12/24-100V  
38 W

3000 Lumen

IP69K

**D14447**  
(A0787A682200)

Aluminium

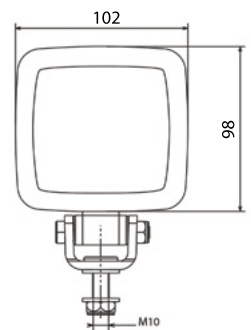
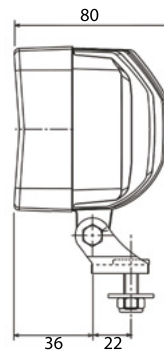
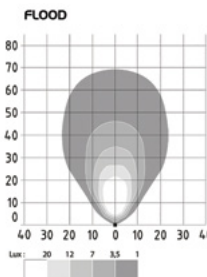

## SHD 5000



DT-2P-M

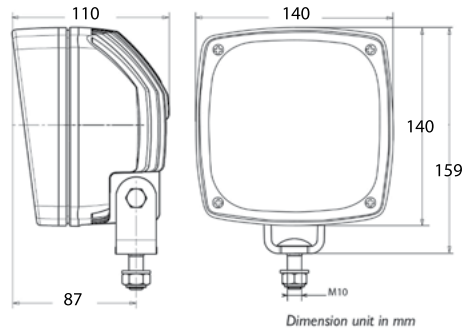

LED

12/24-100V  
57 W

5000 Lumen

IP69K

**D14387**  
(A0727A615900)  
Aluminium

## SHD 8000 LED



DT-2P-M

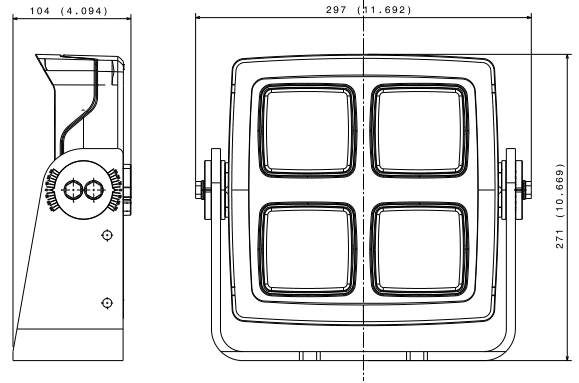

LED

12/24V  
90 W

8000 Lumen

IP69K

**Ref sur demande**  
P/N on request - Artikelnummer auf Anfrage



Feu de travail LED Heavy Duty modulaire  
Modular Heavy Duty LED work light  
Modularer LED Heavy Duty Arbeitsscheinwerfer



Long range

Flood



Long range  
+ Indicator

Flood  
+ Stop



## BL15



LED

24V



E2 16007  
10R-0516079

Affectations constructeurs  
OE applications  
Fahrzeugverwendung

CHEREAU p. 19  
FRUEHAUF p. 35  
LECAPITAINE p. 65  
TROUILLET p. 123

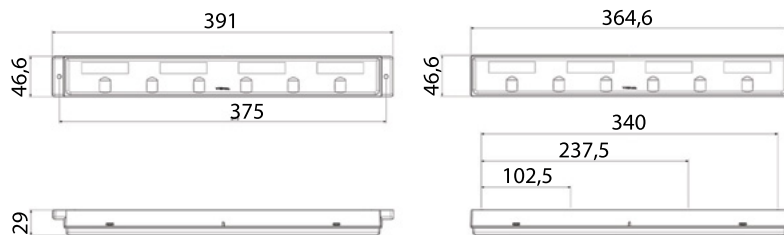

**165020**  
gauche - left - links



DT04-4P-M



DTM06-4S-4P-F

Fixation par l'arrière  
Back fixation  
Rückenfixierung



**165030**  
droit - right - rechts



**165040**  
gauche - left - links

Fixation par l'avant  
Front fixation  
Frontfixierung



**165050**  
droit - right - rechts



**D14436** DT06-4S-4P-F



**D14435** DTM04-4P-M

Indicateur de direction à défilement - feux de détresse flash  
Dynamic indicator lights - warning lights  
Dynamischer Blinker - blinkende Warnleuchte

Feu de travail 1200 Lumen  
Work light 1200 Lumen  
Arbeitsscheinwerfer 1200 Lumen

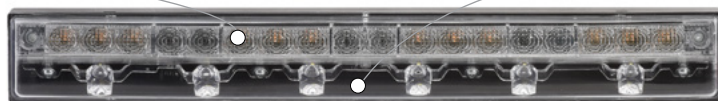

# CARBONLUX



COMPACT - KOMPAKT  
LEGER - LIGHT - LEICHT  
TECHNO-RESINE CARBONE - TECHNO-RESIN CARBON - KARBONHARZ  
OPTIQUE DOUBLE - DOUBLE OPTICS - DOPPELTE OPTIK

## 2960



**D14540**  
(29.60.L00.C0V) 1000 mm

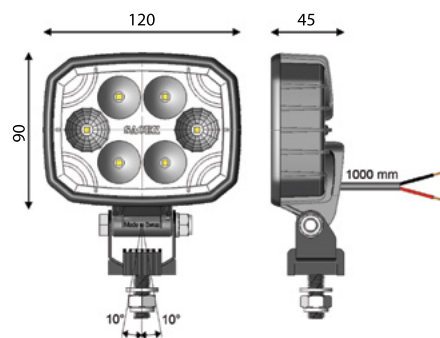

LED

10/30V  
12 W

1500 Lumen

R10

IP69K



**D14541**  
(29.60.L00.CDV)



DT-2P-M

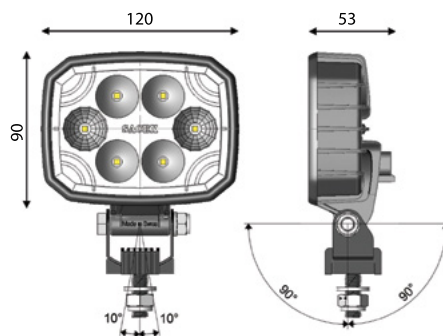

**D14170** DT-2P-F

## 2961



LED

10/30V  
12 W

1500 Lumen

R10

IP69K



**D14542**  
(29.61.L00.C0V) 1000 mm



**D14543**  
(29.61.L00.CDV)



DT-2P-M

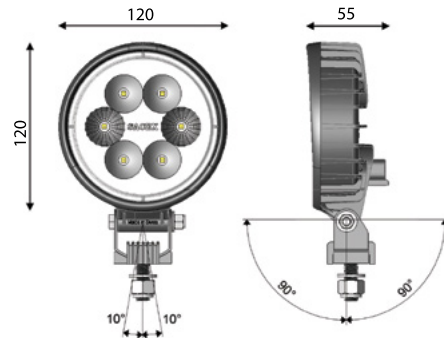
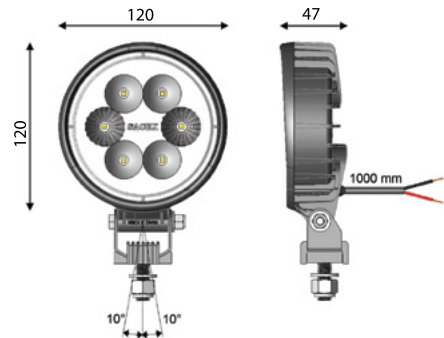

## 2962



LED

10/30V  
12 W

1500 Lumen

R10

IP69K



**D14544**  
(29.62.L00.C0V) 1000 mm



**D14545**  
(29.62.L00.CDV)



DT-2P-M

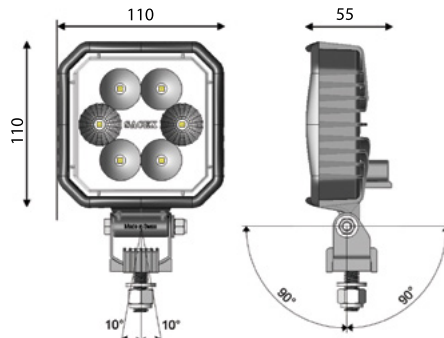
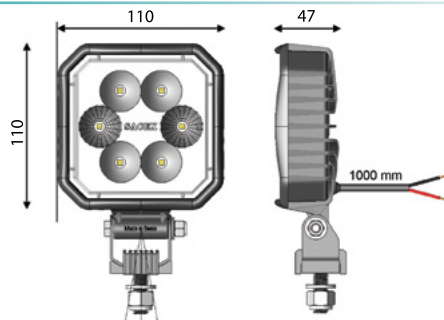

**D14546**  
(29.62.LV0.CDV)

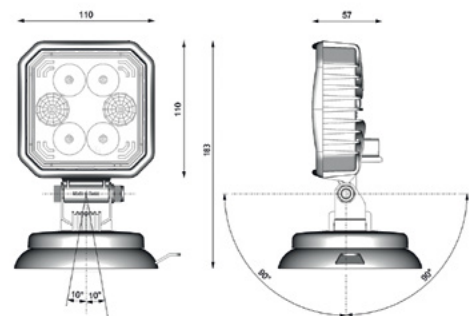



## 2963



**LED**

10/30V  
9 W

1000 Lumen

**R10**

**IP69K**

PC



**D14547**  
(29.63.L00.C0V) 1000 mm

PC



**D14552**  
(29.63.LA0.C0V) 1000 mm

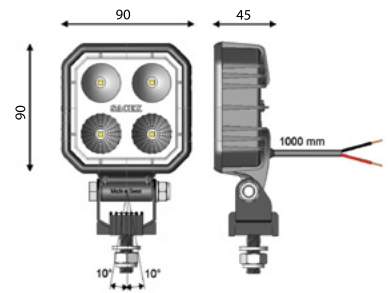

PC

FLOOD



**D14553**  
(29.63.L0A.C0V) 1000 mm

PC

SPOT



**D14554**  
(29.63.LSB.C0V) 1000 mm



PC



**D14548**  
(29.63.L00.CDV)



DT-2P-M

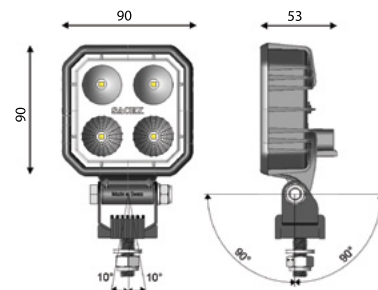

**D14170** DT-2P-F

## 2963



**LED**

10/30V  
9 W

1000 Lumen

**R10**

**IP69K**

\*Interrupteur - switch - Schalter

PC



**D14549 \***  
(29.63.LMI.COV) 1000 mm

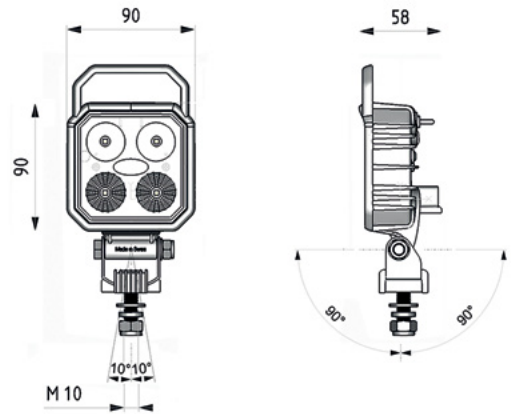

PC



**D14550 \***  
(29.63.LVX.CDV)

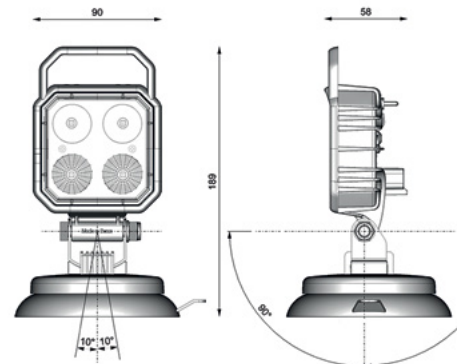

PC



**D14551 \***  
(29.63.L7X.COV)

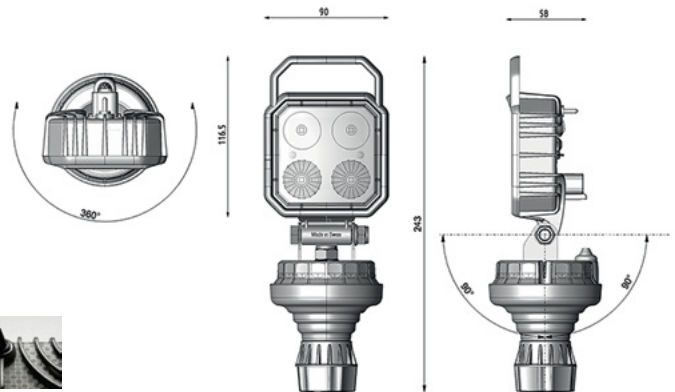

**D14514**

# Phares de travail - Work lights - Arbeitsscheinwerfer

## 2964



**LED**

10/30V  
12 W

2000 Lumen

**R10**

**IP69K**

PC



**D14557**  
(29.64.L00.C0V) 1000 mm

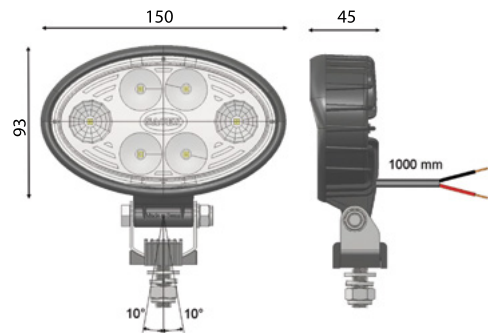

PC



**D14558**  
(29.64.LMI.C0V)



Interrupteur - switch - Schalter

## FTC



**LED**

12/24V  
15 W

850 Lumen

**IP69**



High power 100%  
Eco 30%  
Flash SOS



**D14191**  
batterie rechargeable  
rechargeable battery  
Akku

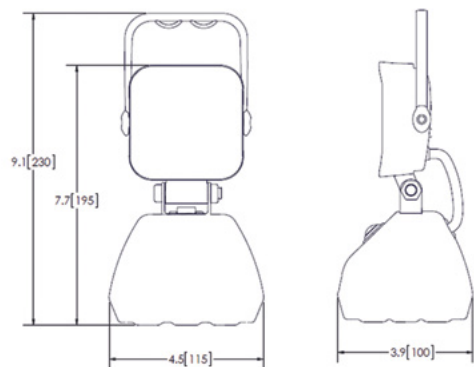

**D14192**  
prise adaptateur AC - AC adapter plug  
Wechselstromstecker

## RC 850 LED



LED

10/30V  
12 W

1500 Lumen

R10

IP69K

**NEW**



**D14743** 1000 mm

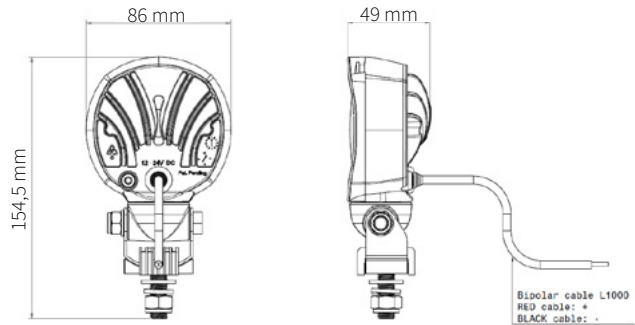

**NEW**



**D14744**



DT-2P-M

**NEW**



**D14745**

clippé - clipped - clip-befestigung

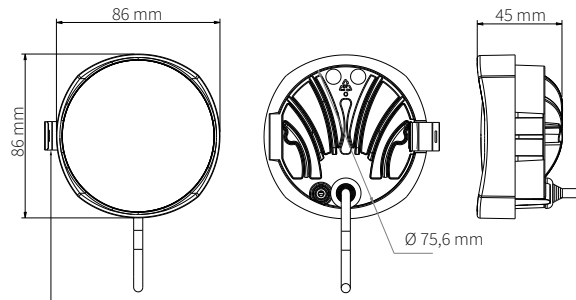

Compact (Ø 8,6 cm) et léger  
Compact (Ø 8,6 cm) and light  
Kompakt (Ø 8,6 cm) und leicht

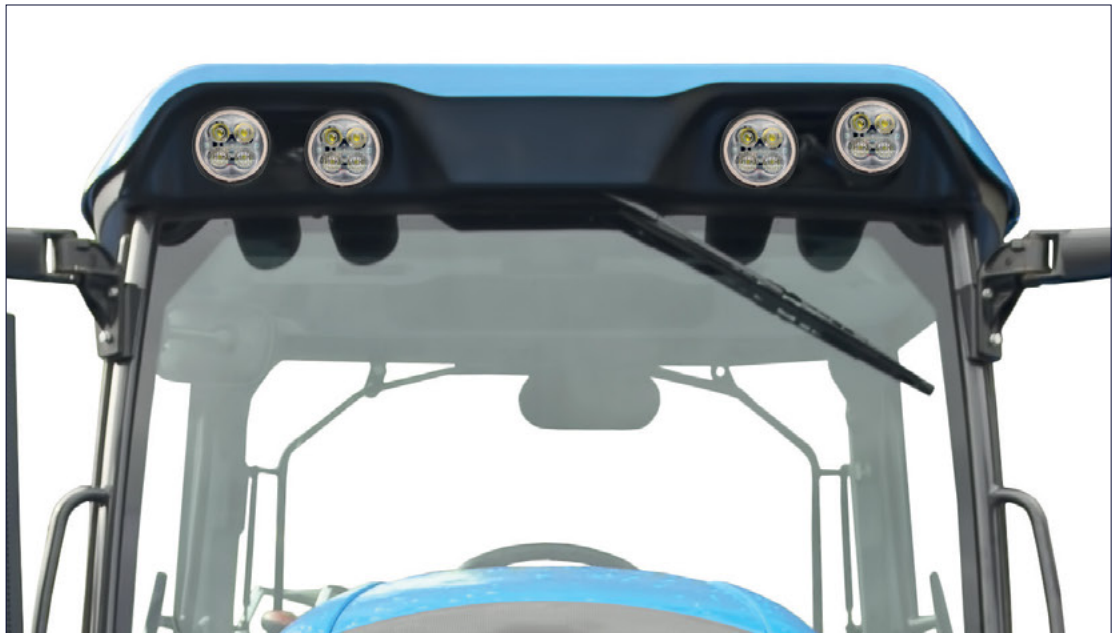

# Phares de travail - Work lights - Arbeitsscheinwerfer

## Q H3



H3/70W  
12/24/36/48/80V



IP66



DT-2P-M



**D14159**  
(A0782A736500)

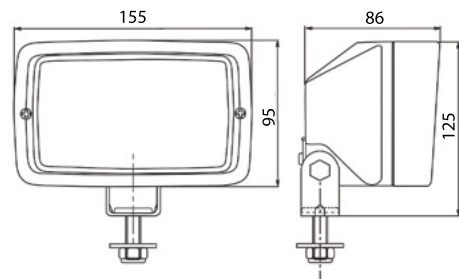

## R H3



H3/70W  
12/24/36/48/80V



IP66



DT-2P-M



**D14654**  
(A0166A736400)

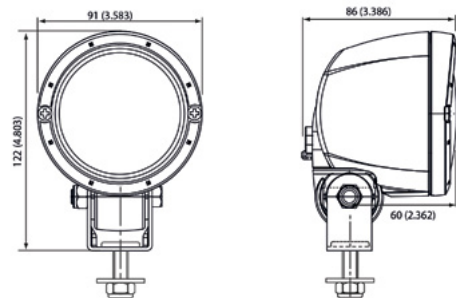

## S H3



H3/70W-24V  
H3/35W-24V ●



IP66



DT-2P-M



**D14156**  
(A0782A736500)

**D12488\***  
(A0782A736800) ●

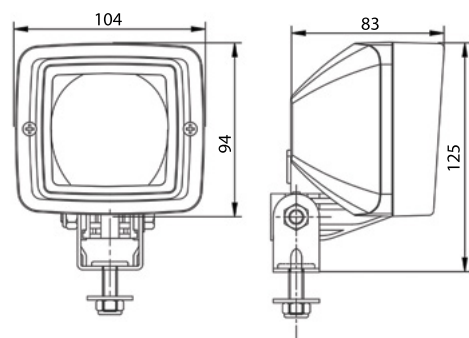

Dimension unit in mm

## S H3

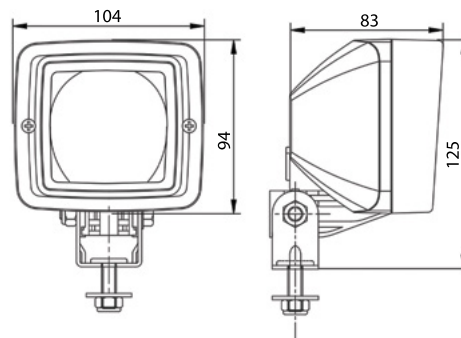

Dimension unit in mm

H3/70W-24V

IP66

Affectations constructeurs  
OE applications  
Fahrzeugverwendung

VOLVO TRUCKS p. 130

**D12111\***  
(A0782A639700)

\* lampe fournie - bulb included - inklusiv Glühlampen

## S H3



DT-2P-M

H3/70W-24V

IP66

Affectations constructeurs  
OE applications  
Fahrzeugverwendung

RENAULT TRUCKS p. 89  
SCANIA p. 116  
VOLVO TRUCKS p. 134

**D13019\***  
(A0782A563700)

\* lampe fournie - bulb included - inklusiv Glühlampen

# Éclairage de sécurité Warning lights Sicherheitsbeleuchtungen



DT-2P-M

Type connecteur - Nb pins - Mâle ou Femelle  
Connector type - Pins Nb - Male or Female  
Steckertyp - Stifte Nb - männlich oder weiblich



Vitre en verre trempé  
Tempered glass lens  
Lichtscheibe aus gehärtetem Glas



Flashez le QR code pour plus d'infos  
Scan the QR code for more info  
Scannen Sie den QR-Code für weitere Informationen

## SHD BLUE RED

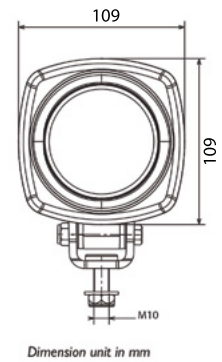
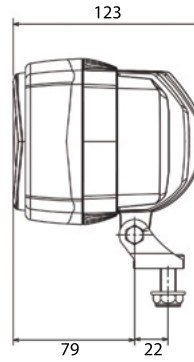

Dimension unit in mm

LED

12/24-100V  
5W



IP69



**D14249**  
(A0787A625500)



DT-2P-M

**D14653**  
(A0787A677400)



DT-2P-M

**D14250**  
(A0787A625600)



AMP-2P-M



## QL LED



SPOT OU FLECHE - SPOT OR ARROW - SPOT  
ODER PFEIL



DT-2P-M

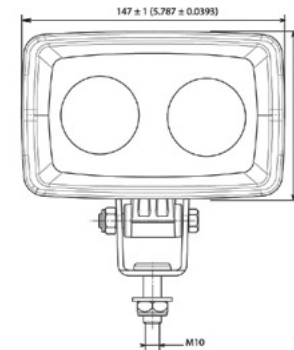
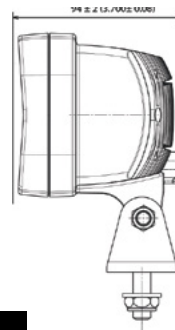

Dimension unit in mm (10<sup>th</sup> inc)

LED

12/24-100V  
7W



IP69



**D14769**  
(A0737A702600)



**D14770**  
(A0737A702700)



**D14771**  
(A0737A702800)



## WARNING LINE



COMPACT - KOMPAKT

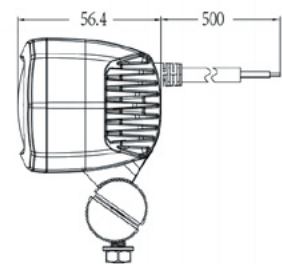
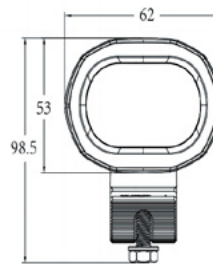

LED

12/24-80V  
6W



IP67



**D14357**



**D14358**





# Phares de conduite

## Headlights

### Fahrlichter



**NEW**



DT-2P-M

Type connecteur - Nb pins - Mâle ou Femelle  
Connector type - Pins Nb - Male or Female  
Steckertyp - Stifte Nb - männlich oder weiblich



Flashez le QR code pour plus d'infos  
Scan the QR code for more info  
Scannen Sie den QR-Code für weitere Informationen



Pièces détachées  
Spare parts  
Ersatzteile

## CHL 2 LED



LED

10/36V  
50W High Beam  
30W Low Beam

✓ ECE ✓ SAE

E R112 - R6 - R7

IP69K

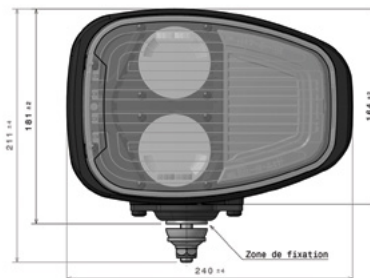
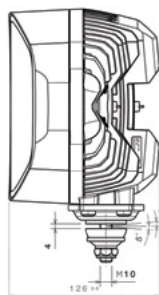

Feux de route - Feux de croisement - Indicateur de direction avant et latéral - Position  
High beam - Low beam - Front and side direction indicator - Position  
Fernlicht - Abblendlicht - Vorne und seite blinker - Position

**NEW**

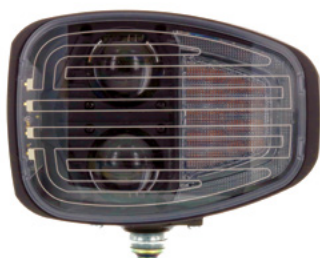

**D14964**  
(A0831A7333N3)

gauche - left - links



DT04-6P-M

**NEW**

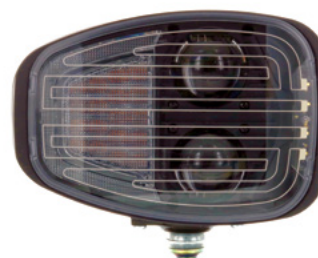

**D14963**  
(A0831A7332N3)

droit - right - rechts



**D14352**  
(A87005182400)

DT04-6P-F



Nouveau! Technologie de dégivrage active et autonome  
New! Active and autonomous de-icing technology  
Neu! Aktive und autonome Enteisungstechnologie

✓ SAE



**Ref** sur demande  
P/N on request - Artikelnummer auf Anfrage

## CHL 1 LED



**LED**

12/24V  
50W High Beam  
48W Low Beam

**✓ ECE**

**E** R112 - R6 - R7

**IP69**

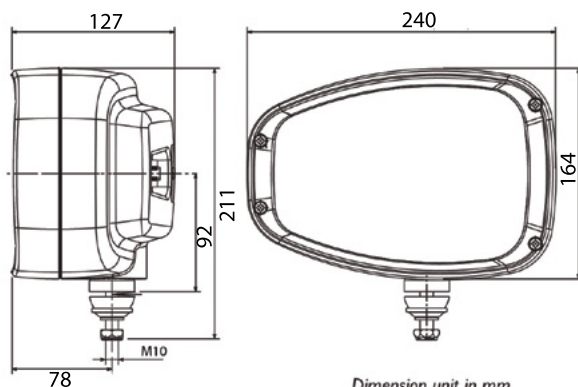

Feux de route - Feux de croisement - Indicateur de direction avant et latéral - Position  
High beam - Low beam - Front and side direction indicator - Position  
Fernlicht - Abblendlicht - Vorne und seite blinker - Position



**D14324**  
(A0831A673200)

gauche - left - links

**D14325**  
(A0831A673300)

droit - right - rechts



**D14352**  
(A87005182400)

DT04-6P-F

**✓ SAE**



**Ref sur demande**  
P/N on request - Artikelnummer auf Anfrage

## CHL1 H4



12/24V

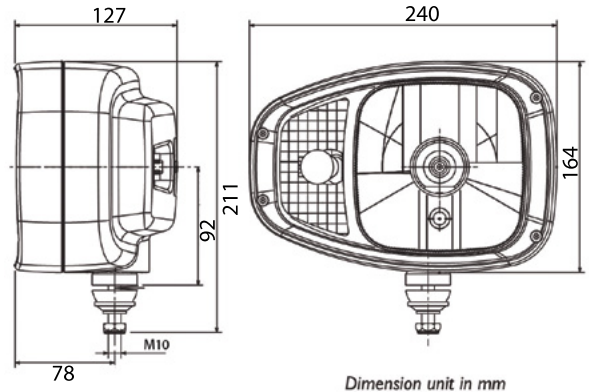
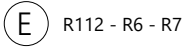

**D14320**  
(A0830A673600) 12V

**D14322**  
(A0830A673400) 24V

gauche - left - links



DT04-6P-M



**D14321**  
(A0830A673700) 12V

**D14323**  
(A0830A673500) 24V

droit - right - rechts



**D14352**  
(A87005182400)

DT04-6P-F

## CL 1 LED OFR



LED

12/24V



5W Low Beam OFF Road

3W Turn light

2W Pilot light



IP69

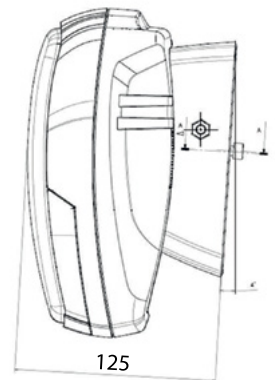
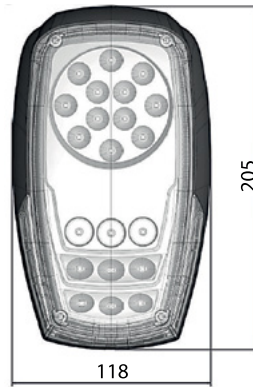

Feux de croisement - Indicateur de direction - Position  
Low beam - Direction indicator - Position  
Abblendlicht - Blinker - Position



**D14649**  
(A0801A699800)

gauche - left - links



ECONOSEAL



**D14649**  
(A0801A699800)

droit - right - rechts

# Feux auxiliaires

## Auxiliary lights

### Zusatzscheinwerfer



DT-3P-M

Type connecteur - Nb pins - Mâle ou Femelle  
Connector type - Pins Nb - Male or Female  
Steckertyp - Stifte Nb - männlich oder weiblich



Flashez le QR code pour plus d'infos  
Scan the QR code for more info  
Scannen Sie den QR-Code für weitere Informationen

## ALPHA 175 LED



**NEW**



DT-3P-M

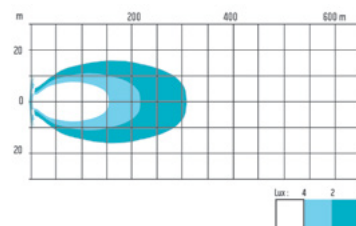
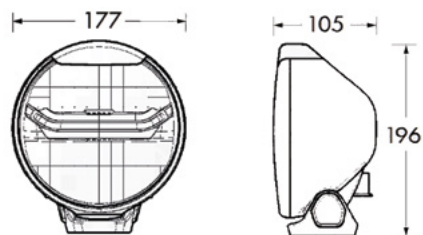

**LED**

10/33V  
35W High beam  
2,3W Position

4300 Lumen

\* connecteur fourni -  
connector included - inklusiv  
anschlusstecker

**D14167\***  
(A0342A699900)

## ALPHA 225 LED



**NEW**



DT-3P-M

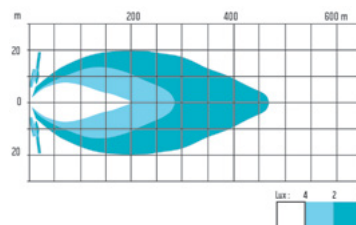
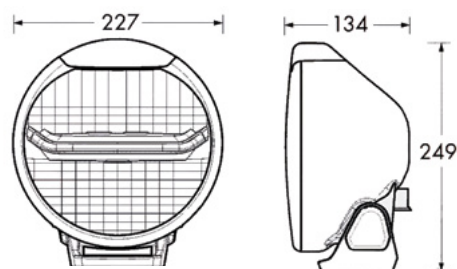

**LED**

10/33V  
50W High beam  
2,3W Position

6200 Lumen

\* connecteur fourni -  
connector included - inklusiv  
anschlusstecker

**D14993\***  
(A0332A745400)

## ALPHA 225 LED



DT-3P-M

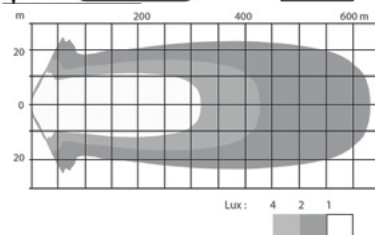
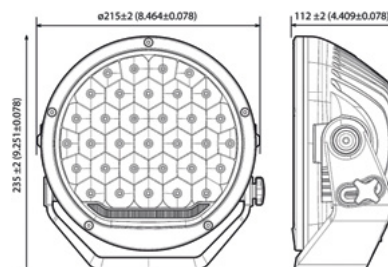

**LED**

10/33V  
150W High beam  
2,3W Position

8500 Lumen



**IP67**

\* connecteur fourni -  
connector included - inklusiv  
anschlusstecker

**D14673\***  
(A0342A699900)

## ALPHA 225 XENON



 35W-D1S GEN5  
24V  
43 W

 16903

\* lampe fournie - bulb included - inklusiv glühlampen

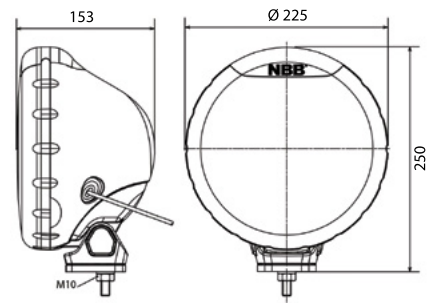

Dimension unit in mm

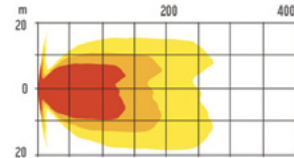

**D14165\***  
(A0331A657300)

## ALPHA 225



 H1-12/24V  
70W Max

 16902

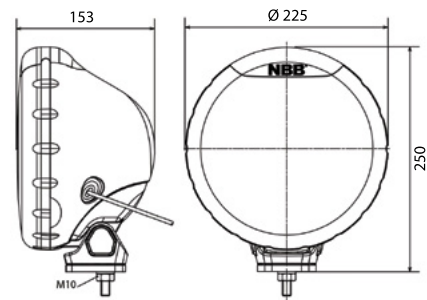

in mm

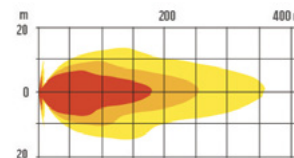

**D14166**  
(A0330A657400)



# Éclairage intérieur

## Interior lights

### Innenraum-Beleuchtungen



**NEW**



DT-2P-M

Type connecteur - Nb pins - Mâle ou Femelle  
Connector type - Pins Nb - Male or Female  
Steckertyp - Stifte Nb - männlich oder weiblich



Flashez le QR code pour plus d'infos  
Scan the QR code for more info  
Scannen Sie den QR-Code für weitere Informationen



Pièces détachées  
Spare parts  
Ersatzteile

# Éclairage intérieur - Interior lights - Innenraum-Beleuchtungen

## 2250



LED

10-30V

R10

IP69

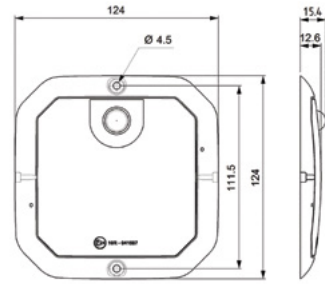
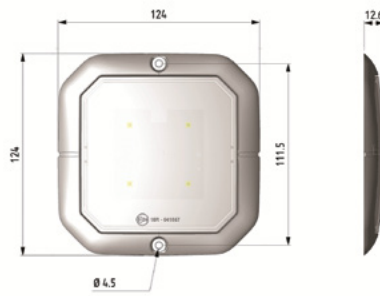

> 4 m <  
timer 5 min  
500 Lumen

**D14569**  
(22.50.LP4.VLG) 4 LEDS - PIR

Avec détecteur de mouvement et chaleur (capteur PIR) - with motion and heat detector (PIR sensor) - Mit Bewegungs- und Wärmemelder (PIR sensor)



> 4 m <  
timer 5 min  
500 Lumen

**MASTER**  
**D14598**  
(22.50.LP4.MSV) 4 LEDS - PIR

Avec détecteur de mouvement et chaleur (capteur PIR) - with motion and heat detector (PIR sensor) - Mit Bewegungs- und Wärmemelder (PIR sensor)



500 Lumen

**D14567**  
(22.50.L04.VLG) 4 LEDS

Sans détecteur de mouvement et chaleur (capteur PIR) - without motion and heat detector (PIR sensor) - ohne Bewegungs- und Wärmemelder (PIR sensor)



750 Lumen

**D14568**  
(22.50.L06.VLG) 6 LEDS

Sans détecteur de mouvement et chaleur (capteur PIR) - without motion and heat detector (PIR sensor) - ohne Bewegungs- und Wärmemelder (PIR sensor)

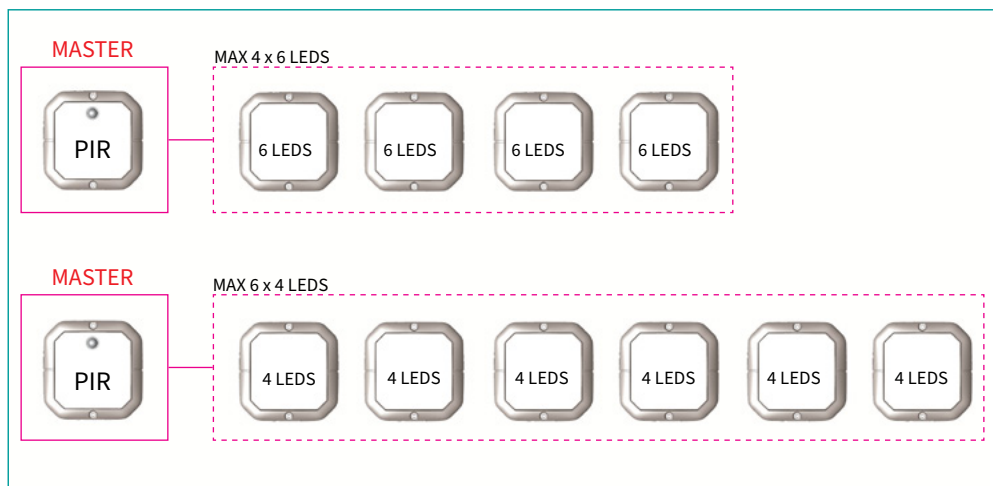

Exemple de montage Maître (PIR) + Esclaves - Assembly suggestion  
Master (PIR) + Slaves - Montagebeispiel Meister (PIR) + Sklave

# Éclairage intérieur - Interior lights - Innenraum-Beleuchtungen

## RCL 1200

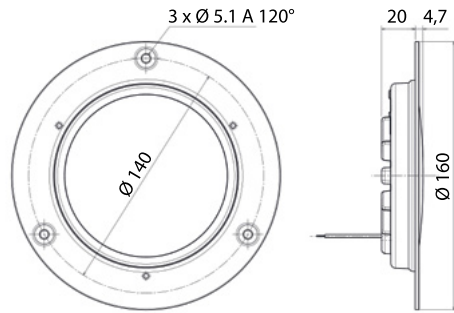

**LED**



9-30V



1200 Lumen



R10



IP67

filš nus - naked cable extremity - Kabellitze



**300010**

6 LEDS



**NEW**



**300000**

6 LEDS

chromé - chrome-plated - verchromt

## FE02

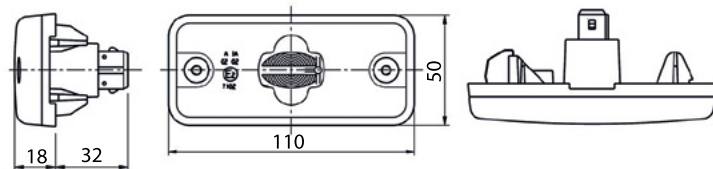

W5W - 12/24V



ADR



E<sub>2</sub> 7102



**102200**

**K**

clippé - clipped - clip-befestigung



**D13876**

**JPT-2P-F**



**001726**

# Gyrophares

## Beacons

### Rundumkennleuchten



**LED**  
p. 252-259



**Halogene**  
p. 260-263

 Montage sur tige  
DIN pole mounting  
Für Aufteckrohr

 Fixation à visser  
Screw mounting  
Schraubbefestigung

 Magnétique  
Magnetic  
Magnettuss

 LED Rotatif  
LED Rotative  
Rotierend LED

 LED à éclats  
LED Flash  
Blitze LED

 Polycarbonate  
Polycarbonate  
Polycarbonat



Flashez le QR code pour plus d'infos  
Scan the QR code for more info  
Scannen Sie den QR-Code für weitere Informationen



Indice de protection IP - solides/liquides  
IP ingress protection - solids/liquids  
IP Schutzfaktor - Fremdkörper/Wasser



Pièces détachées  
Spare parts  
Ersatzteile



Homologation circulation réseau routier public  
Approval circulation on public road network  
Genehmigung des öffentlichen Straßennetzes



Homologation CEM - compatibilité électromagnétique  
EMC approval - Electromagnetic Compatibility  
EMV zulassung - Elektromagnetische Verträglichkeit



Accessoires p. 263  
Accessories p. 263  
Zubehör S. p. 263

# Gyrophares - Beacons - Rundumkennleuchten

## ATLAS



LED

10/30V  
11 W - 17 W

✓ R65 ✓ R10

IP6K9K



Affectations constructeurs  
OE applications  
Fahrzeugverwendung

CLAAS p. 22  
DE BUF p. 29  
HYUNDAI CE p. 42  
MAN p. 70

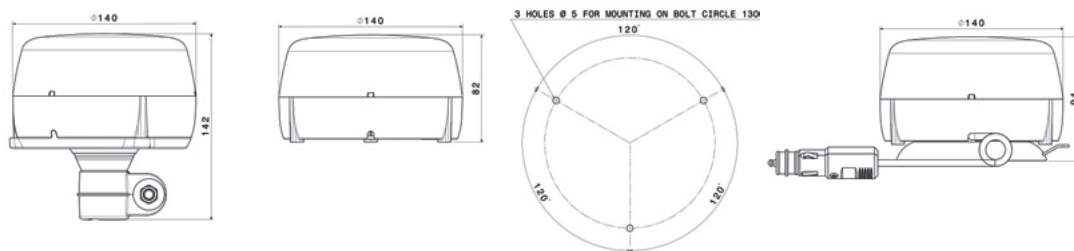

**212420**



CEM Class 5

**NEW**



**212400**



CEM Class 3  
CLAAS p. 22



**212470**



CEM Class 5



**212120**



**212160**  
fils nus - naked cable extremity - Kabellitze  
CEM Class 5



**212020**



CEM Class 5  
MAN p. 70



**212030**



CEM Class 5  
MAN p. 70



Durée de vie optimale - Gestion thermique des Leds - CEM Classe 5  
Optimum service life - LED thermal management - EMC Class 5  
Optimale Lebensdauer - LED-Thermomanagement - EMV-Klasse 5



**D13879**

POS-2P-F



# Gyrophares - Beacons - Rundumkennleuchten

## ATLAS



LED

10/30V  
11 W - 17 W

R65 R10

IP69



Affectations constructeurs  
OE applications  
Fahrzeugverwendung

MERCEDES p. 76  
RENAULT TRUCKS p. 86  
SAME p. 114  
VOLVO p. 130

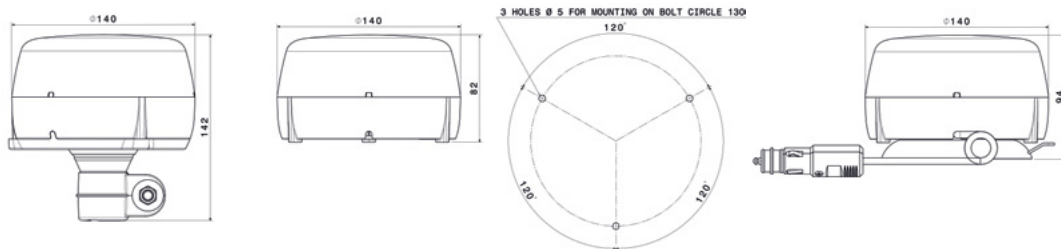

**NEW**



**212730**

CEM Class 5  
VOLVO p. 130



TYCO MCON-2P-M



**212170**

CEM Class 5  
fils nus - naked cable extremity - Kabellitze



**NEW**



**212710**

CEM Class 5  
MERCEDES p. 76



MQS-2P-M



**212010**

CEM Class 4  
MERCEDES p. 76



KOSTAL-2P-M

**NEW**



**212740\***

CEM Class 5  
RENAULT TRUCKS p. 86



AMP-4P-F

**NEW**



**212750\***

CEM Class 5  
RENAULT TRUCKS p. 86



AMP-4P-F

\*212740 - 212750  
Disponible en 09/2021  
Available in 09/2021  
Verfügbar in 09/2021



**212520**



**212560**

CEM Class 5



**212570**

CEM Class 5



# Gyrophares - Beacons - Rundumkennleuchten

## PEGASUS



LED

10/30V  
9 W

✓ R65 ✓ R10



\* Multifunction - Multifunktions  
\*\* Rotative - Rundumlauf

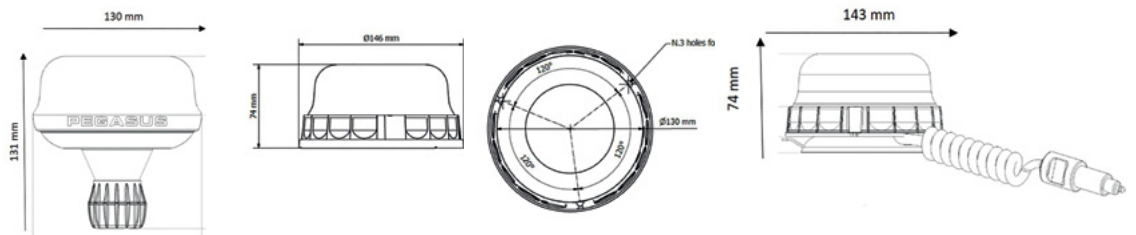

3 Types de flash homologués ECE R65  
3 Flash patterns certified ECE R65  
3 Blitzarten ECE R65 zugelassen



FLEXI

**D14501**  
(21.50.L75.5V8) Multifonction\*

**D14725**  
(21.50.L75.3V8) Rotatif\*\*



**D14500**  
(21.50.L35.5V8) Multifonction\*

**D14724**  
(21.50.L35.3V8) Rotatif\*\*



**D14502**  
(21.50.LV5.5V8) Multifonction\*

**D14726**  
(21.50.LV5.3V8) Rotatif\*\*



**D14503**  
(21.50.811.MUV) Multifonction\*

cabochon - lens - Lichtscheibe



FLEXI

**D14757**  
(21.50.L75.51V) Multifonction\*



**D14756**  
(21.50.L35.51V) Multifonction\*



**D14758**  
(21.50.LV5.51V) Multifonction\*



**D14747**  
(21.50.201.MUV) Multifonction\*

cabochon - lens - Lichtscheibe

## GALAXY LED



LED

10/30V  
9 W

✓ R65 ✓ R10

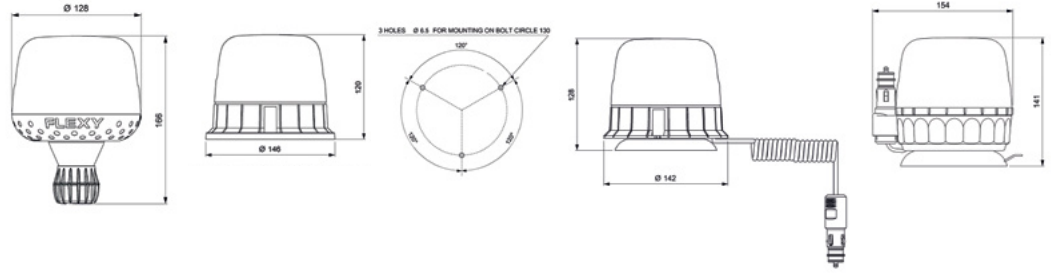

FLEXI

**D14488**  
(21.49.L75.3V8)



**D14487**  
(21.49.L35.3V8)



**D14489**  
(21.49.LV5.3V8)



**D14493**  
(21.49.L75.1V8)



**D14492**  
(21.49.L35.1V8)



**D14494**  
(21.49.LV5.1V8)



**D14490**  
(21.49.LR5.3V8)



**D14495**  
(21.49.LR5.1V8)



ROLL CABLE



**D14755**  
(21.49.LR5.11V)



ROLL CABLE



FLEXI

**D14753**  
(21.49.L75.11V)



**D14752**  
(21.49.L35.11V)



**D14754**  
(21.49.LV5.11V)



**D14491**  
(2149.815.RTV)



**D14496**  
(2149.815.LMV)



cabochon - lens - Lichtscheibe

**D14779**  
(21.49.801.VLG)



cabochon - lens - Lichtscheibe



# Gyrophares - Beacons - Rundumkennleuchten

## VENUS LED

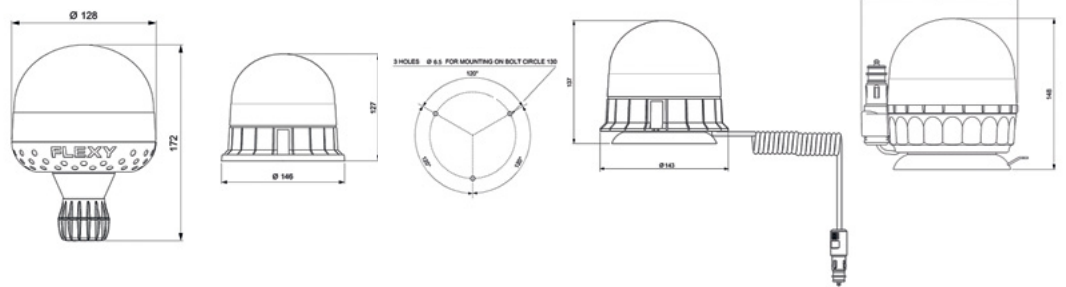

LED

10/30V  
9 W

✓ R65 ✓ R10



DOUBLE FLASH  
DOPPELBLITZ



FLEXI

**D14728**  
(21.43.L75.2V8)



**D14727**  
(21.43.L35.2V8)



**D14729**  
(21.43.LV5.2V8)



**D14730**  
(21.43.LR5.2V8)



**D14731**  
(21.43.815.VLG)

cabochon - lens - Lichtscheibe

## VEGA LED

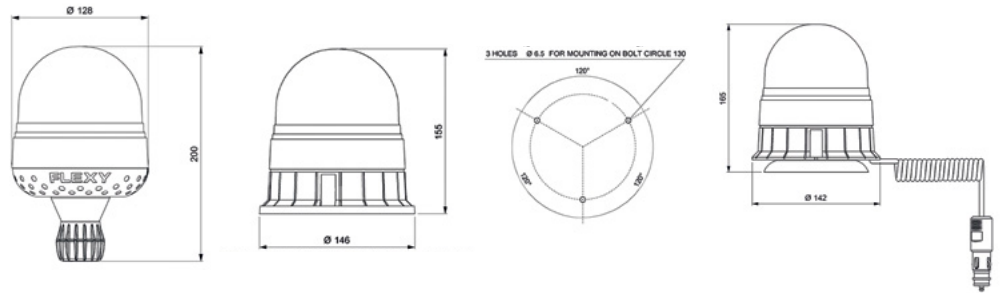

LED

10/30V  
9 W

✓ R65 ✓ R10



**D14508**  
(21.87.L75.3V8)



**D14507**  
(21.87.L35.3V8)



**D14509**  
(21.87.LV5.3V8)



**D14510**  
(21.87.815.RTV)

cabochon - lens - Lichtscheibe

## TAURUS LED



LED

10/30V  
9 W

✓ R65 ✓ R10

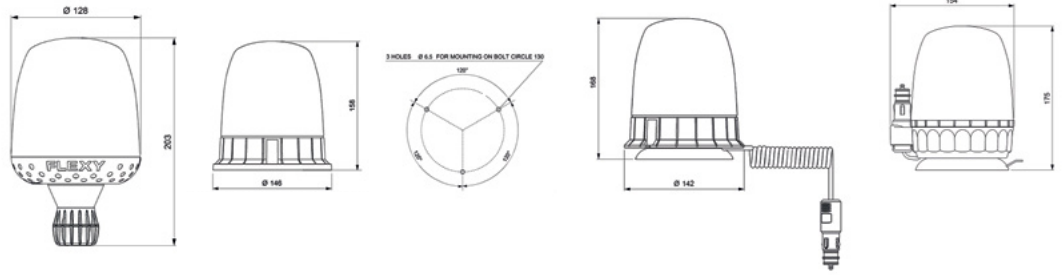

FLEXI

**D14483**  
(21.48.L75.3V8)



**D14482**  
(21.48.L35.3V8)



**D14485**  
(21.48.LV5.3V8)



**D14484**  
(21.48.LR5.3V8)



ROLL CABLE

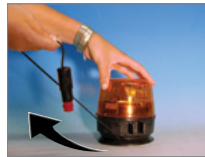

**D14734**  
(21.48.LR5.15V)



ROLL CABLE



FLEXI

**D14733**  
(21.48.L75.15V)



**D14732**  
(21.48.L35.15V)



**D14735**  
(21.48.LV5.15V)



**D14486**  
(2148.815.RTV)

cabochon - lens - Lichtscheibe



**D14736**  
(2148.855.LMV)

cabochon - lens - Lichtscheibe

## SATURNELLO LED



LED

10/30V  
9 W

✓ R65 ✓ R10

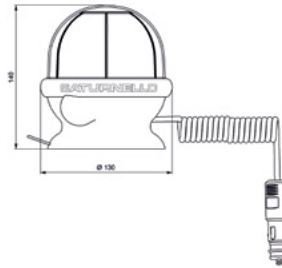
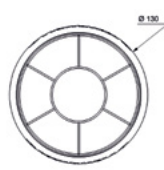

FLEXI

**D14737**  
(21.88.L85.3V8)



**D14738**  
(21.88.LV5.3V8)



**D14739**  
(21.88.815.VLG)

cabochon - lens - Lichtscheibe

## MINI SATURNELLO LED



LED

10/30V  
9 W

✓ R65 ✓ R10

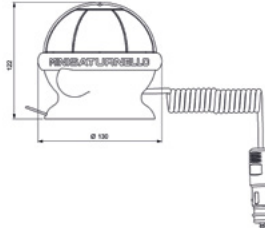

FLEXI

**D14740**  
(21.83.L85.3V8)



**D14741**  
(21.83.LV5.3V8)



**D14742**  
(21.83.815.VLG)

cabochon - lens - Lichtscheibe

# Gyrophares - Beacons - Rundumkennleuchten

## PUCK



LED

10/30V  
3,5 W

R10

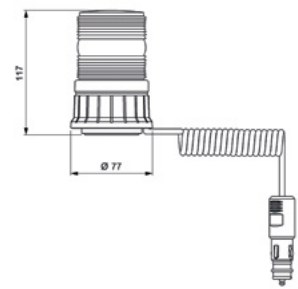
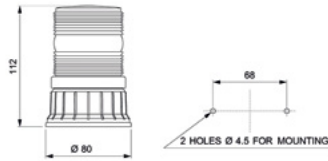
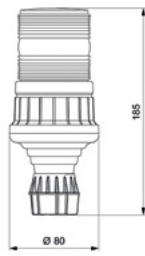

FLEXI

**D14453**  
(21.38.L75.2VL)



**D14451**  
(21.38.L35.2VL)



**D14452**  
(21.38.LM5.2VL)



COMPACT - KOMPAKT



## FRESNEL



LED

10/110V  
3,5 W

R10

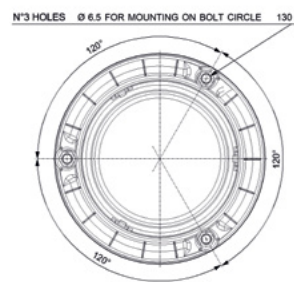
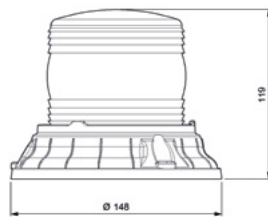

**D14746**  
(21.37.L35.2VL)

# Gyrophares - Beacons - Rundumkennleuchten

## GALAXY



H21W



12/24V  
23W



lamps 12/24V fournies  
- 12/24V bulbs included -  
inklusive Glühlampen 12/24V

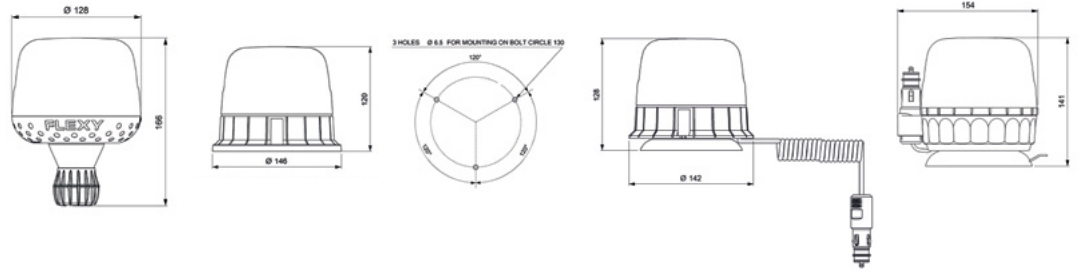

FLEXI

**D14749**  
(21.49.H75.VLG)



**D14748**  
(21.49.H35.VLG)



**D14750**  
(21.49.HV5.VLG)



**D14751**  
(21.49.HR5.VLG)



ROLL CABLE



**D14778**  
(21.49.811.VLG)

cabochon - lens - Lichtscheibe

## VENUS



H21W



12/24V  
23W



lamps 12/24V fournies  
- 12/24V bulbs included -  
inklusive Glühlampen 12/24V

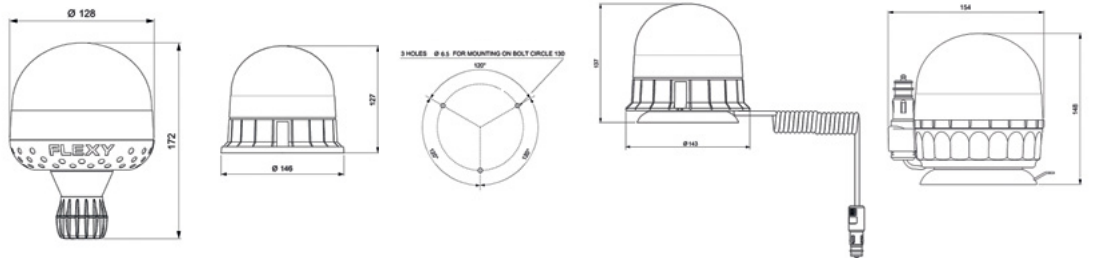

FLEXI

**D14463**  
(21.43.H65.VLG)



**D14462**  
(21.43.H35.VLG)



**D14464**  
(21.43.HV5.VLG)



**D14465**  
(21.43.HR5.VLG)



ROLL CABLE



**D14466**  
(21.43.811.VLG)

cabochon - lens - Lichtscheibe

# Gyrophares - Beacons - Rundumkennleuchten

## TAURUS



H21W

12/24V  
23W



lampes 12/24V fournies - 12/24V bulbs included - inklusiv Glühlampen 12/24V

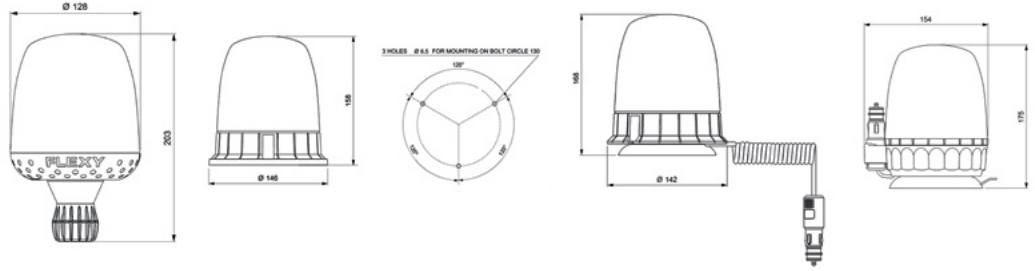

FLEXI

**D14470**  
(21.48.H75.VLG)



**D14467**  
(21.48.H35.VLG)



**D14468**  
(21.48.HV5.VLG)



**D14469**  
(21.48.HR5.VLG)



ROLL CABLE



**D14471**  
(21.48.811.VLG)

cabochon - lens - Lichtscheibe

## VEGA



H1

12/24V  
55-70W



lampes 12/24V fournies - 12/24V bulbs included - inklusiv Glühlampen 12/24V

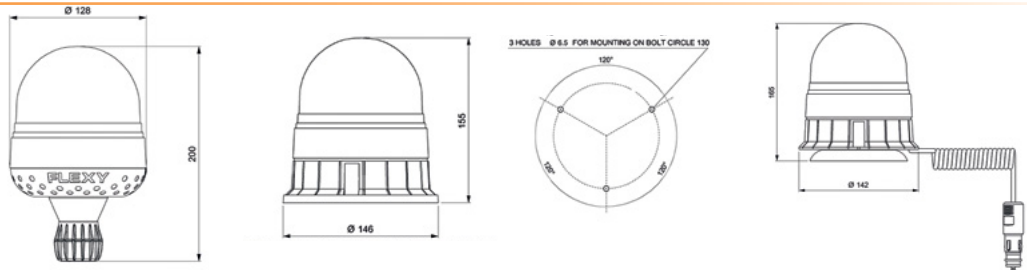

**D14479**  
(21.87.T75.VLG)



**D14477**  
(21.87.T35.VLG)



**D14478**  
(21.87.TV5.VLG)



**D14480**  
(21.87.811.VLG)

cabochon - lens - Lichtscheibe

# Gyrophares - Beacons - Rundumkennleuchten

## SATURNE



H1



12/24V  
55-70W



lampes 12/24V fournies  
- 12/24V bulbs included -  
inklusive Glühlampen 12/24V



FLEXI

**D14475**  
(21.82.T85.VLG)

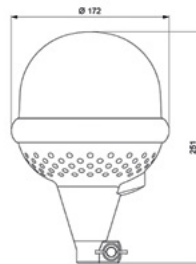

**D14476**  
(21.82.811.VLG)

cabochon - lens - Lichtscheibe

## GOUTTE



10/30V  
9 W



**D14481**  
(21.35.LMV.358)

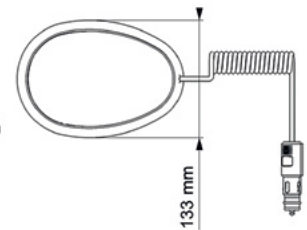
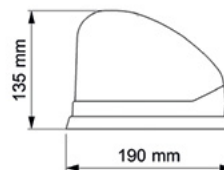

H1



12V



**D14454**  
(21.35.010.TVL)



**D14455**  
(21.35.050.TVL)



**D14456**  
(21.35.811.VLG)

cabochon - lens - Lichtscheibe



**D14457**  
(21.35.851.VLG)

cabochon - lens - Lichtscheibe



Exemple de montage - Assembly suggestion - Montagebeispiel



**D14514**  
(21.92.000.VLG)

tige avec support central - socket with central clamp - Aufsteckrohr mit zentralem Tragbuegel  
ISO 4148/4165



**D14513**  
(21.91.000.VLG)

tige à visser - socket to be screwed Aufsteckrohr zum Anschrauben  
ISO 4148/4165

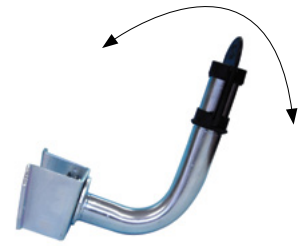

**D14515**  
(21.97.005.VLG)

tige articulée 360° - 360° rotating socket - Bewegbarer Aufsteckrohr 360°  
ISO 4148/4165



**D14511**  
(21.76.282.VLG)

semelle plate - flat gasket - Flache Sockeldichtung



**D14512**  
(21.76.283.VLG)

semelle inclinée - tilted gasket - Gekippte Sockeldichtung



Exemple de montage - Assembly suggestion - Montagebeispiel



**D14565** H21W 12V BAY9s  
(90.16.025.VLG)

**D14566** H21W 24V BAY9s  
(90.16.026.VLG)



# Rampes lumineuses

## Lightbars

### Warnbalken



**NEW**

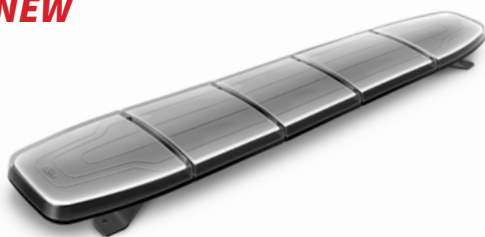

Fixation à visser  
Screw mounting  
Schraubbefestigung



Magnétique  
Magnetic  
Magnetfuss



Polycarbonate  
Polycarbonat  
Polycarbonat



Flashez le QR code pour plus d'infos  
Scan the QR code for more info  
Scannen Sie den QR-Code für weitere Informationen



Indice de protection IP - solides/liquides  
IP ingress protection - solids/liquids  
IP Schutzfaktor - Fremdkörper/Wasser



Pièces détachées  
Spare parts  
Ersatzteile



Homologation circulation réseau routier public  
Approval circulation on public road network  
Genehmigung des öffentlichen Straßennetzes



Homologation CEM - compatibilité électromagnétique  
EMC approval - Electromagnetic Compatibility  
EMV zulassung - Elektromagnetische Verträglichkeit

## STELLAR



LED

10/36V

✓ R65

✓ R10

✓ SAE



IP6K9K

**NEW**

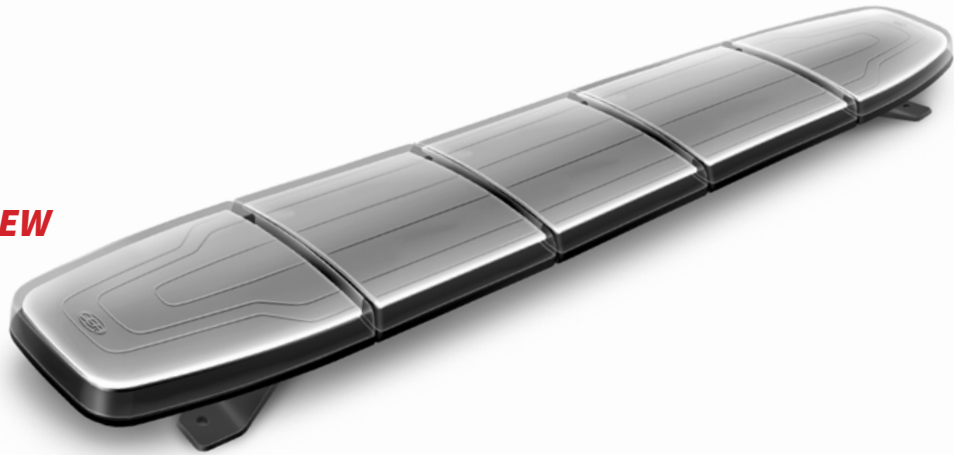

Modulaire et extra-plat - Circuit électronique plat - aucun câble intérieur  
Modular and extra-flat - Flat PCB - no internal cables  
Modular und extra flach - Flach-PCB - Internen Kabelfrei



# Rampes lumineuses - Lightbars - Warnbalken

## STELLAR



**NEW**

**LED**



10/36V



**IP6K9K**

Câble fils nus - naked cable  
extremity - Kabellitze

\* partie centrale opaque  
pour lettrages - opaque  
central part for lettering -  
undurchsichtiger Mittelteil  
zur Beschriftung



**D23300\***  
(2370R35050)

950 mm



**D23301**  
(2370R35000)

950 mm

-> Petits véhicules utilitaires, voirie  
-> Light vans or community vehicles  
-> Klein Nutzfahrzeuge, Gemeinschafts Fahrzeuge



**D23400\***  
(2371R35050)

1250 mm



**D23401**  
(2371R35000)

1250 mm

-> Véhicules utilitaires, voirie  
-> Vans or community vehicles  
-> Nutzfahrzeuge, Gemeinschafts Fahrzeuge



**D23500\***  
(2372R35055)

1550 mm



**D23501**  
(2372R35000)

1550 mm

-> Camions (3,5t à 19t)  
-> Trucks (3,5t to 19t)  
-> Lastkraftwagen (3,5t bis 19t)



**D23600\***  
(2373R35005)

1850 mm



**D23601**  
(2373R35000)

1850 mm

-> Camions (19t à 44t)  
-> Trucks (19t to 44t)  
-> Lastkraftwagen (19t bis 44t)



### Autres options et versions disponibles sur demande :

- Bleu véhicules prioritaires et d'urgences
- Phares de travail avant, arrière, latéraux
- Rappel stop, position, indicateur de direction
- Traffic master
- Interface véhicule mécanique et électronique

### Other options and versions available on request:

- Blue priority and emergency vehicles
- Work lights and alley lights
- Additional stop, position, direction indicator
- Traffic master
- Mechanical and electronic vehicle interface

### Weitere Optionen und Versionen auf Anfrage:

- Blaue Einsatz- und Notfallfahrzeuge
- Arbeitsscheinwerfer und Gassenlichter
- Zusätzlicher Bremslicht, Positionslicht, Richtungsanzeiger
- Verkehrsleitsystem
- Mechanische und elektronische vehicle Schnittstelle

## MULTILED



LED

10/30V  
18 W

✓ R65 ✓ R10

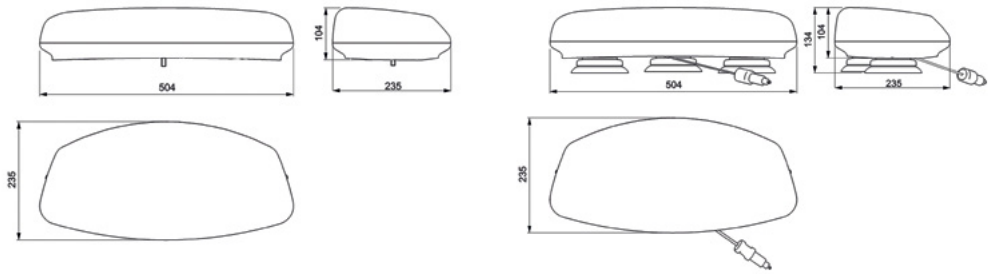

3 Types de flash homologués ECE R65  
3 Flash patterns certified ECE R65  
3 Blitzarten ECE R65 zugelassen



**D14504**  
(23.51.L05.5V8)



**D14505**  
(23.51.LM5.5V8)



**D14506**  
(23.51.811.VLG)

cabochon - lens - Lichtscheibe



## MULTILUX



H1

12/24V

✓ R65 ✓ R10



lampes 12/24V fournies  
- 12/24V bulbs included -  
inklusive Glühlampen 12/24V

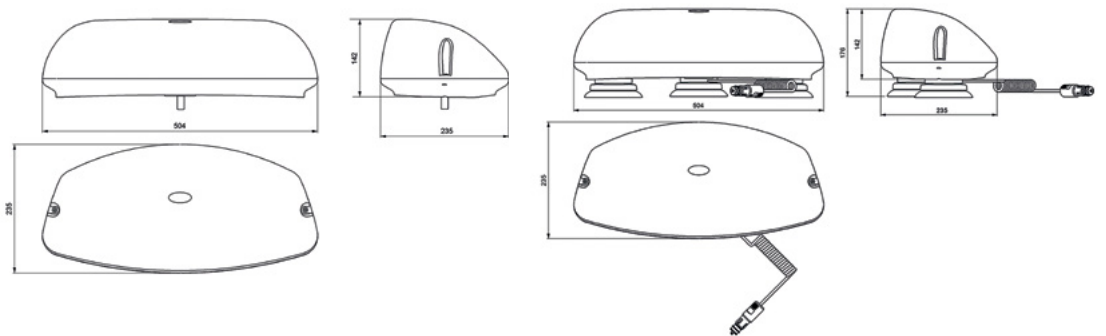

**D14472**  
(2350.03T.PVL)



**D14473**  
(2350.M3T.PVL)



**D14474**  
(2350.811.VLG)

cabochon - lens - Lichtscheibe



# Triflash



LED à éclats  
LED Flash  
Blitze LED



Polycarbonate  
Polycarbonate  
Polycarbonat



Pièces détachées  
Spare parts  
Ersatzteile



Flashez le QR code pour plus d'infos  
Scan the QR code for more info  
Scannen Sie den QR-Code für weitere Informationen



Indice de protection IP - solides/liquides  
IP ingress protection - solids/liquids  
IP Schutzfaktor - Fremdkörper/Wasser



Homologation circulation réseau routier public  
Approval circulation on public road network  
Genehmigung des öffentlichen Straßennetzes



Homologation CEM - compatibilité électromagnétique  
EMC approval - Electromagnetic Compatibility  
EMV zulassung - Elektromagnetische Verträglichkeit

# TRIFLASH 500



LED

10/30V  
9,5 W

R10

PC/ABS

IP6K9K

< 3,5t



\* kit de relevage manuel inclus - manual lift kit included - manueller Aufzug inklusive

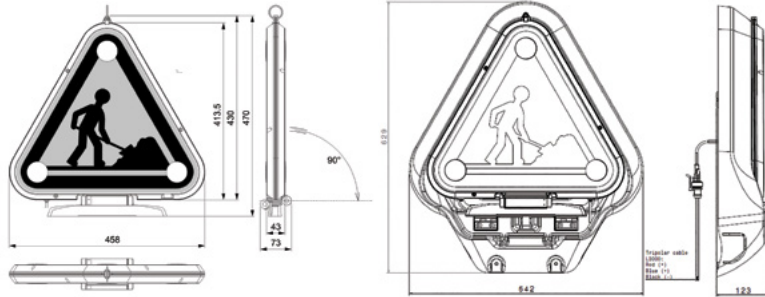

Symbole AK5 - Compact - Léger (3,15 Kg) - Homologué  
AK5 symbol - Compact - Light (3,15 Kg) - Approved  
AK5-Symbol - Kompakt - Leicht (3,15 kg) - Zugelassen



**D14760 \***  
(2090L51200)



Classe 1 : ville et route nationale - town and trunk roads - Stadt und Landstrassen



**D14762 \***  
(2090L52200)



Classe 2 : autoroutes et voies rapides - highways - Autobahnen und Schnellstrassen

**NEW**

ELEC



**D14925**  
(2090L5220E)



Classe 2 : autoroutes et voies rapides - highways - Autobahnen und Schnellstrassen

# TRIFLASH 700



LED

10/30V  
9,5 W

R10

PC/ABS

IP6K9K

> 3,5t



\* kit de relevage manuel inclus - manual lift kit included - manueller Aufzug inklusive

**NEW**



**D14926 \***  
(2090L72200)



Classe 2 : autoroutes et voies rapides - highways - Autobahnen und Schnellstrassen

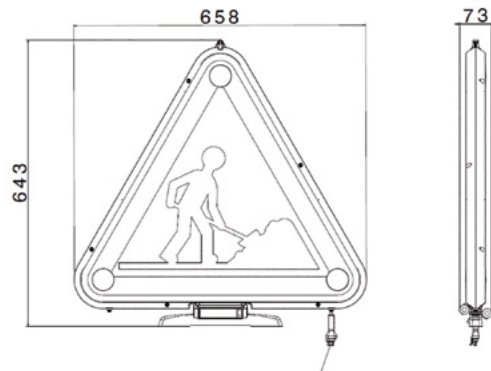

## TRIFLASH ACC



LED

10/30V  
9,5 W

✓ R65 ✓ R10



IP6K9K

Exemple de montage D14762 + D14930  
Assembly suggestion D14762 + D14930  
Montagebeispiel D14762 + D14930



110 cm



**D14932**  
(2090L1B110)

Pour Triflash avec 1 gyrophare LED  
For Triflash with 1 LED beacon  
Für Triflash mit 1 LED rundumkennleuchte

136 cm



**D14933**  
(2090L1B136)

Pour Triflash avec 1 gyrophare LED  
For Triflash with 1 LED beacon  
Für Triflash mit 1 LED rundumkennleuchte

155 cm



**D14934**  
(2090L1B151)

Pour Triflash avec 1 gyrophare LED  
For Triflash with 1 LED beacon  
Für Triflash mit 1 LED rundumkennleuchte

110 cm



**D14929**  
(2090L2B110)

Pour Triflash avec 2 gyrophares LED  
For Triflash with 2 LED beacons  
Für Triflash mit 2 LED rundumkennleuchten

136 cm



**D14930**  
(2090L2B136)

Pour Triflash avec 2 gyrophares LED  
For Triflash with 2 LED beacons  
Für Triflash mit 2 LED rundumkennleuchten

155 cm



**D14931**  
(2090L2B151)

Pour Triflash avec 2 gyrophares LED  
For Triflash with 2 LED beacons  
Für Triflash mit 2 LED rundumkennleuchten

181 cm



**D14935**  
(2090L2B181)

Pour Triflash avec 2 gyrophares LED  
For Triflash with 2 LED beacons  
Für Triflash mit 2 LED rundumkennleuchten



**D14928**  
(2090805000)

Kit de relevage manuel pour -  
manual lift kit for - manuelle  
Aufzug für  
D14760 - D14762 - D14926



**D14922**  
(209080U000)

Support universel - Pattes de  
fixation pour barre Triflash.  
Universal bracket - Mounting  
brackets for Triflash bar  
Universalhalterung - für  
Triflash- Dachträger



**D14989**  
(2090804000)

Kit de fixation sur barre pour  
Triflash électrique D14925.  
Bar mounting kit for electric  
Triflash D14925.  
Stangenmontage-Kit für elek-  
trischen Triflash D14925.

# Feux de pénétration

## Directional lights

### Warnleuchten

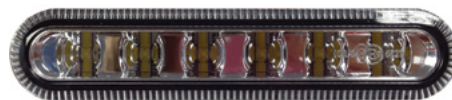
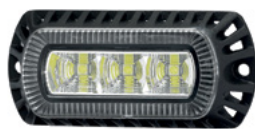

Flashez le QR code pour plus d'infos  
Scan the QR code for more info  
Scannen Sie den QR-Code für weitere Informationen



Indice de protection IP - solides/liquides  
IP ingress protection - solids/liquids  
IP Schutzfaktor - Fremdkörper/Wasser



Pièces détachées  
Spare parts  
Ersatzteile



Homologation circulation réseau routier public  
Approval circulation on public road network  
Genehmigung des öffentlichen Straßennetzes



Homologation CEM - compatibilité électromagnétique  
EMC approval - Electromagnetic Compatibility  
EMV zulassung - Elektromagnetische Verträglichkeit



Polycarbonate  
Polycarbonate  
Polycarbonat



# Feux de pénétration - Directional lights - Warnleuchten

## DL SMALL



LED

10/30V  
9 W

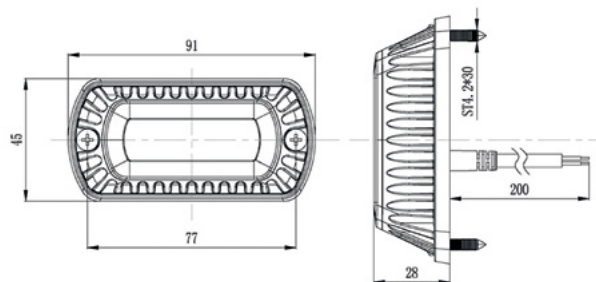
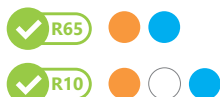

- D13860** ●
- D13863** ○
- D13862** ●

10 types de flash  
10 flash patterns  
10 Blitzmuster

Single (440ms)	Single (1000ms)
Double (480ms)	Triple (930ms)
Quad (725ms)	Penta (850ms)
Double (1000ms)	Triple (750ms)
Quad (610ms)	Penta (800ms)

## DL LONG



LED

10/30V  
12 W

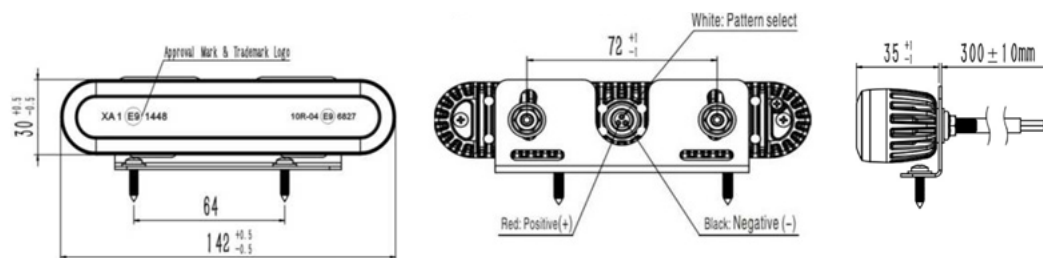
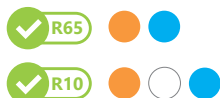

- D14190** ●
- D14354** ○
- D14353** ●

10 types de flash  
10 flash patterns  
10 Blitzmuster

One Flash (600ms)	In turn Double Flash (800ms)
In turn 4 Flash (800ms)	3 Flash (600ms)
5 Flash (1000ms)	1 Flash (960ms)
In turn 3 Flash (600ms)	Unique (410ms)
Frequent Flash (60ms)	Combination



Alternative flash ← →

# Alarmes sonores de recul

## Back-up alarms

### Rückfahrwarner



Standard



Multi-Frequency



Flashez le QR code pour plus d'infos  
Scan the QR code for more info  
Scannen Sie den QR-Code für weitere Informationen



Indice de protection IP - solides/liquides  
IP ingress protection - solids/liquids  
IP Schutzfaktor - Fremdkörper/Wasser



Pièces détachées  
Spare parts  
Ersatzteile



Homologation CEM - compatibilité électromagnétique  
EMC approval - Electromagnetic Compatibility  
EMV zulassung - Elektromagnetische Verträglichkeit

# Alarmes sonores de recul - Back-up alarms - Rückfahrwarner

## ASR



### STANDARD - HERKÖMLICH

101 mm x 67 mm x 41 mm

Standard



1. Chariots élévateurs, petits camions, VUL  
Forklifts, small trucks, LCV  
Gabelstapler, Lieferwagen, Transporter
2. Toute utilisation. Ajustement automatique 10 db supérieur au bruit ambiant  
All use. Automatic adjustment 10dB higher than the environment noise  
Alle Anwendungsbereiche. Automatische Lautstärkeanpassung +10db über Umgebungslärm
3. Benne à ordure, chantier, forêt, PL  
Waste collection vehicles, forest work vehicles, trucks  
Müllfahrzeuge, Baustellenfahrzeuge, Forstfahrzeuge, LKW



12/24V



IP65

1	<b>630120</b>	87 db
2	<b>630110</b>	82-102 db
3	<b>630100</b>	102 db

### MULTI-FRÉQUENCE - MULTI-FREQUENCY - MEHRFACHFREQUENZ

102 mm x 71 mm x 41 mm

Multi-Frequency



<b>D13807</b>	87 db
<b>D13808</b>	97 db

Multi-Frequency



<b>D13810</b>	97 db 1500 mm
---------------	------------------

CLICK-IN



24V

### INTÉGRÉE - BUILT-IN - EINGEBAUT



<b>001830</b>	90 db
---------------	-------

Pour connection sur feu arrière LC8 p. 150  
To plug in LC8 rear lamp p. 150  
Zum direkten Anschluss an die Heckleuchte LC8 S. p. 150



<b>001872</b>	55-90db
---------------	---------

Ajustement bruit ambiant sur feu arrière LC8 MAN p. 153  
Environment noise adjustment MAN LC8 rear lamp p. 153  
Automatische Umgebungslärm Heckleuchte MAN LC8 S. p. 153



<b>D12953</b>	90 db
---------------	-------

Pour connection sur feu arrière LC9 p. 160, LC7 p. 166  
To plug in LC9 / LC7 rear lamp p. 160 / p. 166  
Zum direkten Anschluss an die Heckleuchte LC9 S. p. 160, LC7 S. p. 166

# Systèmes caméra

## Camera systems

### Kamera-Systeme

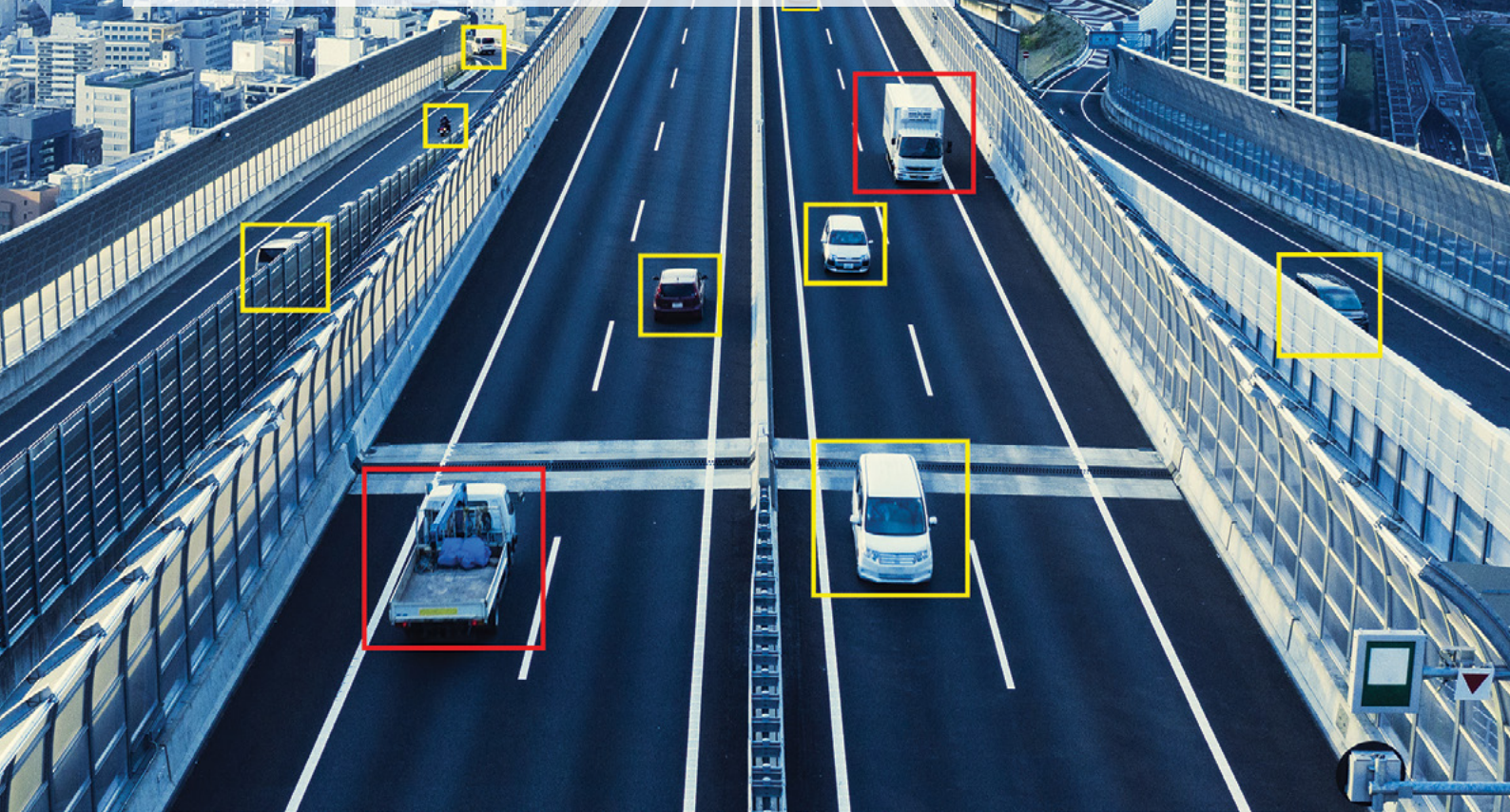

## Systèmes sans fil - Wireless Systems - Drahtlose systeme

p. 276-280



## Systèmes filaires - Wired systems - Verdrahtete systeme

p. 281-290



Flashez le QR code pour plus d'infos  
Scan the QR code for more info  
Scannen Sie den QR-Code für weitere Informationen



Système HD  
HD system  
HD systeme



Indice de protection IP - solides/liquides  
IP ingress protection - solids/liquids  
IP Schutzfaktor - Fremdkörper/Wasser



Écran tactile  
Touch screen  
Berührungsbildschirm



Pièces détachées  
Spare parts  
Ersatzteile



Caméra vision nocturne  
Night vision camera  
Nachtsichtkamera



Taille écran  
Screen size  
Bildschirmgröße



Écran fractionné  
Split screen  
geteilter Bildschirm



Système sans fil  
Wireless system  
Drahtlose systeme

## CAM WIRELESS 2.4 GHz



### D14328

12/24V - Ecran fractionné couleur 7 pouces - transmission sans fil 2.4 GHz - Raccordement jusqu'à 4 caméras - **appairage automatique** - Enregistrement en temps réel - Support carte micro SD (non fournie) - Caméra micro intégré - vision de nuit - Utilisation entre -20°C et +70°C

12/24V - 7 inch colour quad screen - Wireless transmission 2.4 GHz - connecting up to 4 wireless cameras - **Auto scan** - Real time recording - Support SD card - Camera with micro integrated - night vision - Use between -20°C and +70°C

12/24V - 7" Farbbildschirm - Übertragungsfrequenz 2,4 GHz - bis zu 4 drahtlose Kameras anschließbar - **Automatischer Abgleich** - Echtzeit-aufnahme - SD Karten Aufnahme - Nachtsichtkamera mit integriertem Mikrofon - Betriebstemperatur -20°C bis +70°C



### TEMPS D'ENREGISTREMENT - RECORDING TIME - AUFNAHMEZEIT :

MODE \ Micro SD	8G	16G	32G	64G	128G
SINGLE (640x480x1)	14h	28h	55h	110h	220h
QUAD (320x240x4)	11h	22h	43h	86h	172h
SPLIT (400x480x2)	13h	25h	50h	101h	201h

### NOTICE DE BRANCHEMENT - CONNECTION INSTRUCTIONS - ANSCHLUSSANWEISUNGEN :



rouge positif - red positive - rot positiv  
 noir masse - black ground - schwarz Erdung  
 marron recul - brown reverse - Braun Zurückfahren  
 blanc clignotant gauche - white left indicator - Weiß Blinker links  
 bleu clignotant droit - blue right indicator - Blau Blinker rechts  
 vert ou jaune option - green or yellow trigger option - grüne oder gelbe Triggeroption



Les appareils 2.4 GHz tels que les téléphones cellulaires, les systèmes Bluetooth et Wi-Fi peuvent causer des interférences passagères. 2.4 GHz devices such as mobile phones, Bluetooth and Wi-Fi may cause some temporary interferences. Bei gleichzeitigem Betrieb von Geräten, die im Frequenzbereich von 2,4 GHz arbeiten, wie z.B. Mobiltelefone, Bluetooth und WLAN Übertragungen, können gelegentlich Störinterferenzen auftreten.



COMPOSEZ VOTRE KIT SUR-MESURE  
 BUILD YOUR OWN CUSTOM KIT  
 STELLEN SIE SICH IHR KIT MASSGESCHNEIDERT ZUSAMMEN

### 1. ECRAN - MONITOR - FARBBILDSCHIRM



**D14216**

Ecran 7" - 7" screen - 7" Farbbildschirm  
 Fractionnable - Multi display - Teilbar

### 2. CAMÉRA - CAMERA - KAMERA



**D14236**

**NEW**



**D14906**

**NEW**



**D14882**

batterie rechargeable  
 rechargeable battery  
 Akku

### 3. ACCESSOIRES - ACCESSORIES - ZUBEHÖR



**D14063**

7 m



**D14326**

antenne écran - screen antenna  
 - Bildschirmantenne



**D14195**

antenne caméra - camera  
 antenna - Kameraantenne



**D14347**

10/32V

Batterie mobile - 10-12h autonomie  
 Mobile battery - 10-12h autonomy  
 Mobilbatterie - 10-12h autonomie



Exemple de montage - Assembly suggestion - Montage-  
 beispiel  
 Kit D14328 + D14236 x 3

## CAM WIRELESS HD 2.4 GHz



**NEW**



**D14805**

12/24V - Image HD 720P - Ecran fractionné couleur 7 pouces - transmission sans fil 2.4 GHz - Raccordement jusqu'à 4 caméras - **appairage automatique** - Enregistrement en temps réel - Support carte micro SD (non fournie) - Caméra micro intégré - vision de nuit - Utilisation entre -20°C et +70°C

12/24V - HD 720P image - 7 inch colour quad screen - Wireless transmission 2.4 GHz - connecting up to 4 wireless cameras - **Auto scan** - **Real time recording** - **Support SD card** - Camera with micro integrated - night vision - Use between -20°C and +70°C

12/24V - HD 720P-Bild - 7" Farbbildschirm - Übertragungsfrequenz 2,4 GHz - bis zu 4 drahtlose Kameras anschließbar - **Automatischer Abgleich** - **Echtzeitaufnahme** - **SD Karten Aufnahme** - Nachtsichtkamera mit integriertem Mikrofon - Betriebstemperatur -20°C bis +70°C



### TEMPS D'ENREGISTREMENT - RECORDING TIME - AUFNAHMEZEIT :

MODE \ Micro SD	8G	16G	32G	64G	128G
SINGLE (640x480x1)	14h	28h	55h	110h	220h
QUAD (320x240x4)	11h	22h	43h	86h	172h
SPLIT (400x480x2)	13h	25h	50h	101h	201h

### NOTICE DE BRANCHEMENT - CONNECTION INSTRUCTIONS - ANSCHLUSSANWEISUNGEN :



rouge positif - red positive - rot positiv  
 noir masse - black ground - schwarz Erdung  
 marron recul - brown reverse - Braun Zurückfahren  
 blanc clignotant gauche - white left indicator - Weiß Blinker links  
 bleu clignotant droit - blue right indicator - Blau Blinker rechts  
 vert ou jaune option - green or yellow trigger option - grüne oder gelbe Triggeroption



Les appareils 2.4 GHz tels que les téléphones cellulaires, les systèmes Bluetooth et Wi-Fi peuvent causer des interférences passagères. 2.4 GHz devices such as mobile phones, Bluetooth and Wi-Fi may cause some temporary interferences. Bei gleichzeitigem Betrieb von Geräten, die im Frequenzbereich von 2,4 GHz arbeiten, wie z.B. Mobiltelefone, Bluetooth und WLAN Übertragungen, können gelegentlich Störinterferenzen auftreten.

## ACC WIRELESS HD 720P



12/24V



COMPOSEZ VOTRE KIT SUR-MESURE  
BUILD YOUR OWN CUSTOM KIT  
STELLEN SIE SICH IHR KIT MASSGESCHNEIDERT ZUSAMMEN

### 1. ECRAN - MONITOR - FARBBILDSCHIRM

**NEW**



**D14803**

Ecran 7" - 7" screen - 7" Farbbildschirm  
Fractionnable - Multi display - Teilbar

### 2. CAMÉRA - CAMERA - KAMERA

**NEW**

∠110°



**D14804**

**NEW**

∠110°



**D14905**

capot motorisé - auto-shutter -  
motorisierter Decke



### 3. ACCESSOIRES - ACCESSORIES - ZUBEHÖR



**D14326**

antenne écran - screen antenna  
- Bildschirmantenne



**D14195**

antenne caméra - camera  
antenna - Kameraantenne



**D14347**

10/32V

Batterie mobile - 10-12h autonomie  
Mobile battery - 10-12h autonomy  
Mobilbatterie - 10-12h autonomie



## CAM WIFI



∠110°

**NEW**



**D14806**



Magnétique et sur batterie rechargeable, l'installation est rapide et simple. Après avoir téléchargé l'application sur votre **smartphone** ou tablette (voir notice), vous pouvez regarder en temps réel la vidéo par wifi mais aussi faire des captures d'écran. Câble de rechargement USB fourni.



Magnétique et sur batterie rechargeable, l'installation est rapide et simple. Après avoir téléchargé l'application sur votre **smartphone** ou tablette (voir notice), vous pouvez regarder en temps réel la vidéo par wifi mais aussi faire des captures d'écran. Câble de rechargement USB fourni.

Magnetisch und auf wiederaufladbarer Batterie, die Installation ist schnell und einfach. Nach dem Herunterladen der App auf Ihr **Smartphone** oder Tablet (siehe Anleitung) können Sie sich das Video in Echtzeit über Wifi ansehen, aber auch Screenshots machen. USB-Ladekabel enthalten.



RECOMMANDÉ IOS + ANDROID  
RECOMMENDED IOS + ANDROID  
EMPFOHLEN IOS + ANDROID



## CAM WIRED



ENVIRONNEMENT SEVERE  
HARSH ENVIRONMENT  
EXTREME UMWELTBEDINGUNGEN

∠120°



20 m

**NEW**

### D14091

12/24V - Ecran couleur 7 pouces - Raccordement possible pour 1 caméra - Caméra LED en aluminium/inox micro intégré - vision de nuit - Utilisation entre -40°C et +70°C

12/24V - 7 inch colour screen - Connection possible for 1 camera - LED aluminium/stainless steel camera with micro integrated - night vision - Use between -40°C and +70°C

12/24V - 7" Farbbildschirm - bis zu 1 Kamera anschließbar - LED - Nachtsichtkamera aus Aluminium/Edelstahl mit integriertem Mikrofon - Betriebstemperatur -40°C bis +70°C



## CAM WIRED

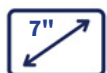

∠ 120°



20 m

**NEW**

### D14915

12/24V - Ecran couleur 7 pouces - Raccordement possible pour 1 caméra - Caméra LED CMOS micro intégré - vision de nuit - Utilisation entre -40°C et +70°C

12/24V - 7 inch colour screen - Connection possible for 1 camera - LED CMOS camera with micro integrated - night vision - Use between -40°C and +70°C

12/24V - 7" Farbbildschirm - bis zu 1 Kamera anschließbar - LED - Nachtsichtkamera CMOS mit integriertem Mikrofon - Betriebstemperatur -40°C bis +70°C



## CAM WIRED

NOTICE DE BRANCHEMENT D14091 - D14915 - CONNECTION INSTRUCTIONS - ANSCHLUSSANWEISUNGEN :



rouge positif - red positive - rot positiv  
 noir masse - black ground - schwarz Erdung  
 Fil marron recul - brown wire reverse - Braun-Draht Zurückfahren  
 connecteur marron caméra - brown connector camera - Braun-anschluss Kamera

## ACC WIRED



COMPOSEZ VOTRE KIT SUR-MESURE

BUILD YOUR OWN CUSTOM KIT

STELLEN SIE SICH IHR KIT MASSGESCHNEIDERT ZUSAMMEN



12/24V

### 1. ECRAN - MONITOR - FARBBILDSCHIRM

**NEW**



**D14916**

Ecran 7" - 7" screen - 7" Farbbildschirm  
 Pour 1 caméra - For 1 camera - Für 1 Kamera



### 2. CAMÉRA - CAMERA - KAMERA



12/24V

∠120°



**D13617**

∠120°



**D13881**

Aluminium/Inox - Aluminum / Stainless steel - Aluminium / Edelstahl

∠150°



**D14148**

Slim grand angle  
 Slim wide angle  
 Slim 150° winkel

∠120°



**D14327**

Motorisée + chauffante  
 Motorized + auto heater  
 Motorisierte + Heizung

## ACC WIRED



### 2. CAMÉRA - CAMERA - KAMERA

∠150°

**NEW**



**D14808**

Top view grand angle  
Top view wide angle  
Top view 150° winkel



∠150°

**NEW**



**D14807**

Top view grand angle  
Top view wide angle  
Top view 150° winkel

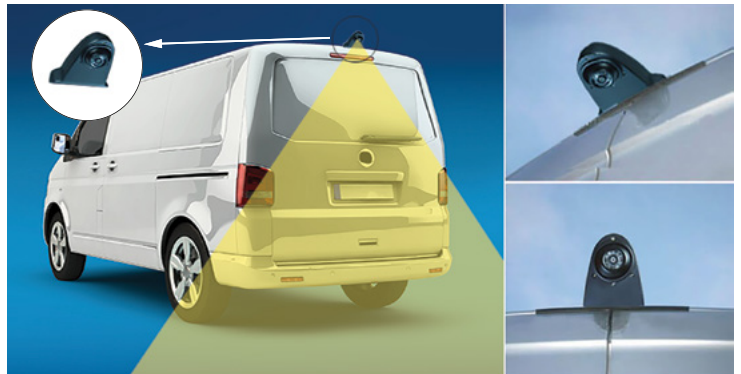

### 3. CÂBLAGE - WIRING - VERKABELUNG



**D13620**



**D13621**

10 m

**D13622**

20 m



### EXEMPLES DE MONTAGE - ASSEMBLY SUGGESTION - MONTAGEBEISPIEL



## CAM WIRED HD 720P



ENVIRONNEMENT SEVERE  
HARSH ENVIRONMENT  
EXTREME UMWELTBEDINGUNGEN



∠110°



20 m

**NEW**

### D14904



12/24V - Qualité d'image HD 720P - Ecran couleur 7 pouces - Raccordement jusqu'à 3 caméras - Caméra LED en inox micro intégré - vision de nuit - Utilisation entre -20°C et +70°C

12/24V - 720P HD image quality - 7 inch colour screen - Connecting up to 3 cameras - LED stainless steel camera with micro integrated - night vision - Use between -20°C and +70°C

12/24V - 720P HD-Bildqualität - 7" Farbbildschirm - bis zu 3 Kameras anschließbar - LED - Nachtsichtkamera aus Edelstahl mit integriertem Mikrofon - Betriebstemperatur -20°C bis +70°C

## CAM WIRED HD 720P



∠110°



20 m

**NEW**

### D14903



12/24V - Qualité d'image HD 720P - Ecran couleur 7 pouces - Raccordement jusqu'à 3 caméras - Caméra LED en aluminium micro intégré - vision de nuit - Utilisation entre -20°C et +70°C

12/24V - 720P HD image quality - 7 inch colour screen - Connecting up to 3 cameras - LED aluminum camera with micro integrated - night vision - Use between -20°C and +70°C

12/24V - 720P HD-Bildqualität - 7" Farbbildschirm - bis zu 3 Kameras anschließbar - LED - Nachtsichtkamera aus Aluminium mit integriertem Mikrofon - Betriebstemperatur -20°C bis +70°C

## CAM WIRED HD 720P

NOTICE DE BRANCHEMENT D14904 - D14903 - CONNECTION INSTRUCTIONS - ANSCHLUSSANWEISUNGEN :



## ACC WIRED HD 720P



COMPOSEZ VOTRE KIT SUR-MESURE

BUILD YOUR OWN CUSTOM KIT

STELLEN SIE SICH IHR KIT MASSGESCHNEIDERT ZUSAMMEN



12/24V

### 1. ECRAN - MONITOR - FARBBILDSCHIRM

### 2. CAMÉRA - CAMERA - KAMERA

**NEW**



**D14901**

Ecran 7" - 7" screen - 7" Farbbildschirm  
 Pour 3 caméras - For 3 cameras - Für 3 Kameras

∠110°



**D14900**

Aluminium - Aluminum - Alu-  
 minium

∠110°



**D14902**

Inox - Stainless steel - Edelstahl



### 3. CÂBLAGE - WIRING - VERKABELUNG



**D13620**

Pour 1 caméra HD720P - For 1  
 HD 720P camera - Für 1 HD720P  
 Kamera



**D14685**

Pour 2 caméras HD - For 2 HD  
 cameras - Für 2 HD Kameras



**D13621**

10 m

**D13622**

20 m

## CAM WIRED HD 1080P



### D14677

12/24V - Qualité d'image HD 1080P - Ecran couleur 7 pouces tactile - Raccordement jusqu'à 3 caméras - Design épuré

12/24V - 1080P HD image quality - 7 inch colour touch screen - Connecting up to 3 cameras - Sleek design

12/24V - 1080P HD-Bildqualität - 7" Berührungsempfindlicher Farbbildschirm - bis zu 3 Kameras anschließbar - Glatt Design



## CAM WIRED HD 1080P



### D14680

12/24V - Qualité d'image HD 1080P - Ecran couleur 10 pouces tactile - Raccordement jusqu'à 3 caméras - Design épuré

12/24V - 1080P HD image quality - 10 inch colour touch screen - Connecting up to 3 cameras - Sleek design

12/24V - 1080P HD-Bildqualität - 10" Berührungsempfindlicher Farbbildschirm - bis zu 3 Kameras anschließbar - Glatt Design



## CAM WIRED HD 720P

### NOTICE DE BRANCHEMENT D14677 - D14680 - CONNECTION INSTRUCTIONS - ANSCHLUSSANWEISUNGEN :



Exemple de montage - Assembly suggestion - Montagebeispiel  
 Kit D14677 + D13621 + D13685



## ACC WIRED HD 1080P



COMPOSEZ VOTRE KIT SUR-MESURE

BUILD YOUR OWN CUSTOM KIT

STELLEN SIE SICH IHR KIT MASSGESCHNEIDERT ZUSAMMEN



12/24V

HD  
1080P



### 1. ECRAN - MONITOR - FARBBILDSCHIRM



**D14678**

Ecran mono HD 7" - 7" mono HD screen - 7" Mono HD-Farbbildschirm



**D14681**

Ecran mono HD 10" - 10" mono HD screen - 10" Mono HD-Farbbildschirm



**D14683**

Ecran quad HD 7" fractionnable - 7" quad HD screen Multi display - 7" Quad HD-Farbbildschirm Teilbar



**D14684**

Ecran quad HD 10" fractionnable - 10" quad HD screen Multi display - 10" Quad HD-Farbbildschirm Teilbar

### NOTICE DE BRANCHEMENT D14683 - D14684 - CONNECTION INSTRUCTIONS - ANSCHLUSSANWEISUNGEN :



rouge positif - red positive - rot positiv  
noir masse - black ground - schwarz Erdung  
fil blanc positif Cam1 - white wire positive Cam1 - Weiß-Draht positiv Kam1  
fil bleu positif Cam2 - blue wire positive Cam2 - Blau-Draht positiv Kam2  
fil vert positif Cam3 - green wire positive Cam3 - Grün-Draht positiv Kam3  
fil marron positif Cam4 - brown wire positive Cam4 - Braun-Draht positiv Kam4  
fil jaune activation écran fractionné - yellow wire split trigger - Aktivierung des Split-Bildschirms mit gelbem Draht  
connecteur blanc Cam1 - white connector Cam1 - Weiß-anschluss Kam1  
connecteur bleu Cam2 - blue connector Cam2 - Blau-anschluss Kam2  
connecteur vert Cam3 - green connector Cam3 - Grün-anschluss Kam3  
connecteur marron Cam4 - brown connector Cam4 - Braun-anschluss Kam4

### 2. CAMÉRA - CAMERA - KAMERA

∠130°



**D14679**

Aluminium - Aluminum - Aluminium HD 1080P

∠130°



**D14682**

Inox - Stainless steel - Edelstahl HD 1080P

### 3. CÂBLAGE - WIRING - VERKABELUNG



**D14685**

Pour 2 caméras HD720P - For 2 HD 720P cameras - Für 2 HD720P Kameras



**D13621**

10 m

**D13622**

20 m



Exemple de montage - Assembly suggestion - Montagebeispiel

## CAM 360° HD 1080P



∠190°



**NEW**

### D14859

12/24V - Qualité d'image HD 1080P - 1 boîtier de contrôle + 4 caméras HD 1080P extra grand angle 190°. Écran non inclus.

12/24V - 1080P HD image quality - 1 control box + 4 HD 1080P 190° extra wide angle cameras. Monitor not included.

12/24V - 1080P HD-Bildqualität - 1 Steuerkasten + 4 HD 1080P Extraweitwinkel 190° Kameras. Bildschirm nicht enthalten.



### D14678

Ecran mono HD 7" - 7" mono HD screen - 7" Mono HD-Farbbildschirm



### D14681

Ecran mono HD 10" - 10" mono HD screen - 10" Mono HD-Farbbildschirm



### D14683

Ecran quad HD 7" fractionnable - 7" quad HD screen Multi display - 7" Quad HD-Farbbildschirm Teilbar



### D14684

Ecran quad HD 10" fractionnable - 10" quad HD screen Multi display - 10" Quad HD-Farbbildschirm Teilbar

**NEW**



### D14901

Ecran 7" - 7" screen - 7" Farbbildschirm  
Pour 3 caméras - For 3 cameras - Für 3 Kameras



## CAM WIRED DETECTION



**NEW**  $\angle 140^\circ$

ALERTE AUDIO  
AUDIO ALERT  
AUDIO-ALARM

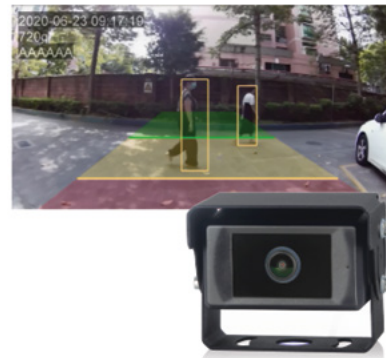

**D14995**

12/24V - Qualité d'image HD 1080P - Détection de piétons et cyclistes 0,5 - 12 m

12/24V - 1080P HD image quality - Pedestrian and cyclist detection 0,5 - 12 m

12/24V - 1080P HD-Bildqualität - Fußgänger- und Radfahrerererkennung 0,5 - 12 m



**D14678**

Ecran mono HD 7" - 7" mono  
HD screen - 7" Mono HD-Farb-  
bildschirm



**D14681**

Ecran mono HD 10" - 10" mono  
HD screen - 10" Mono HD-Farb-  
bildschirm



**D13621**

10 m

**D13622**

20 m

## CAM WIRED MIRRORS



**NEW**

**NEW**



**D14955**

Ecran miroir HD 12,3" - 12,3" mirror HD  
screen - 12,3" Mono HD-Spiegelbildschirm



**D14956**

# Coffres porte extincteur

Extinguisher boxes

Feuerlöscherbehälter



Flashez le QR code pour plus d'infos  
Scan the QR code for more info  
Scannen Sie den QR-Code für weitere Informationen

# Coffres porte extincteur - Extinguisher boxes - Feuerlöscherbehälter

## 5054

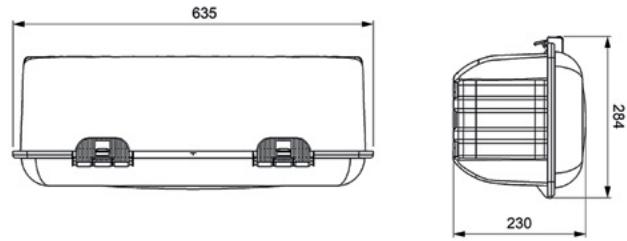

Max 6 kg

**D14538**  
(50.52.925.TV2)

Avec sangle nylon - with nylon strap - mit nylon Riemen



Max 6 kg

**D14539**  
(50.52.925.TVC)

Avec sangle CLIP réglable - with adjustable CLIP strap - mit verstellbaren Riemen CLIP

## 5051

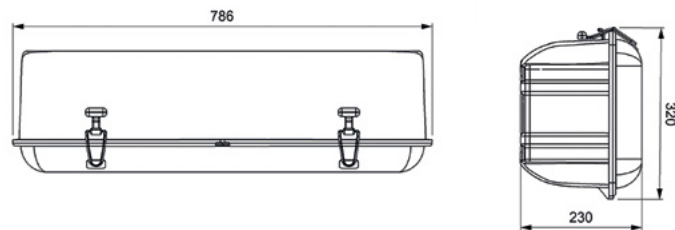

Max 9 kg

**D14537**  
(50.51.020.VLG)

Avec sangle plastique - with plastic strap - mit Kunststoff Riemen

# Prises et câbles spiralés

## Plugs and coils

## Stecker und Spiralkabel



**NEW**



**NEW**



Flashez le QR code pour plus d'infos  
Scan the QR code for more info  
Scannen Sie den QR-Code für weitere Informationen

## 7P



24V

24N (ISO 1185)  
24S (ISO 3731)

### MÉTALLIQUE - METAL - METALL



**D10873**

24N

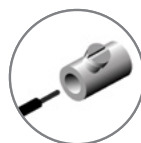

**611530**

24N



**D10874**

24S



**611550**

24S

### PLASTIQUE - PLASTIC - KUNSTSTOFF



**611500**

24N

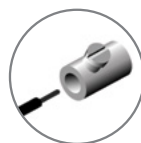

**611580**

24N



**611510**

24S



**611590**

24S



**611520**

24N



**611540**

24S

## C7P



Longueur de travail : L  
Working length : L  
Arbeitslänge : L

LMax  
Longueur d'extension maximale  
Maximum extension length  
Maximale Ausziehlänge

### MÉTALLIQUE - METAL - METALL



**D14313** LMax 3,5 m **24N**

**611140** L : 3 m, LMax 4,5 m



**D14314** LMax 3,5 m **24S**

**611150** L : 3 m, LMax 4,5 m

### PLASTIQUE - PLASTIC - KUNSTSTOFF



**D14312** LMax 3,5 m **24N**

**611070** L : 3 m, LMax 4,5 m



**D14316** LMax 3,5 m **24S**

**611080** L : 3 m, LMax 4,5 m

EURO6

**D14574** L : 3 m, LMax 4,5 m

**D14575** L : 3 m, LMax 4,5 m

EURO6

6 x 1,0 mm<sup>2</sup> + 1 x 1,5 mm<sup>2</sup>



**611110** **24N/24S**

24N

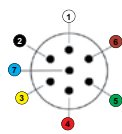

- ① - Masse
- ② - Feu de position G
- ③ - Clignotant G
- ④ - Feu Stop
- ⑤ - Clignotant D
- ⑥ - Feu de position D,
- ⑦ - Commande de frein

- Common return
- L rear position lamp
- L flasher lamp
- Stop lamp
- R flasher lamp
- R rear position lamp,
- Breaking control

- Masse
- Linke Schlussleuchte
- Fahrrichtungsanzeiger links
- Bremsleuchte
- Fahrrichtungsanzeiger rechts
- Rechte Schlussleuchte
- Steuerung Anhängerbremse

24S

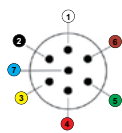

- ① - Masse
- ② - Sans affectation
- ③ - Feu de recul
- ④ - Alimentation en puissance
- ⑤ - Sans affectation
- ⑥ - Sans affectation
- ⑦ - Feu AR de brouillard

- Common return
- Without affectation
- Reverse lamp
- Power supply
- Without affectation
- Without affectation
- Fog lamp

- Masse
- Nicht belegt
- Rückfahrleuchte
- Stromversorgung (Dauerplus)
- Nicht belegt
- Nicht belegt
- Nebelschlussleuchte



# Prises et câbles spiralés - Plugs and coils - Stecker und Spiralkabel

## 15P



24V

ISO 12098



**A10060**

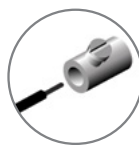

**A10061**



**D14315** LMax 3,5 m

**D11578** L : 3 m, LMax 4,5 m

**D14577** L : 3 m, LMax 4,5 m **EURO6**

## 7P-15P



24V



**D11487** L : 3 m, LMax 4,5 m

**NEW D14824** LMax 3,5 m



**D14689** L : 3 m, LMax 4,5 m

**EURO6 D14578** L : 3 m, LMax 4,5 m

**NEW D14802** LMax 3,5 m



**611410**



**D13889**



**A10064**

## ABS/EBS



ISO 7638-1



**611560** ABS/EBS



**A10062** ABS/EBS



**A10065** ABS/EBS

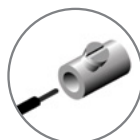

**A10066** ABS/EBS



**D14311** LMax 3,5 m ABS/EBS 7P

**D10597** L : 3 m, LMax 4,5 m ABS/EBS 7P

**D14576** L : 3 m, LMax 4,5 m ABS/EBS 7P **EURO6**



**611570** PARC ABS/EBS-15P

### ABS/EBS



- |   |                    |                    |
|---|--------------------|--------------------|
| ① - Plus (+) alimentation électrovanne  | Plus electrovalve  | Plus Magnetventil  |
| ② - Plus (+) connexions électroniques   | Plus electronics   | Plus Elektronik    |
| ③ - Moins (-) connexions électroniques  | Minus electronics  | Minus Elektronik   |
| ④ - Moins (-) alimentation électrovanne | Minus electrovalve | Minus Magnetventil |
| ⑤ - Connexion lampe témoin              | Warning device     | Warnrichtung       |
| ⑥ - Connexion donnée CANH               | CANH               | Datenleitung CANH  |
| ⑦ - Connexion donnée CANL               | CANL               | Datenleitung CANL  |

### 15 PÔLES



- |                                      |                            |   |
|--------------------------------------|----------------------------|---|
| ① - Clignotant gauche                | L flasher lamp             | Fahrtrichtungsanzeiger links            |
| ② - Clignotant droit                 | R flasher lamp             | Fahrtrichtungsanzeiger rechts           |
| ③ - Feu AR de brouillard             | Fog lamp                   | Nebelschlussleuchte                     |
| ④ - Masse                            | Common return              | Masse                                   |
| ⑤ - Feu de position gauche           | L rear position lamp       | Linke Schlussleuchte                    |
| ⑥ - Feu de position droit            | R rear position lamp       | Rechte Schlussleuchte                   |
| ⑦ - Feu stop                         | Stop lamp                  | Bremsleuchte                            |
| ⑧ - Feu de recul                     | Reverse lamp               | Rückfahrleuchte                         |
| ⑨ - Alimentation 24V                 | 24V power supply           | Stromversorgung +24V                    |
| ⑩ - Capteur d'usure des freins       | Worn brake indicator       | Sensor für Bremsbelagverschleissanzeige |
| ⑪ - Capteurs de pressions des freins | Brake pressure collector   | Anzeige für Federspeicherbremse         |
| ⑫ - Dispositif de levage d'essieu    | Adjustable suspension lift | Achsanhebung                            |
| ⑬ - Masse pour contacts 14 et 15     | Common return              | Masse für Datenleitungen                |
| ⑭ - Bus de données                   | Data line                  | Datenleitung                            |
| ⑮ - Bus de données                   | Data line                  | Datenleitung                            |

## 9P ISOBUS IBBC



12V

ISO 11783-2

**NEW**



**D14942**



**D14943**

4P-IBBC



**D14944**

TBC



**D14945** 6 mm<sup>2</sup>

**D14947** 10 mm<sup>2</sup>

**D14948** 16 mm<sup>2</sup>



**D14949** 6 mm<sup>2</sup> - cable 5 m

**D14950** 10 mm<sup>2</sup> - cable 5 m

**D14951** 10 mm<sup>2</sup> - cable 10 m



# Connecteurs Connectors Anschlussstecker



Flashez le QR code pour plus d'infos  
Scan the QR code for more info  
Scannen Sie den QR-Code für weitere Informationen

AMP 1.5-7P-M

Type connecteur - Nb pins - Mâle ou Femelle  
Connector type - Pins Nb - Male or Female  
Steckertyp - Stifte Nb - männlich oder weiblich

# Connecteurs - Connectors - Anschlussstecker

## AMP 1.5



**D11868** AMP 1.5-7P-F

Connecteur AMP 1.5 simple  
Single AMP 1.5 connector  
Anschlussstecker AMP 1.5

Pour / For / Für  
LC5, LC7, LC8, LC9, LC12, LC11, LC10



## HDSCS



**D13878** HDSCS-8P-F

Connecteur HDSCS simple  
Single HDSCS connector  
Anschlussstecker HDSCS

Pour / For / Für  
LC8, LC11



## JPT



**D13876** JPT-2P-F

Connecteur JPT 2 voies  
2 poles JPT connector  
Anschlussstecker 2 polig JPT

Pour / For / Für  
EPP98, SMD98,  
FPL93, FE98



**D13877** JPT-3P-F

Connecteur JPT 3 voies  
3 poles JPT connector  
Anschlussstecker 3 polig JPT

Pour / For / Für  
ICDL94



## POS



**D13879** POS-2P-F

Connecteur 2 voies position femelle  
2 pin female connector  
Weiblich Anschlussstecker 2 polig

Pour / For / Für  
LC8T, DX



**D14214** POS-2P-M

Connecteur 2 voies position mâle  
2 poles male connector  
Männlich Anschlussstecker 2 polig

## SUPERSEAL



**D13880**

**SS-2P-F**

Connecteur SUPERSEAL 2 voies femelle  
2 poles female SUPERSEAL connector  
Weiblich Anschlussstecker 2 polig

Pour / For / Für  
SMD98, FPL93, LC12, IC DL10,  
LPL18



**D14208**

**SS-2P-M**

Connecteur SUPERSEAL 2 voies mâle  
2 poles male SUPERSEAL connector  
Männlich Anschlussstecker 2 polig



**D14362**

**SS-3P-F**

Connecteur SUPERSEAL 3 voies femelle  
3 poles female SUPERSEAL connector  
Weiblich Anschlussstecker 3 polig

Pour / For / Für  
SMCU

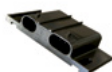

**D14331**

**SS-3P-M**

Connecteur SUPERSEAL 3 voies mâle  
3 poles male SUPERSEAL connector  
Männlich Anschlussstecker 3 polig

## DT



**D14170**

**DT-2P-F**

connecteur 2 voies DT  
2 poles DT connector  
Anschlussstecker 3 polig DT

Pour / For / Für  
feux de travail, work lights,  
Arbeitsscheinwerfer

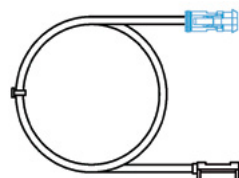

**R12486**

1500 mm

câble adaptateur DT 2V-CLICK-IN  
adapter cable DT 2V-CLICK-IN  
Adapterkabel DT 2V-CLICK-IN

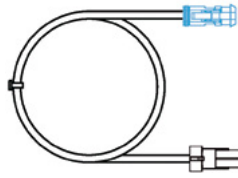

**R14413**

1500 mm

câble adaptateur DT-SUPERSEAL  
adapter cable DT-SUPERSEAL  
Adapterkabel DT-SUPERSEAL



**D14436** **DT06-4S-4P-F**  
 connecteur 4 voies DT06-4S femelle  
 4 poles DT06-4S femaleconnector  
 Weiblich Ansschlussstecker 4 polig DT06-4S



Pour / For / Für  
 CTL15, BL15



**D14434** **DT04-4P-M**  
 connecteur 4 voies DT04-4P mâle  
 4 poles DT04-4P male connector  
 Männlich Ansschlussstecker 4 polig DT04-4P



**D14437** **DTM06-4S-4P-F**  
 connecteur 4 voies DTM06-4S femelle  
 4 poles DTM06-4S femaleconnector  
 Weiblich Ansschlussstecker 4 polig DTM06-4S

Pour / For / Für  
 CTL15, BL15



**D14435** **DTM04-4P-M**  
 connecteur 4 voies DTM04-4P mâle  
 4 poles DTM04-4P male connector  
 Männlich Ansschlussstecker 4 polig DTM04-4P



**D14352** **DT-6P-M**  
 connecteur 6 voies DT  
 6 poles DT connector  
 Ansschlussstecker 6 polig DT

Pour / For / Für  
 CHL



# Faisceaux Harnesses Kabelsatz

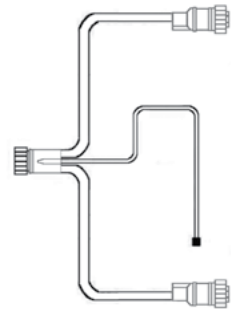
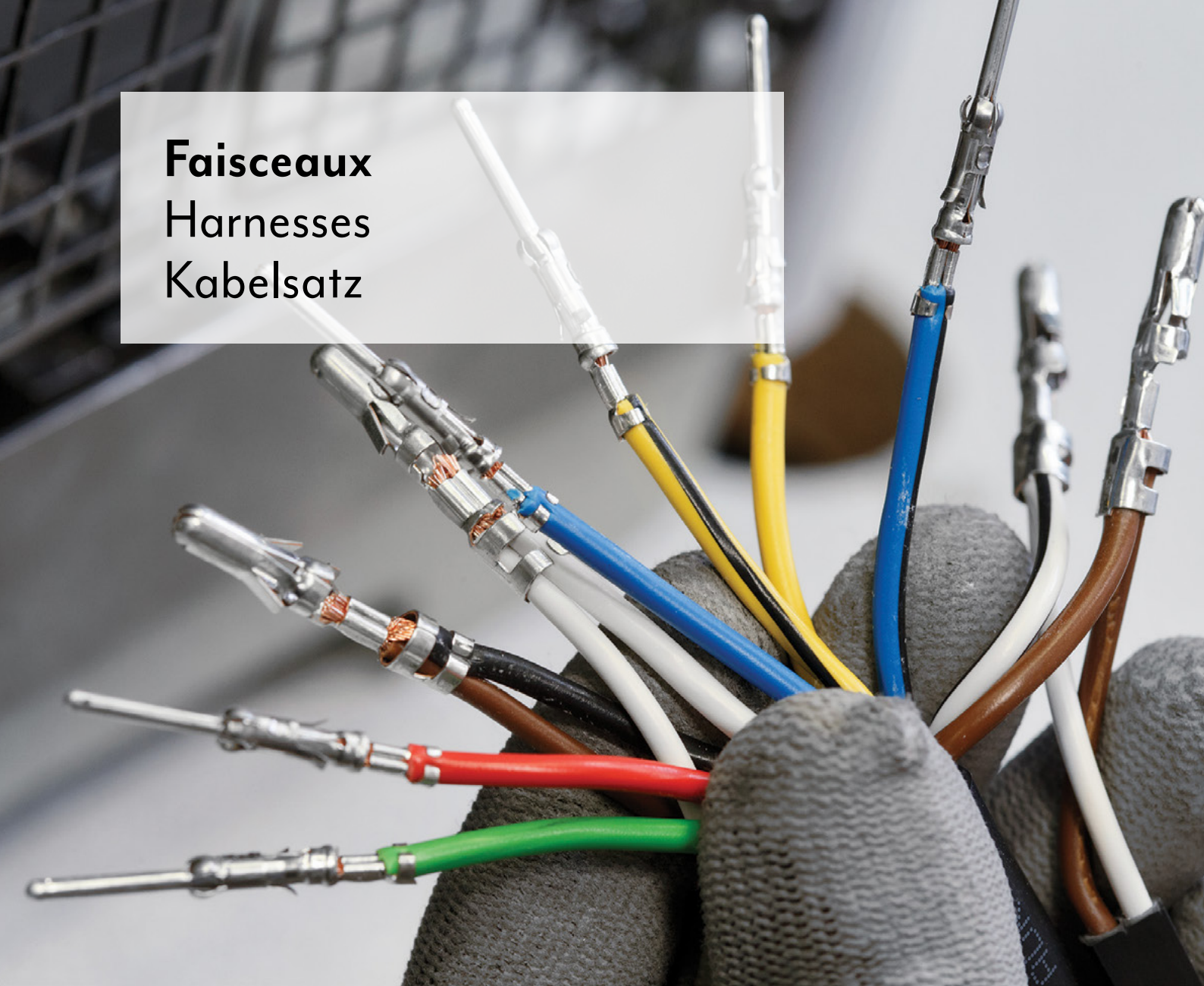

Flashez le QR code pour plus d'infos  
Scan the QR code for more info  
Scannen Sie den QR-Code für weitere Informationen

AMP 1.5-7P-M

Type connecteur - Nb pins - Mâle ou Femelle  
Connector type - Pins Nb - Male or Female  
Steckertyp - Stifte Nb - männlich oder weiblich



## ADP RSC



ADR



24N 24S / 15P

### ADAPTATEURS AVANT - FRONT ADAPTERS - ANSCHLUSSKABEL

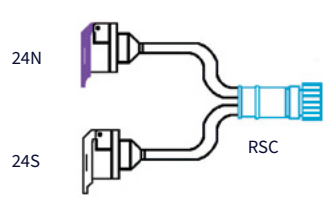

**D10504** 1000 mm 16V

**D13257** 1500 mm 15V

Faisceau prises 24N / 24S  
Cable with plugs 24N / 24S  
Anschlusskabel mit Steckdosen 24N / 24S

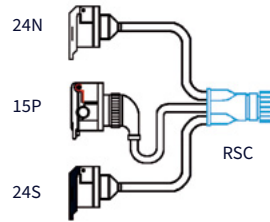

**D14780** 500 mm 16V

**D13256** 300 mm 15V

Faisceau prises 15P / 24N / 24S  
Cable with plugs 15P / 24N / 24S  
Anschlusskabel mit Steckdosen 15P / 24N / 24S

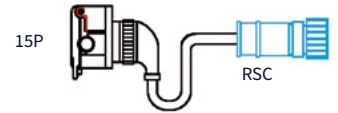

**D13254** 1000 mm 16V

**D13255** 600 mm 15V

Faisceau prises 15P  
Cable with plugs 15P  
Anschlusskabel mit Steckdosen 15P

#### Comment différencier rapidement les connecteurs RSC ? How to differentiate quickly the RSC connectors? Wie unterscheiden sich die verschiedenen RSC-Stecker ?

Un connecteur RSC 16 voies présente 4 pins centraux alors qu'un connecteur RSC 15 voies en présente 3 (voir schéma ci-contre).

A 16 pins RSC connector has 4 central pins while a 15 pins connector has 3 (see opposite draw).

Ein 16-poliger RSC-Stecker hat 4 zentrale Kontaktstifte, ein 15-poliger RSC-Stecker nur 3 (siehe nebenstehende Skizze).

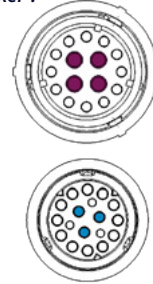

## PRL RSC



ADR

### CÂBLE D'ALIMENTATION PRINCIPALE - MAIN SUPPLY CABLE - HAUPTKABEL



**D10505** 16 m 16V

**D13263** 15 m 15V

Prolongateur RSC simple  
Single RSC Main supply cable  
Haupt-Verlängerungskabel für RSC

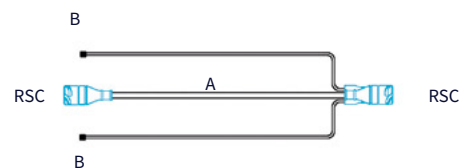

**D10510** A: 10 m / B: 10 m 16V

**D10508** A: 16 m / B: 16 m 16V

**D13260** A: 15 m / B: 0,27 m\* 15V

Prolongateur avec câbles plats  
Main supply cable with flat cables  
Haupt-Verlängerungskabel mit eingegossenem Flachkabel  
\* avec autoporants / with click-in / mit click-in



**D13249** 16V

Connecteur RSC femelle presse étoupe + contacts  
Female RSC connector with o'ring + contacts  
Weiblicher RSC Stecker mit Kabelverschraubung + Kontakt



**D13250** 16V

Connecteur RSC mâle presse étoupe + contacts  
Male RSC connector with o'ring + contacts  
Männlicher RSC Stecker mit Kabelverschraubung + Kontakt



Exemple de montage p. 272  
Assembly suggestion p. 272  
Montagebeispiel siehe S. 272

### ADAPTATEURS ARRIÈRE - REAR ADAPTERS - ANSCHLUSSKABEL

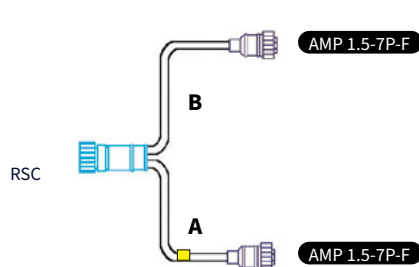

**D10513** A: 3,5 m / B: 3,5 m <sup>16V</sup>

Faisceau pour feux arrière avec surmoulages droits  
Rear lamp cable with straight overmoulding  
Leitungssatz für Heckleuchten mit geradem Anschlussstecker  
■ = gauche - left - links

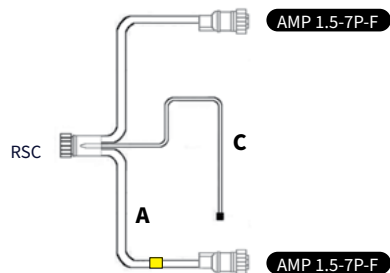

**D13262** A: 2,5 m / B: 1,5 m / C: 1,2 m <sup>15V</sup>

Faisceau pour feux arrière avec câbles plats et surmoulages droits  
Rear lamp cable with flat cables and straight overmoulding  
Leitungssatz für Heckleuchten mit geradem Anschlussstecker und Flachkabel für  
■ = gauche - left - links

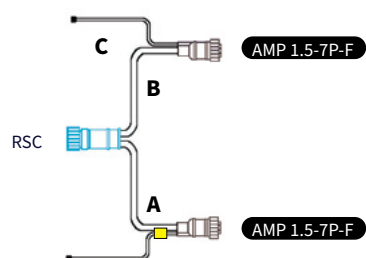

**D10514** A/B: 2 m / C: 0,5 m <sup>16V</sup>

**D10515** A: 1,5 m / B: 2,5 m / C: 16 m <sup>16V</sup>

**R12499** A: 2,5 m / B: 1,5 m / C: 0,5 m <sup>15V</sup>

Faisceau pour feux arrière avec câbles plats et surmoulages droits  
Rear lamp cable with flat cables and straight overmoulding  
Leitungssatz für Heckleuchten mit Flachkabel und geradem Anschlussstecker  
■ = gauche - left - links

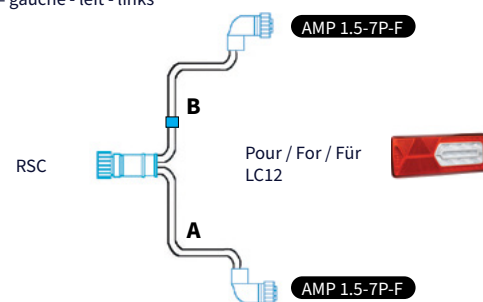

**R14407** A: 2 m / B: 2 m <sup>16V</sup>

Faisceau pour feux arrière LC12T avec surmoulages coudés  
LC12T Rear lamp cable with 90° overmoulding  
Leitungssatz für LC12T Heckleuchten mit 90° gewinkelter Stecker  
■ = gauche - left - links

## LED



24V

### BOITIER DE COMPATIBILITÉ LED VIGNAL

#### VIGNAL LED COMPATIBILITY GEAR - VIGNAL-LED-VORSCHALTGERÄT



Fonctions testées : position droit, position gauche, stop  
Funzioni testate: posizione destra, posizione sinistra, stop  
Funciones probadas : posición derecha, posición izquierda, stop

**D13237** fils nus - naked cable extremity - kabellitze

**D13502** pour module de jonction - for junction box - für Verteilerbox

**D13234** RSC Vignal 16 voies - poles - pölige stecker

**D13235** RSC Vignal 15 voies - poles - pölige stecker

## MDJ

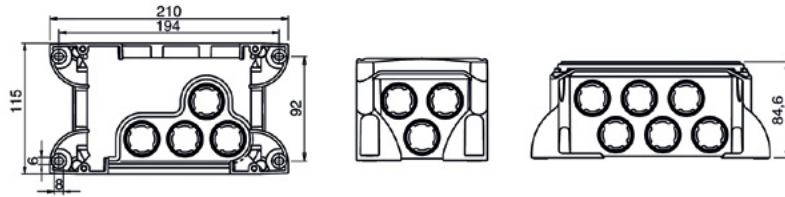

### SYSTÈME MDJ - BOX SYSTEM - VERTEILERDOSE



**175020**

**D11889**



**175086** cable Ø 5,9-6,9

**177136** cable Ø 8,3-10

**175096** cable Ø 11-12

## FCA

Pour feux arrière type LCR19 p.146

For rear lamps LCR19 p.146

Für Heckleuchten vom Typ LCR19 p.146



**NEW**

**D14984**

**AMP-MCP-4P-F**

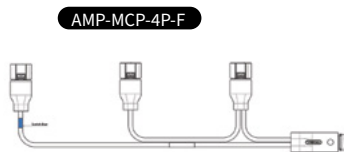

**D14980**

**AMP 1.5-7P-M**



**D14983**

**AMP-MCP-4P-F**

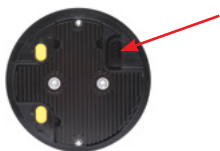

Affectations constructeurs  
OE applications  
Fahrzeugverwendung

SCHMITZ p.117

**AMP-MCP-4P-F**

**AMP-MCP-4P-F**

**AMP-MCP-4P-F**

**AMP-MCP-4P-F**



**D14846**

**HDSCS-6P-F**

gauche - left - links

**D14847**

**HDSCS-6P-F**

droit - right - rechts

**D14884**

**HDSCS-6P-F**

gauche - left - links

**D14885**

**HDSCS-6P-F**

droit - right - rechts



## CÂBLES FEUX ARRIÈRE - REAR LAMP CABLES - ANSCHLUSSKABEL HECKLEUCHTEN

ADR



AMP 1.5

Pour feux arrière type LC5, LC6, LC7, LC8, LC9, LC12 p.138

For rear lamps LC5, LC6, LC7, LC8, LC9, LC12 p.138

Für Heckleuchten vom Typ LC5, LC6, LC7, LC8, LC9, LC12 p.138



AMP 1.5-7P-F

**D11626** 2500 mm

**D11627** 4300 mm

Pour module de jonction 175020  
For junction box 175020  
Für Verteilerdose 175020



AMP 1.5-7P-F

**D11628** 2500 mm

Fils nus  
Naked cable extremity  
Kabellitze

AMP 1.5

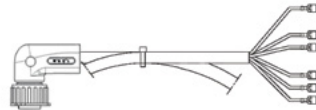

AMP 1.5-7P-F

**280049** 4000 mm

Fils nus  
Naked cable extremity  
Kabellitze

## RALLONGES - EXTENSION LEADS - VERLÄNGERUNGSSCHNUR



AMP 1.5-7P-M

AMP 1.5-7P-F

**D12449** 1000 mm

**D12450** 2000 mm

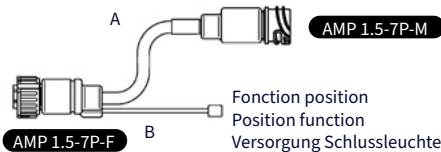

**R12575** A: 3 m / B: 3 m

**R12576\*** A: 0,5 m / B: 3 m

\* Pour / For / Für LC9 p. 167



## DOUBLEUR DE FEUX - DOUBLE REAR LAMP CABLE - KABEL FÜR ZWEI RÜCKLEUCHTEN



AMP 1.5-7P-F

AMP 1.5-7P-M

**D11689** 500 mm



## FCA



### CAPOT DE PROTECTION - PROTECTIVE COVER - SCHUTZKAPPE

175 mm x 68 mm x 52 mm



#### D14721

Capot de protection pour connectique coudée feu arrière  
Protective cover for rear lamp 90° connector  
Schutzkappe für Heckleuchte mit gewinkeltem Stecker

195 mm x 70 mm x 113 mm



#### D13725

Capot de protection pour connectique droite feu arrière  
Protective cover for rear lamp straight connector  
Schutzkappe für Heckleuchte mit geradem Stecker

## KIT



### KITS DE RÉPARATION POUR FEUX ARRIÈRE - REAR LAMPS REPAIR KITS - REPARATURSATZ FÜR HECKLEUCHTEN



#### D11868

Connecteur AMP 1.5 simple  
Single AMP 1.5 connector  
Anschlussstecker AMP 1.5

AMP 1.5-7P-F



#### D11865

Connecteur AMP 1.5 avec câble plat  
AMP 1.5 connector with flat cable  
Anschlussstecker AMP 1.5 mit Flachkabel

500 mm



ADR



AMP JPT

Pour éclairateurs de plaque EPP98 p. 181 et feux de position SMD98, FE98 et FPL93 p. 197

For number plate lamp EPP98 p. 181 and position lamp SMD98, FE98 and FPL93 p. 197

Für Kennzeichenleuchte EPP98 S.p. 181 und Markierungsleuchten SMD98, FE98 und FPL93 S.p. 197



### CÂBLES FEUX LATÉRAUX - SIDE MARKER LAMP CABLES - KABEL FÜR POSITIONSLAUCHTEN AMP JPT



JPT-2P-F

**280009** A : 2 m

**280019** A : 4 m

**280029** A : 6 m

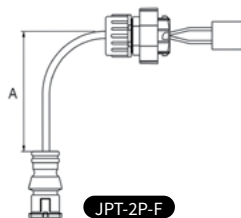

Pour / For / Für  
MDJ 175020

JPT-2P-F

**280039** A : 4 m

Fils nus  
Naked cable extremity  
Kabellitze

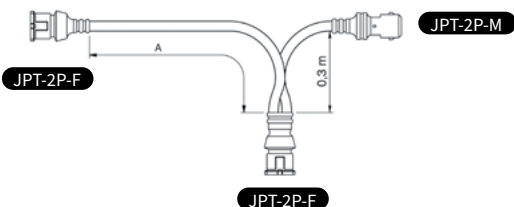

JPT-2P-F

JPT-2P-M

**280059** A : 3,5 m

**280069** A : 5,5 m

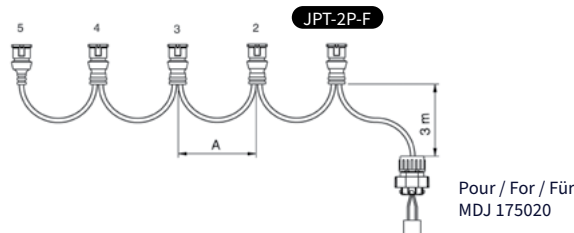

JPT-2P-F

Pour / For / Für  
MDJ 175020

3 x JPT	<b>280089</b>	A : 3,5 m	<b>280129</b>	A : 5,5 m
4 x JPT	<b>280099</b>	A : 3,5 m	<b>280139</b>	A : 5,5 m
5 x JPT	<b>280109</b>	A : 3,5 m	<b>280149</b>	A : 5,5 m

## KIT

### KITS DE RÉPARATION POUR FEUX LATÉRAUX - SIDE MARKER LAMPS REPAIR KITS REPARATURSATZ FÜR POSITIONSLAUCHTEN

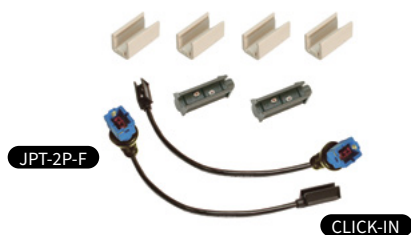

JPT-2P-F

CLICK-IN

**001796** 500 mm

**001806** 1500 mm



CLICK-IN

**001786** 500 mm



JPT-2P-F

**D13876**

Connecteur JPT 2 voies  
2 poles JPT connector  
Anschlussstecker 2 polig JPT



### CÂBLES FEUX LATÉRAUX - SIDE MARKER LAMP CABLES - KABEL FÜR POSITIONSLEUCHTEN SUPERSEAL



SUPERSEAL

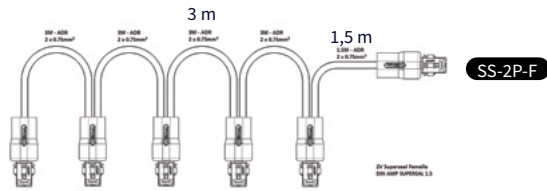

**R14173** 17,5 m

Pour éclairateurs de plaque LPL18, EPP96LED p. 179 et feux de position SMD98, DX p. 197

For number plate lamp LPL18, EPP96LED p. 179 and position lamp SMD98, DX p. 197

Für Kennzeichenleuchte LPL18, EPP96LED p. 179 und Markierungsleuchten SMD98, DX S.p. 197

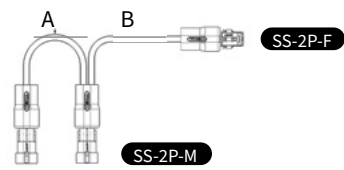

**R14418** A : 300 mm/ B:500 mm



**R14426** 1500 mm

Rallonge SUPERSEAL 2 voies  
2 poles SUPERSEAL extension lead  
Verlängerungsschnur Anschlussstecker 2 polig



## KIT



### KITS DE RÉPARATION POUR FEUX LATÉRAUX - SIDE MARKER LAMPS REPAIR KITS REPARATURSATZ FÜR POSITIONSLEUCHTEN



**D13880** SS-2P-F

Connecteur SUPERSEAL 2 voies femelle  
2 poles female SUPERSEAL connector  
Weiblich Anschlussstecker 2 polig

Pour / For / Für  
SMD98, FPL93, LC12, ICDL10,  
LPL18



**D14208** SS-2P-M

Connecteur SUPERSEAL 2 voies mâle  
2 poles male SUPERSEAL connector  
Männlich Anschlussstecker 2 polig



Câble plat  
Flat cable  
Flachkabel



**D11268** 16 m

**A10779** 100 m

Câble plat - Flat cable - Flachkabel



POS-2P-F

**D11147** 500 mm

Pour / For / Für  
LC8T



Câble plat optionnel avec connecteur 2 voies pour repiquage sur feu arrière LC8

Optional flat cable with 2-pin connector to plug-in LC8 rear lamp

Flachkabel mit 2-polig Anschlussstecker zum direkten Anschluss an die Heckleuchte LC8

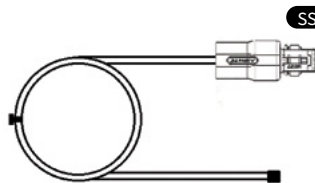

SS-2P-F

Pour / For / Für  
LC12T



**R14412** 16 m

Câble plat optionnel avec connecteur 2 voies SUPERSEAL pour repiquage sur feu arrière LC12T

Optional flat cable with SUPERSEAL 2-pin connector to plug-in LC12T rear lamp

Flachkabel mit SUPERSEAL 2-polig Anschlussstecker zum direkten Anschluss an die Heckleuchte LC12T

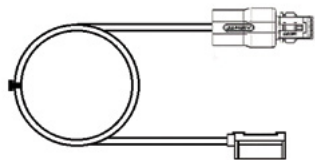

SS-2P-F

CLICK-IN

**R14416** 1500 mm



**R14339** 7,5 m

4V DT

Pour / For / Für  
CTL15



**R14338** 7,5 m

4V DT

Pour / For / Für  
BL15





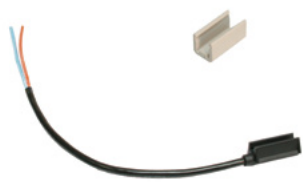

CLICK-IN

**D10517** 500 mm

**D10518** 1500 mm

**D10519** 3500 mm

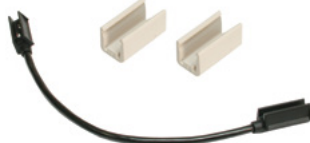

CLICK-IN

**D10132** 200 mm



**151236**

Verrou pour click-in à usage unique  
Clamp for click-in, single use  
Einmal click-in Riegel



**001826**

Obtuteur seal-in  
Seal-in obturator  
Verschlusshülse seal-in



**9115118**

Pince pour click-in  
Pliers for click-in  
Montagezange für click-in Befestigung



**4330012**

Bouchon pour câble plat  
Cap for flat cable  
Abschlussstopfen für Flachkabel



**D13251** 1 Kg

Graisse anti-corrosion  
Anti-corrosion grease  
Korrosionsschutzfett

# Systemes câblage et feux

## Wiring and lamps systems

### Verkabelung und Leuchten Systeme

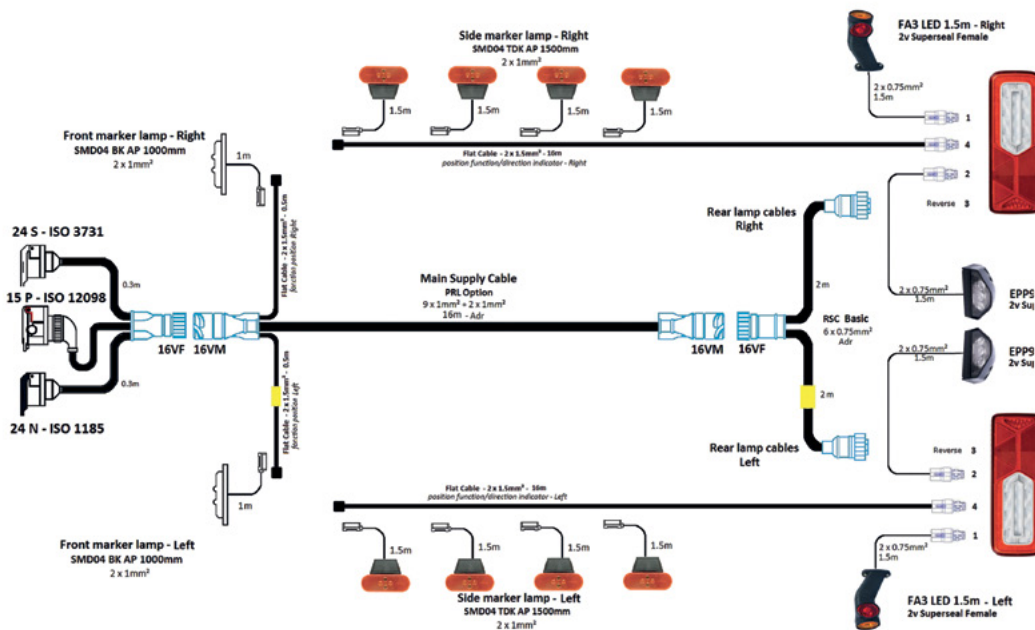
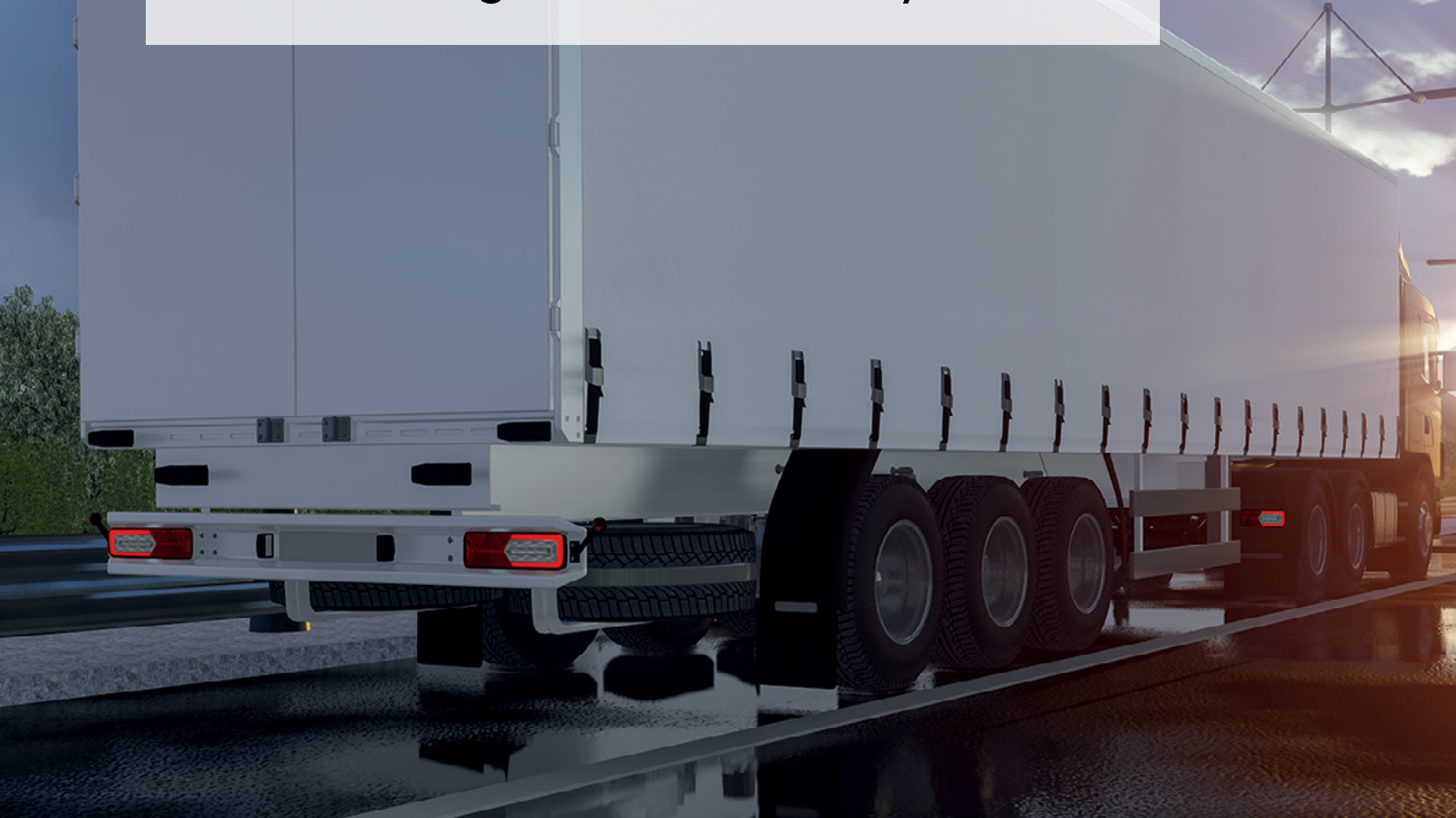

Flashez le QR code pour plus d'infos  
Scan the QR code for more info  
Scannen Sie den QR-Code für weitere Informationen

AMP 1.5-7P-M

Type connecteur - Nb pins - Mâle ou Femelle  
Connector type - Pins Nb - Male or Female  
Steckertyp - Stifte Nb - männlich oder weiblich

## KITS COMPLETS LED - LED COMPLETE KITS - LED GESAMT-KIT

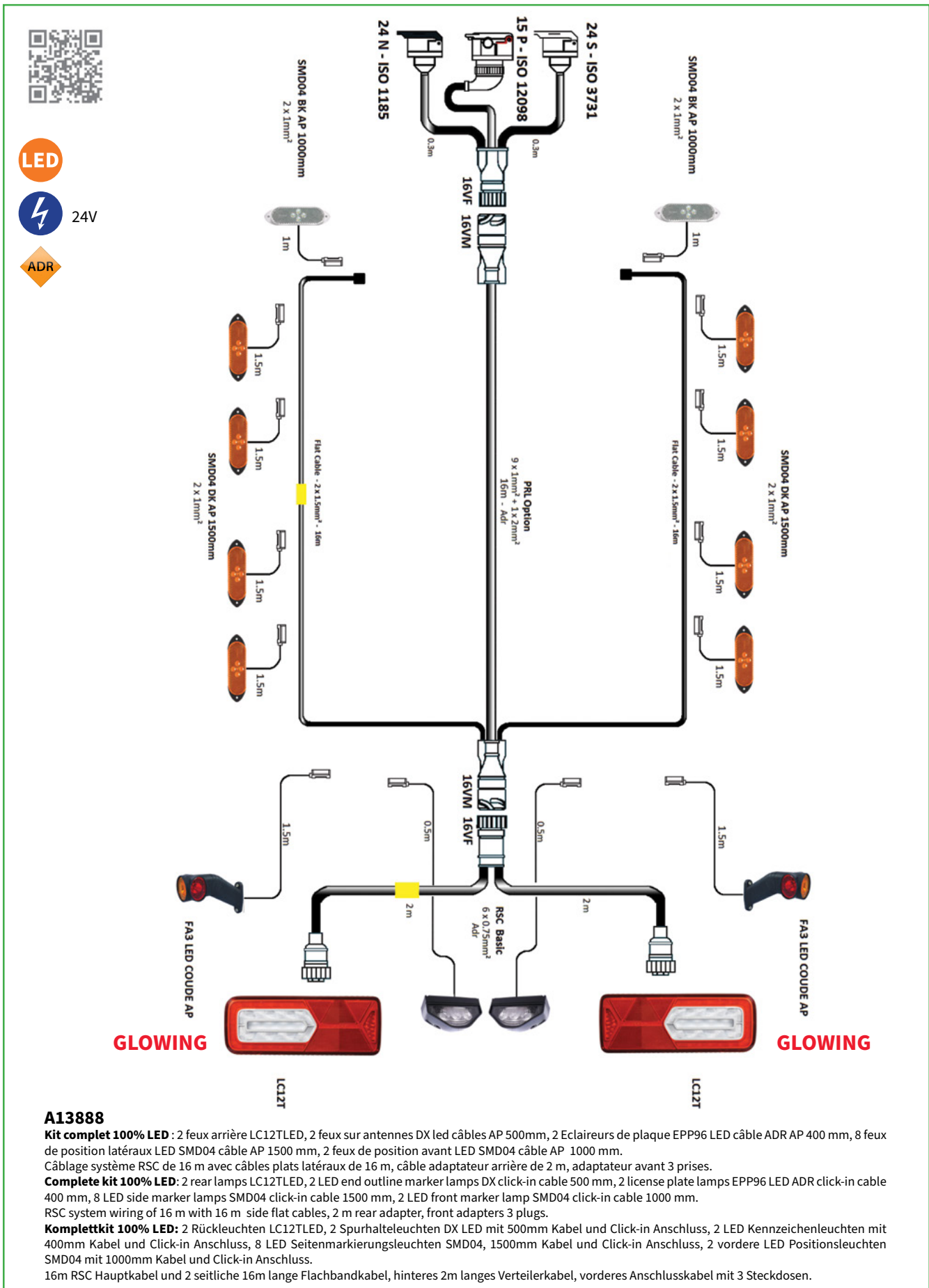

## KITS COMPLETS LED - LED COMPLETE KITS - LED GESAMT-KIT



FEUX DE POSITION LATÉRAUX LED CLIGNOTANTS gestion selon supplément 6 - R48  
 LED SIDE MARKER FLASHING LAMPS management supp 6 - R48  
 LED SEITLICHEN BLINKLEUCHTENT Ansteuerung gemäß der Erweiterung 6 - R48

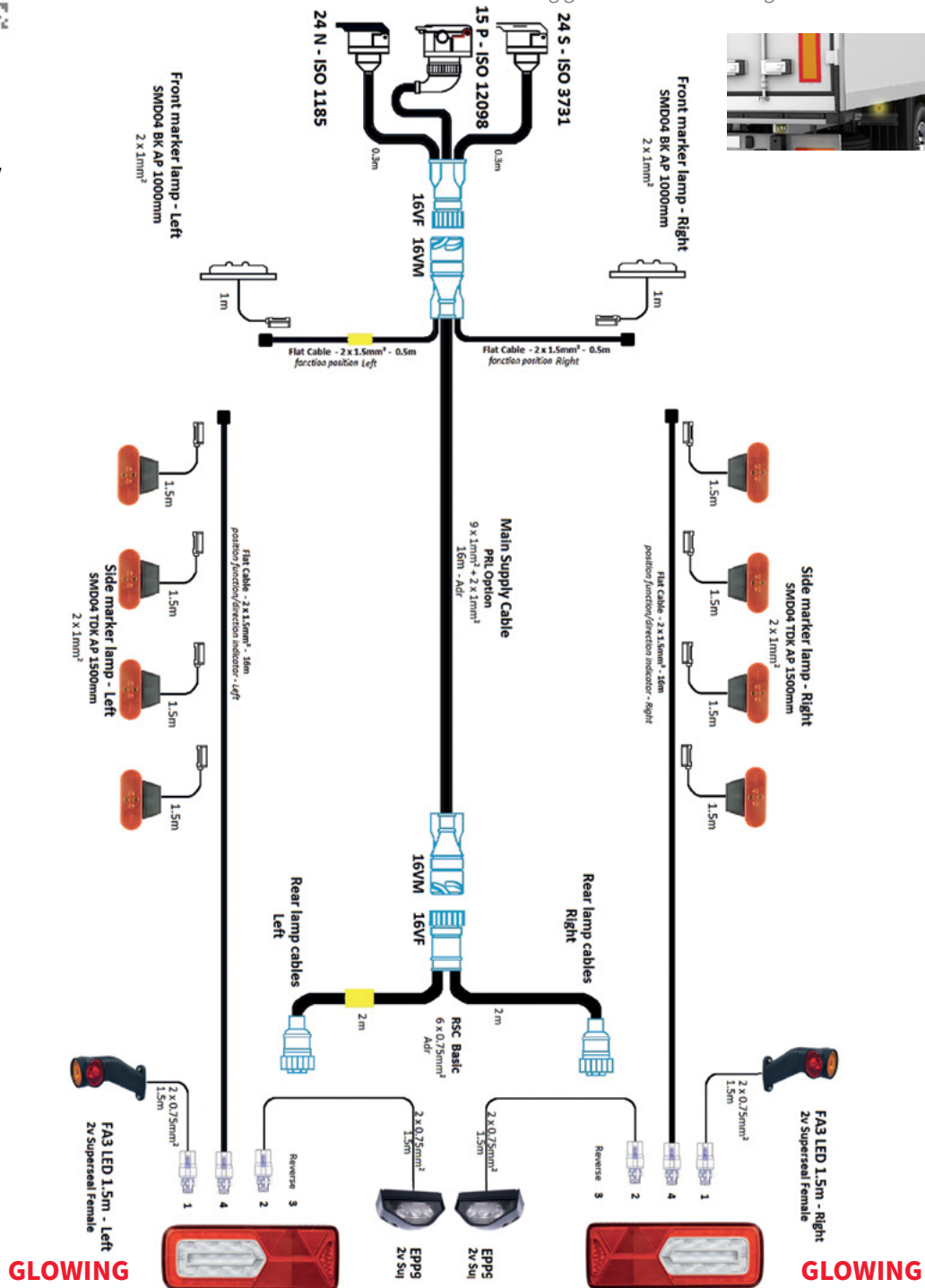

### A14366

**Kit complet 100% LED** : 2 feux arrière LC12TLED, 2 feux sur antennes DX led câbles SS 1,5 m, 2 Eclaireurs de plaque EPP96 LED câble ADR SS 1,5 m, 8 feux de position latéraux clignotants LED SMD04 câble AP 1500 mm, 2 feux de position avant LED SMD04 câble AP 1000 mm.

Câblage système RSC de 16 m avec câbles plats latéraux de 16 m connectique SS, câble adaptateur arrière de 2 m, adaptateur avant 3 prises.

**Complete kit 100% LED**: 2 rear lamps LC12TLED, 2 LED end outline marker lamps DX cable SS 1,5 m, 2 license plate lamps EPP96 LED ADR cable SS 1,5 m, 8 LED flashing side marker lamps SMD04 click-in cable 1500 mm, 2 LED front marker lamp SMD04 click-in cable 1000 mm.

RSC system wiring of 16 m with 16 m side flat cables SS connector, 2 m rear adapter, front adapters 3 plugs.

**Komplettkit 100% LED**: 2 Rückleuchten LC12TLED, 2 Spuralleuchte DX LED mit 1,5 m Kabel und SS Anschluss, 2 LED Kennzeichenleuchten mit 1,5 m Kabel und SS Anschluss, 8 LED Seitlichen Blinkleuchtent SMD04, 1500mm Kabel und Click-in Anschluss, 2 vordere LED Positionsluchten SMD04 mit 1000mm Kabel und Click-in Anschluss.

16m RSC Hauptkabel und 2 seitliche 16m lange Flachbandkabel mit SS Anschluss, hinteres 2m langes Verteilerkabel, vorderes Anschlusskabel mit 3 Steckdosen.



## KITS COMPLETS LED 13P - LED COMPLETE KITS 13P - LED GESAMT-KIT 13P



12V

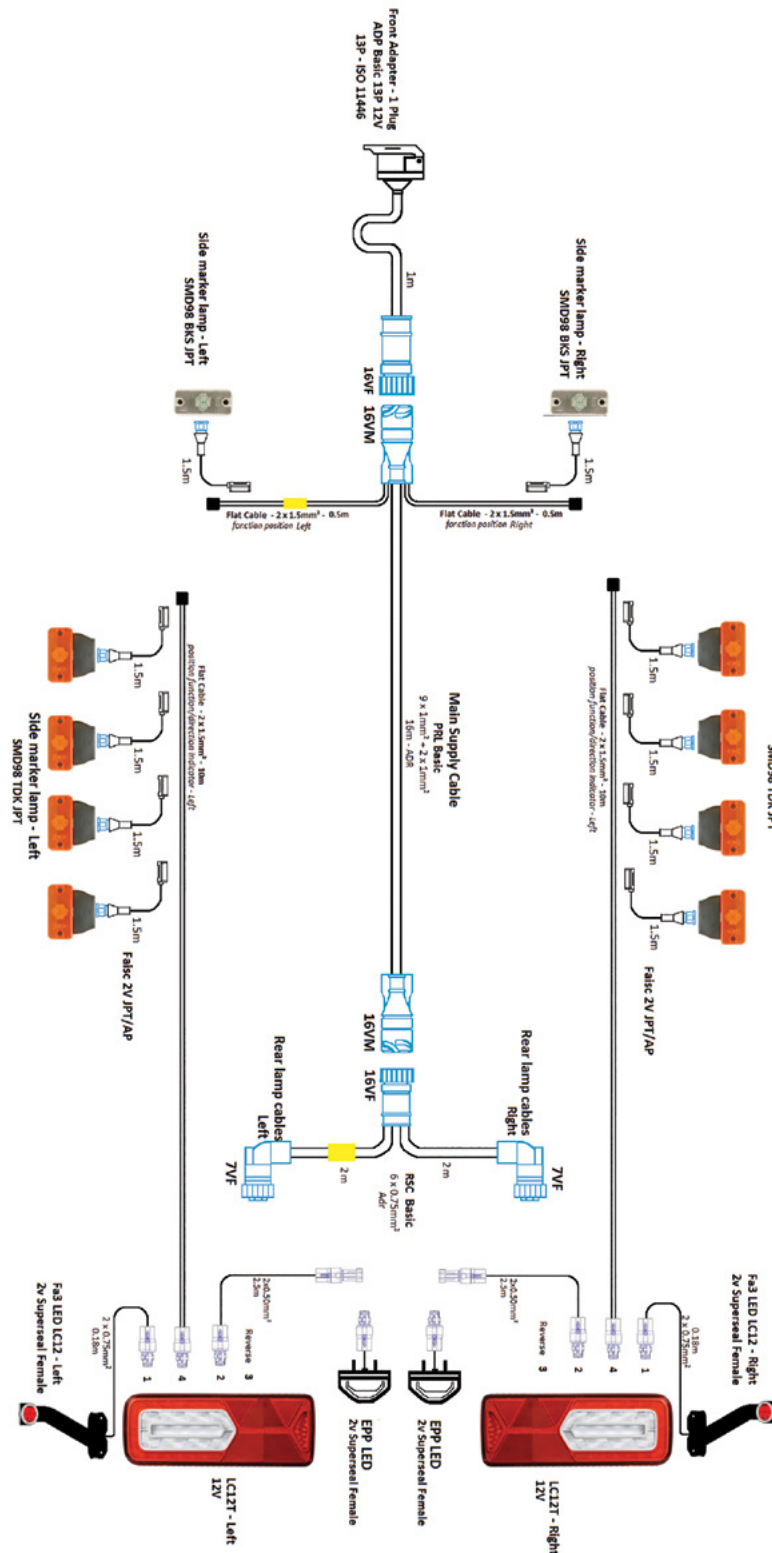

**NEW**

### A14838

**Kit complet 100% LED 12V :** 2 feux arrière LC12TLED, 2 feux sur antennes FA3 LC12 led câbles SS 1,8 m, 2 Eclaireurs de plaque BX868 LED câble ADR SS 2 m, 8 feux de position latéraux clignotants LED SMD98 + câble AP 1500 mm, 2 feux de position avant LED SMD98 + câble AP 1500 mm.

Câblage système RSC de 16 m, câbles plats latéraux de 10 m connectique SS, câble adaptateur arrière de 2 m, adaptateur avant 13P ISO1724.

**Complete kit 100% LED 12V:** 2 rear lamps LC12TLED, 2 LED end outline marker lamps FA3 LC12 led cable SS 1,8 m, 2 license plate lamps BX868 LED ADR cable SS 2 m, 8 LED flashing side marker lamps SMD98 + click-in cable 1500 mm, 2 LED front marker lamp SMD98 + click-in cable 1500 mm.

RSC system wiring of 16 m, 10 m side flat cables SS connector, 2 m rear adapter, front adapter 13P ISO1724.

**Komplettkit 100% LED 12V:** 2 Rückleuchten LC12TLED, 2 Spurhalteleuchten FA3 LC12 led mit 1,8 m Kabel und SS Anschluss, 2 BX868 LED Kennzeichenleuchten mit 2 m Kabel und SS Anschluss, 8 LED Seitlichen Blinkleuchten SMD98 + 1500mm Kabel und Click-in Anschluss, 2 vordere LED Positionsleuchten SMD98 + 1500mm Kabel und Click-in Anschluss.

16m RSC Hauptkabel, 2 seitliche 10m lange Flachbandkabel mit SS Anschluss, hinteres 2m langes Verteilerkabel, vorderes Anschlusskabel 13P ISO1724.

## KITS COMPLETS LED 7P - LED COMPLETE KITS 7P - LED GESAMT-KIT 7P



12V

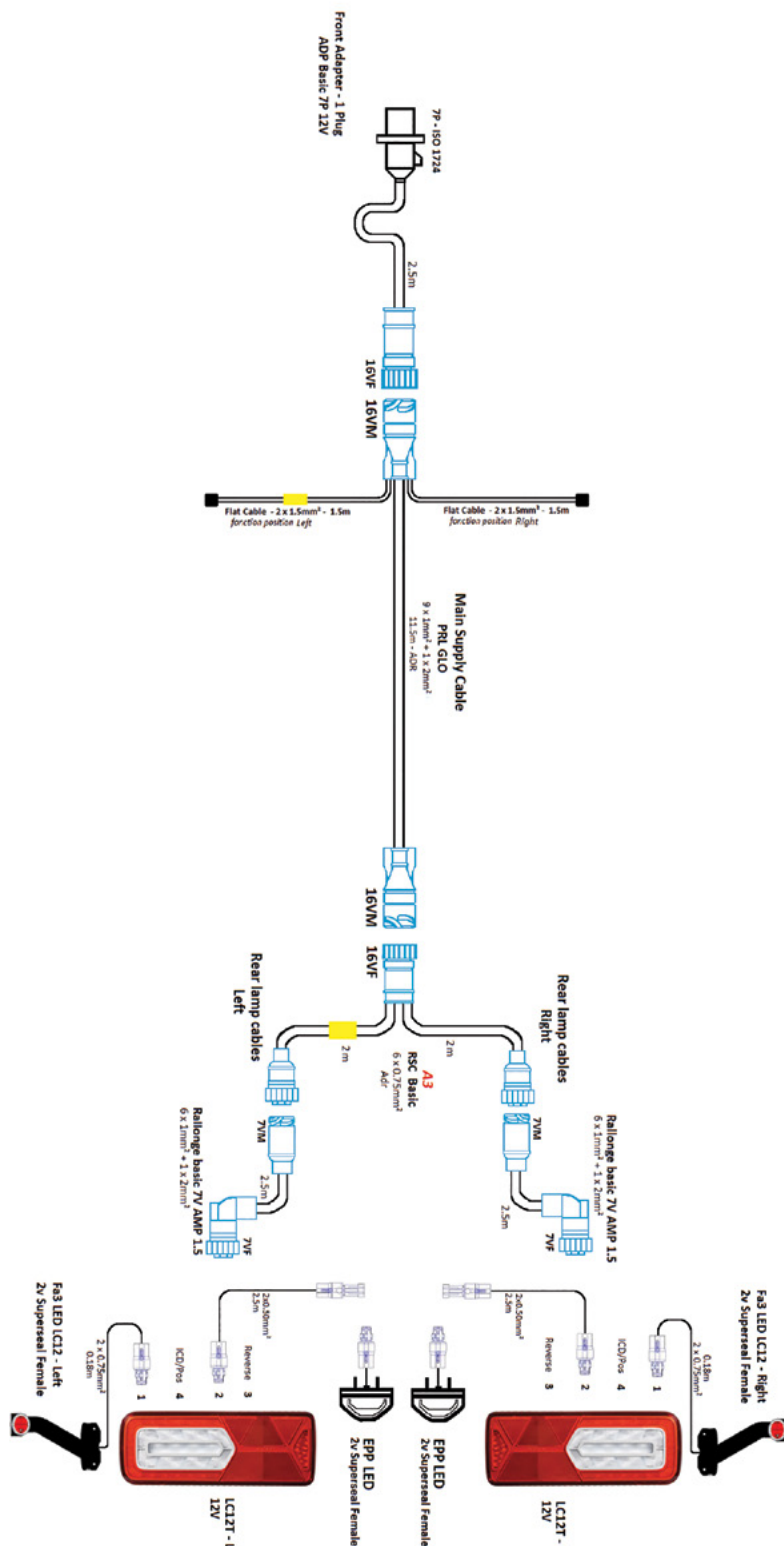

**NEW**

### A14715

**Kit complet 100% LED 12V :** 2 feux arrière LC12TLED, 2 feux sur antennes FA3 LC12 led câbles SS 1,8 m, 2 Eclairers de plaque BX868 LED câble ADR SS 2 m. Câblage système RSC de 11,5 m, câbles plats latéraux de 1,5 m connectique SS, câble adaptateur arrière de 2 m, adaptateur avant 7P ISO1724.

**Complete kit 100% LED 12V:** 2 rear lamps LC12TLED, 2 LED end outline marker lamps FA3 LC12 led cable SS 1,8 m, 2 license plate lamps BX868 LED ADR cable SS 2 m. RSC system wiring of 11,5 m, 1,5 m side flat cables SS connector, 2 m rear adapter, front adapter 7P ISO1724.

**Komplettkit 100% LED 12V:** 2 Rückleuchten LC12TLED, 2 Spurhalteleuchten FA3 LC12 led mit 1,8 m Kabel und SS Anschluss, 2 BX868 LED Kennzeichenleuchten mit 2 m Kabel und SS Anschluss. 11,5m RSC Hauptkabel, 2 seitliche 1,5 m lange Flachbandkabel mit SS Anschluss, hinteres 2m langes Verteilerkabel, vorderes Anschlusskabel 7P ISO1724.

# Index : Liste de correspondance - Cross-list - Hersteller-Nr.

	OES	VIGNAL		OES	VIGNAL
BOBCAT	728786	R12931	HEULIEZ	2773801	167150
	7027476	052500		2870801	167150
	7028787	R12934		3156201	067000
	7164110	152150		0190408700	181000
	7164111	152150		0190552400	181050
	7175124	196010		190825600	193020
	7322387	161140		5010104837	185050
	7322388	161150		5010217022	185020
	7322390	D14488		5010271501	195030
	7348957	D14324		5010312524	195060
	7348958	D14325			
	7387145	D14854			
CASE	5141966	198810	IVECO	791123	152180
	47363002	199000		1608352	001726
	47826594	D14191		41200664	193170
	875884890	D14156		41221040	119930
				41221041	119920
CLAAS	27108471	212400	42535711	052500	
	7700027564	196020	42555041	110530	
			42555042	110520	
		42555131	D12337		
		42555132	D12336		
DAF	0698603	040500	42566495	052500	
	0867930	196010	47363002	199000	
	1272653	067500	69500026	D12335	
	1284211	167640	69500032	D12334	
	1284212	167630	69500044	D12341	
	1284213	168100	69500047	D12340	
	1284214	168390	69500590	D12339	
	1304788	168010	69500591	D12338	
	1304789	168020	93161844	067500	
	1329718	193020	97163920	119550	
	1401713	152170	99463242	168600	
	1401731	152180	99463243	168590	
	1403887	195010	99463244	168610	
	1451482	052500	500308514	193020	
	1519368	D12953	500341613	198060	
	1608352	001726	500356782	D11481	
	1625985	169160	500356783	D11482	
	1625986	169170	504097923	193290	
	1626101	119550	580224029	160120	
	1626102	001616	5001834568	001616	
	1626319	168100	5801363428	169390	
	1626320	168390	5801363430	169400	
	1653605	193200	5801363431	169410	
	1660967	168890	5801363432	169420	
	1660968	169380	5801426889	153220	
	1814096	109010	5801426894	153210	
	1815754	109010	5801426912	153200	
	1846491	117000	5801426917	153230	
	1846492	117010	5801426975	153240	
	1875576	155110	5801426977	153250	
	1875577	155100	5801426979	153260	
	1875578	155120	5801572018	110560	
	1875579	155140	5801572024	110550	
	1875580	155130	5801631615	198760	
	1875581	155150	5801637182	155480	
	1914690	055020	5801637199	155450	
	1914691	055030	5801637201	155460	
	1973239	001830	5801637202	155470	
	2922224	141500	5801757326	155500	
			5801757328	155490	
			5802000568	160080	
			5802000570	160110	
		5802000573	160100		
		5802000767	160090		
		5802000770	160130		
FIAT	1305797	193170			
	71749250	193360			
	1356794080	193360			
	1372698080	153280			
	1372699080	153270			



# Index : Liste de correspondance - Cross-list - Hersteller-Nr.

	OES	VIGNAL		OES	VIGNAL	
IVECO	5802000772	160120	MANITOU	223767	152180	
	5802055272	155540		227330	D14517	
	5802055273	160140		564744	052500	
	5802062689	160150		661973	152180	
	5802240291	160150		959694	D14380	
	5802240292	160080		959695	D14381	
	5802240293	160110		52562043	D14380	
	5802240294	160140		52562044	D14381	
	5802240295	160100				
	5802240296	160090		MANITOWOC	03137250	156860
	5802240297	160130			03137251	156870
	A610067-002	052500			03137254	001830
	R504083205	168480			03138527	198660
					03320937	198520
					03320938	152180
	IVECO BUS	504217797		198650		03320939
5000461058		181000		03329492	198640	
5000461059		181050		03329572	D10493	
5001020257		119550				
5001834505		195030	MERCEDES	A 000 826 20 56	056540	
5001834564		001606	DAIMLER	A 000 826 21 56	056550	
5001834568		001616		A 906 820 04 64	156340	
5001834576		195060		A 906 820 17 64	156350	
5001837993		001626		A 910 206 29 00	212010	
5001847589		001726		A 910 820 64 00	160400	
5010104837		185050		A 910 820 65 00	160410	
5010179915		167150		A 910 826 10 00	060000	
5010197259		191170		A 910 826 11 00	060010	
5010197260		191110		A 910 906 36 00	212010	
5010197261		191140		A 910 906 69 00	212420	
5010197262		191120		A 949 540 01 04	196170	
5010217022		185020		A 956 544 00 11	198780	
5010286898		195000		A 956 820 00 59	116200	
5010306792		193020		A 959 544 01 03	155590	
50101972564		191150		A 959 544 02 03	155600	
			A 959 544 03 03	155610		
			A 960 820 02 58	212700		
KUBOTA	W20TS00777	D14513	MERLO	115855	D14479	
	W20TS01401	D14749		115856	D14513	
	W20TS01684	D14725		116119	D14508	
LECAPITAINE	661012	D11689				
	661058	164050				
MAN	7CE945095	155550	NEW HOLLAND	5141966	198810	
	7CE945096	155560		47363002	199000	
	81.25207-6074	212020		47826594	D14191	
	81.25207-6075	212030	51431987	D14654		
	8125225-6033	168090				
	8125225-6034	168100	NISSAN	26164-9X402	119550	
	8125225-6464	168090		26244-9X400	001616	
	8125225-6469	166700		26554-9X126	052500	
	8125225-6470	166700		26555-9X125	152180	
	8125225-6523	169170		26555-9X126	152170	
	8125225-6524	169160		26555-9X128	153120	
	8125225-6526	169180				
	8125225-6528	168490	OPEL	4421269	196010	
	8125225-6530	169190		4421265/6	152180	
	8125225-6544	156200				
	8125225-6545	156210	PEUGEOT CITROËN	9815126980	153280	
	8125225-6547	156220		9815127080	153270	
	8125229-6051	067500		63501FS	153280	
	8125229-6059	056500		6350FS	153270	
	8125229-6060	056510				
MANITOU	163782	500930	RENAULT TRUCKS	23811106	212740	
	163783	500940		23811107	212750	
				5000296591	166000	
			5000296591	166100		

# Index : Liste de correspondance - Cross-list - Hersteller-Nr.

	OES	VIGNAL		OES	VIGNAL
RENAULT TRUCKS	5000296592	167000	RENAULT TRUCKS	7421430181	104570
	5000296592	167100		7422800385	158030
	5000296593	066000		7422800386	158040
	5000296594	067000		7422800391	058000
	5000296718	088010		7423080010	158050
	5000461058	181000		7423292490	059500
	5000461059	181050		7423374865	D10596
	5000623050	188310		7423467438	159520
	5000807304	040000		7423530438	159520
	5000808166	040500		7423530440	159500
	5000808171	141000		7423530441	159510
	5000808172	141500		7423530442	159530
	5001831194	168220		7425982261	158030
	5001832999	168260		7482252291	115040
	5001834561	195010		7482252506	115000
	5001834565	119450		7482255014	115030
	5001834568	001616		7482266219	113020
	5001835853	168140		7482285707	113030
	5001846843	152000		7482346591	115020
	5001846844	152010		7482367030	115010
	5001846845	152040		7482392733	198620
	5001846846	152050		7482522006	104570
	5001846847	152020		7482586940	198740
	5001846848	152030		7484185589	D14161
	5001846849	152060		7484538758	193020
	5001846850	152070		7484585204	158040
	5001847153	052500		7484585206	158050
	5001847582	169060		7484585208	158030
	5001847583	169070		7485118470	152170
	5001847584	169000		7700353021	196020
	5001847585	169010		7700377130	D14590
	5001847586	169020		7700377208	198510
	5001847587	169030		8200602314	D14593
	5001847588	067500		265100848R	196010
	5001847589	001726		265500292R	152180
	5001847597	119470		265504514R	152180
	5001857964	152510		265550674R	152180
	5001857965	152520		265551402R	152180
	5001858092	152500			
	5001858093	152600	SCANIA	1350343	067500
	5001862030	102200		1365963	168350
	5001862030	193200		1365964	168360
	5001864535	169310		1756751	156780
	5001864536	169320		1756754	156770
	5001870556	152180		1784669	056540
	5010217022	185020		1784670	056550
	5010217023	185040		1791369	156790
	5010271807	185160		2020496	D10596
	5010293829	196010		2021575	156780
	5010306792	193020		2021576	156790
	5010392231	052000		2021578	155020
	5010595381	152170		2021579	156770
	5010595382	152180		2129985	156770
	7420802348	159010		2129986	155020
	7420802350	159020		2129987	156780
	7420802353	159030		2129988	156790
	7420802418	059000		2129991	056550
	7420862032	152880		2129992	056540
	7420862035	152880		2160127	155090
	7420862038	152190		2160128	155080
	7420862041	152200		2340796	155520
	7420894265	193280		2862201	D14852
	7421106206	198650			
	7421137718	104450	SCHMITZ	1302341	161000
	7421268609	191170		1302342	161010
	7421396991	D13019		1348566	D14488

# Index : Liste de correspondance - Cross-list - Hersteller-Nr.

	OES	VIGNAL		OES	VIGNAL
SCHMITZ	1364736	161000	VOLVO	21735301	159520
	1364737	161010		23354972	158030
	1370066	161280		23354973	158040
	1370067	161290		23354974	158050
	1415545	213010		23522304	159520
	1415546	213090		23522305	159530
STEYR	48159167	D14156	23522307	159500	
	51431987	D14654	23522308	159510	
			23690764	159520	
UD TRUCKS	84655961	120000	23690765	159530	
	261319Z01B	153860	23690769	159500	
	261319Z01C	153870	23742314	212730	
	261319Z01D	153880	82114500	107010	
	265109Z00A	196010	82114502	107050	
	265509Z00A	052500	82114504	107040	
VF VENIERI	101 1 102	D14548	82114506	107000	
	101 2 421	D14478	82116545	207000	
	101 4 211	D14509	82150539	114010	
	101 4 681	D14508	82151157	111000	
	101 4 734	D14324	82151205	111010	
	101 4 735	D14325	82202076	113000	
VOLKSWAGEN	2E0 945 095 A	156340	82278930	112010	
	2E0 945 096 A	156350	82278938	112000	
	2E0 945 111 A	056540	82348508	116040	
	2E0 945 112 A	056550	82349220	116010	
	7CA 945 091	152180	82349221	116000	
	7CA 945 092	152180	82355678	107000	
	7CA945095	155570	82355684	107010	
	7CA945096	155580	82467736	107500	
			82467737	107510	
VOLVO	20537280	052000	82483073	159510	
	20717520	102200	82483074	159500	
	20721495	196010	82849894	158030	
	20734485	193020	82849905	058000	
	20745060	052500	82849923	158050	
	20745066	001726	82849925	158040	
	20745225	195010	84044658	198740	
	20745227	001616	84122332	059500	
	20769775	159010	84139927	107000	
	20769776	159020	84139939	107010	
	20769777	159030	84185589	D14161	
	20769781	152880	84195505	158030	
	20769782	152880	84195519	158040	
	20769783	152190	84195521	158050	
	20769784	152200	84441759	159500	
	20789440	198620	84441760	159510	
	20802418	059000	84441766	158030	
	20872890	D12111	84441767	158040	
	21087346	207010	84441768	158050	
	21087347	207020	84441936	159520	
	21214524	114020	84441937	159530	
	21214534	114000	84538758	193020	
	21341202	119550	85105029	001766	
	21346521	111020	VOLVO BUS	20480486	198650
	21346522	111030	70364301		198640
	21368779	116050	VOLVO CONSTRUCTION	11170068	198520
	21368781	116060		23374865	D10596
	21368782	116030			
	21368783	116020			
	21396991	D13019			
	21448885	107040			
	21478751	107050			
	21735299	159530			

# Index : Références - Part numbers - Artikelnummern

000046	171	094026	199	115030	88	153870	124
000086	188, 212	094036	192	115040	88	153880	124
000176	181, 192, 199, 204, 211,	094046	192	116000	129	153890	124
001586	52, 192, 199, 204	094056	204	116010	129	155020	115, 155
001596	192, 199, 204	094066	204	116020	129	155080	115, 155
001606	58	102200	193, 250	116030	129	155090	115, 155
001616	184, 187	104090	139, 196	116040	129	155100	23, 150
001619	183, 186	104100	139, 196	116050	129	155110	23, 150
001626	40, 54, 55, 56, 59	104130	191	116060	129	155120	23, 150
001696	191, 197, 199, 200, 203	104140	191	116200	78	155130	23, 150
001706	170	104170	202	117000	25, 186	155140	23, 150
001716	191, 197, 199, 200, 203	104180	202	117010	25, 186	155150	23, 150
001726	193, 200, 250	104210	196	119450	187	155450	44, 152
001766	130, 198	104220	196	119470	187	155460	44, 152
001786	309	104250	196	119550	187	155470	44, 152
001796	309	104260	196	119920	47, 183	155480	44, 152
001806	309	104290	190	119930	47, 183	155490	44, 152
001826	312	104300	190	120000	124, 186	155500	44, 152
001830	274	104310	190	141000	171	155520	115, 155
001846	158	104330	202	141500	171	155540	44, 152
001872	153, 274	104340	202	151236	312	155550	70, 153
001916	200	104360	202	152000	100, 104	155560	70, 153
014580	184	104450	190	152010	100	155570	126, 151
040000	171	104510	190	152020	95, 101, 105	155580	126, 151
040500	171	104520	191	152030	101	155590	76
052000	161	104570	190	152040	100	155600	76
052500	162, 163	104640	196	152050	100	155610	76
053700	164, 165	104650	196	152060	101	156040	157
053710	164, 165	104670	196	152070	101	156050	157
055020	150, 151	104680	202	152130	161	156060	157
055030	150, 151	104690	191	152140	161	156070	157
055040	152	104700	196	152150	161	156130	157
055050	152	104710	202	152160	161	156200	70, 153
056000	154	104720	191	152170	161	156210	70, 153
056010	154	107000	128, 131, 185	152180	161	156220	70, 153
056020	156	107010	128, 131, 185	152190	161	156250	32, 66, 159
056030	156	107040	128, 131, 185	152200	161	156260	32, 66, 159
056500	153, 154	107050	128, 131, 185	152500	95, 105	156290	154
056510	153, 154	107500	131, 185	152510	95, 105	156300	62, 154
056540	155, 156	107510	131, 185	152520	95, 105	156310	62, 154
056550	155, 156	109010	24, 186	152600	104	156340	77, 126, 156
056700	158	110520	183	152880	100, 104, 133	156350	77, 126, 156
056710	158	110530	183	153000	164	156380	66, 159
056720	159	110550	183	153010	164	156390	66, 159
056730	159	110560	183	153020	164	156540	20, 154
058000	142	111000	127, ,185	153030	164	156550	20, 154
059000	160	111010	127, ,185	153040	164	156590	156
059500	143	111020	127, ,185	153050	164	156600	156
060000	140, 141	111030	127, ,185	153060	164	156630	157
060010	140, 141	112000	128	153070	164	156640	157
066000	170	112010	128	153120	81, 161	156770	115, 155
066500	170	112110	211	153130	66, 164	156780	115, 155
067000	166, 167, 168	112120	211	153200	45, 163	156790	115, 155
067500	166, 167, 168	112130	211	153210	45, 163	156860	75
067600	169	112140	211	153220	45, 163	156870	75
067610	169	112710	211	153230	45, 163	158030	86, 127, 142
080026	195	112720	211	153240	45, 163	158040	86, 127, 142
080046	195	113000	129	153250	45, 163	158050	86, 127, 142
087020	194	113020	88	153260	45, 163	159010	87, 132, 160
087030	205	113030	88	153270	34, 85, 162	159020	87, 132, 160
087040	188, 201	114000	128	153280	34, 85, 162	159030	87, 132, 160
088010	211	114010	128	153660	165	159500	87, 99, 131, 143
094016	199	114020	128	153670	165	159510	87, 99, 131, 143
		115000	88	153700	165	159520	87, 99, 131, 143
		115010	88	153710	165	159530	87, 99, 131, 143
		115020	88	153860	124	160080	43, 140

# Index : Références - Part numbers - Artikelnummern

160090	43, 140	168390	27	193360	200	213070	146
160100	43, 140	168480	47, 167	194010	199	213090	117, 146
160110	43, 140	168490	71	194020	199	213150	146
160120	43, 140	168590	48, 51, 53, 167	194030	199	213160	146
160130	43, 140	168600	47, 51, 53, 167	194070	199	213200	146
160140	43, 140	168610	47, 48, 49, 167	194080	199	240346	216
160150	43, 140	168770	169	194090	199	240356	216
160400	77, 141	168780	169	194130	192	240366	216
160410	77, 141	168790	169	194140	192	241346	216
161000	138	168800	169	194150	192	241356	216
161010	138	168830	169	194190	192	241366	216
161120	138	168890	24	194250	204	280009	309
161130	138	169000	90, 94, 100	194260	204	280019	309
161140	14	169010	90, 94, 100	194270	204	280029	309
161150	14	169020	90, 94	194310	204	280039	309
161180	138	169030	90, 94	195000	58	280049	307
161190	138	169060	91, 96	195010	193	280059	309
161200	138	169070	91, 96	195030	193	280069	309
161210	138	169160	24, 71, 167	195060	205	280089	309
161260	61, 138	169170	24, 71, 167	196010	181	280099	309
161270	61, 138	169180	71, 167	196020	181	280109	309
161280	82, 117, 138	169190	71, 167	196170	181	280129	309
161290	82, 117, 138	169310	90, 94	198010	198	280139	309
161420	138	169320	90, 94	198020	198	280149	309
161430	138	169380	24	198030	198	300000	64, 250
161460	138	169390	46, 168	198040	192	300010	64, 250
161470	138	169400	46, 168	198050	192	500930	73, 175
161500	138	169410	46, 168	198060	203	500940	73, 175
161510	138	169420	46, 168	198510	197	521010	195
161560	138	175020	306	198520	197	521050	195
161570	138	175086	306	198530	197	610080	210
163010	148	175096	306	198540	197	611010	210
164000	19, 144	177136	306	198580	107	611020	210
164010	19, 65, 144	180010	195	198620	88, 130, 198	611070	295
164020	123, 144	180040	195	198640	203	611080	295
164030	123, 144	181000	212	198650	197	611110	295
164050	65	181050	188	198660	191	611140	295
165020	19, 65, 144, 229	181070	188	198690	191	611150	295
165030	19, 65, 144, 229	185010	194	198740	88, 130, 198	611410	296
165040	35, 123, 144, 229	185020	194	198760	78, 197	611500	294
165050	35, 123, 144, 229	185030	205	198810	197	611510	294
166000	170	185040	187	199000	16, 80, 179	611520	294
166100	170	185050	205	199020	179	611530	294
166500	39, 55	185160	187	199030	179	611540	294
166600	170	187120	194	199040	62, 179	611550	294
166700	72	187130	205	207000	129, 132	611560	297
167000	166	187140	188, 201	207010	129, 132	611570	297
167100	166	187720	194	207020	129, 132	611580	294
167150	39, 56	187730	205	212010	77, 253	611590	294
167500	166	187760	188, 201	212020	70, 252	624016	216
167530	169	188010	211	212030	70, 252	624026	216
167550	169	188110	211	212120	252	624036	216
167600	166	188210	211	212160	252	630100	274
167630	24	188310	211	212170	253	630110	274
167640	24	188610	211	212400	22, 252	630120	274
168010	24, 168	188710	211	212420	29, 77, 114, 252	672410	201
168020	24, 168	191110	59	212460	42, 252	725002	173, 174
168090	71, 166	191120	59	212470	252	725010	173
168100	27, 71, 166	191140	59	212520	74, 253	725012	173, 174
168140	95	191150	59	212560	253	725020	173
168220	91, 95, 112	191170	59, 102	212570	253	725022	173, 174
168260	91, 95, 112	193020	200	212710	76, 253	725032	173, 174
168270	166	193170	200	212730	130, 253	725040	173
168340	166	193200	193	212740	86, 253	726290	174
168350	116	193280	200	212750	86, 253	726300	174
168360	116	193290	200	213010	117, 146	726310	173

# Index : Références - Part numbers - Artikelnummern

726320	173	D11578	296	D13710	191	D14328	276
726350	174	D11626	307	D13713	197	D14331	301
726450	174	D11627	307	D13725	308	D14345	149
726460	174	D11628	307	D13807	274	D14347	277, 279
4330012	312	D11689	307	D13808	274	D14348	149
9115118	312	D11865	308	D13810	274	D14352	302
60760541	175	D11868	300, 308	D13816	149	D14353	272
60760551	175	D11888	181	D13817	148	D14354	272
67513361	175	D11889	306	D13860	272	D14357	239
67513371	175	D11899	210	D13862	272	D14358	239
67513380	175	D12111	130, 237	D13863	272	D14362	196, 301
67513390	175	D12334	50, 172	D13874	180	D14380	73
A10060	296	D12335	50, 172	D13875	207	D14381	73
A10061	296	D12336	50, 172	D13876	300, 309	D14387	228
A10062	297	D12337	50, 172	D13877	300	D14421	207
A10064	296	D12338	50	D13878	300	D14422	207
A10065	297	D12339	50	D13879	300	D14423	207
A10066	297	D12340	50	D13880	301, 310	D14424	207
A10779	311	D12341	50	D13881	282	D14425	139, 207
A11212	316	D12390	220	D13889	296	D14426	139, 207
A13888	314	D12428	209	D14030	207	D14427	207
A14366	315	D12429	209	D14031	207	D14428	207
A14420	123, 145	D12430	165, 209	D14034	207	D14429	207
A14715	318	D12449	307	D14035	207	D14430	207
A14838	317	D12450	307	D14037	158, 208	D14431	207
D10132	312	D12471	165, 209	D14038	158, 208	D14432	207
D10227	181	D12472	165, 209	D14039	158, 208	D14434	302
D10493	197	D12473	165, 209	D14040	158, 208	D14435	302
D10494	197	D12488	236	D14063	277	D14436	302
D10495	197	D12699	196	D14091	281	D14437	302
D10496	197	D12711	158, 209	D14116	180	D14447	227
D10497	197	D12712	158, 209	D14148	282	D14451	259
D10498	197	D12713	215	D14156	236	D14452	259
D10499	203	D12714	215	D14159	236	D14453	259
D10500	191	D12715	215	D14160	227	D14454	262
D10502	181	D12867	197	D14161	227	D14455	262
D10503	210	D12953	160, 168, 274	D14165	247	D14456	262
D10504	304	D13019	237	D14166	247	D14457	262
D10505	304	D13034	158, 209	D14167	246	D14462	260
D10508	304	D13035	158, 209	D14170	301	D14463	260
D10510	304	D13205	215	D14188	149	D14464	260
D10513	305	D13206	215	D14189	149	D14465	260
D10514	305	D13207	215	D14190	272	D14466	260
D10515	305	D13234	305	D14191	234	D14467	261
D10517	312	D13235	305	D14192	234	D14468	261
D10518	312	D13237	305	D14195	277, 279	D14469	261
D10519	312	D13249	304	D14208	301, 210	D14470	261
D10596	217	D13250	304	D14214	300	D14471	261
D10597	297	D13251	312	D14216	277	D14472	267
D10642	210	D13254	304	D14236	277	D14473	267
D10643	210	D13255	304	D14249	239	D14474	267
D10800	210	D13256	304	D14250	239	D14475	262
D10839	176	D13257	304	D14311	297	D14476	262
D10840	176	D13260	304	D14312	295	D14477	261
D10841	176	D13262	305	D14313	295	D14478	261
D10873	294	D13263	304	D14314	295	D14479	261
D10874	294	D13277	210	D14315	296	D14480	261
D11147	210, 311	D13288	161	D14316	295	D14481	262
D11268	190, 311	D13502	305	D14320	243	D14482	257
D11399	191	D13609	180	D14321	243	D14483	257
D11400	203	D13610	180	D14322	243	D14484	257
D11479	50, 172	D13617	282	D14323	243	D14485	257
D11480	50, 172	D13620	283, 285	D14324	242	D14486	257
D11481	50, 172	D13621	283, 285, 288	D14325	242	D14487	255
D11482	50, 172	D13622	283, 285, 288	D14326	277, 279	D14488	255
D11487	296	D13624	210	D14327	282	D14489	255

# Index : Références - Part numbers - Artikelnummern

D14490	255	D14578	296	D14749	260	D14935	270
D14491	255	D14587	216	D14750	260	D14942	298
D14492	255	D14588	216	D14751	260	D14943	298
D14493	255	D14589	216	D14752	255	D14944	298
D14494	255	D14590	216	D14753	255	D14945	298
D14495	255	D14591	216	D14754	255	D14947	298
D14496	255	D14592	216	D14755	255	D14948	298
D14500	254	D14593	216	D14756	254	D14949	298
D14501	254	D14594	216	D14757	254	D14950	298
D14502	254	D14595	216	D14758	254	D14951	298
D14503	254	D14596	216	D14759	220	D14955	290
D14504	267	D14598	249	D14760	269	D14956	290
D14505	267	D14649	244	D14762	269	D14963	241
D14506	267	D14653	239	D14769	239	D14964	241
D14507	256	D14654	236	D14770	239	D14965	226
D14508	256	D14655	207	D14771	239	D14966	226
D14509	256	D14673	246	D14778	260	D14967	226
D14510	256	D14677	286	D14779	255	D14968	224
D14511	263	D14678	288	D14780	304	D14970	222
D14512	263	D14679	288	D14781	208	D14971	223
D14513	263	D14680	286	D14782	208	D14980	147
D14514	233, 263	D14681	288	D14802	296	D14983	147
D14515	263	D14682	288	D14803	279	D14984	147
D14517	181	D14683	288	D14804	279	D14985	179
D14518	177	D14684	288	D14805	278	D14989	270
D14523	177	D14685	285, 288	D14806	280	D14990	216
D14524	177	D14689	296	D14807	283	D14991	216
D14525	177	D14690	246	D14808	283	D14993	246
D14526	177	D14706	214	D14811	220	D14995	290
D14527	177	D14707	214	D14824	296	D23300	266
D14532	214	D14708	214	D14846	147	D23301	266
D14533	214	D14709	214	D14848	118	D23400	266
D14534	214	D14710	214	D14849	118	D23401	266
D14535	214	D14711	214	D14850	222	D23500	266
D14536	214	D14712	214	D14851	223	D23501	266
D14537	292	D14713	214	D14852	223	D23600	266
D14538	292	D14714	215	D14853	225	D23601	266
D14539	292	D14715	215	D14854	225	R12486	301
D14540	230	D14716	215	D14855	225	R12499	305
D14541	230	D14721	308	D14856	223	R12575	307
D14542	231	D14722	196	D14857	139, 147, 219	R12576	307
D14543	231	D14724	254	D14858	219	R12931	15
D14544	231	D14725	254	D14879	196	R12934	15
D14545	231	D14726	254	D14880	219	R14173	310
D14546	231	D14727	256	D14882	277	R14338	311
D14547	232	D14728	256	D14884	147	R14339	311
D14548	232	D14729	256	D14885	147	R14364	139, 180
D14549	233	D14730	256	D14900	285	R14407	305
D14550	233	D14731	256	D14901	285	R14412	311
D14551	233	D14732	257	D14902	285	R14413	301
D14552	232	D14733	257	D14903	284	R14416	311
D14553	232	D14734	257	D14904	284	R14418	310
D14554	232	D14735	257	D14905	279	R14426	310
D14555	220	D14736	257	D14906	277	SHD 8000 LED	228
D14556	220	D14737	258	D14915	281		
D14557	234	D14738	258	D14916	282		
D14558	234	D14739	258	D14922	270		
D14565	263	D14740	258	D14925	269		
D14566	263	D14741	258	D14926	269		
D14567	249	D14742	258	D14928	270		
D14568	249	D14743	235	D14929	270		
D14569	249	D14744	235	D14930	270		
D14574	295	D14745	235	D14931	270		
D14575	295	D14746	259	D14932	270		
D14576	297	D14747	254	D14933	270		
D14577	296	D14748	260	D14934	270		

# N° d'homologation - Homologation number - Homologationsnummer

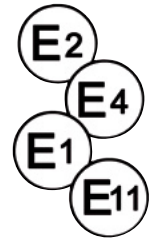

E2	253	MILI	175	E2	86710	FE87	194
E13	697	FRR	176	E2	86711	FE87	205
E13	698	FRR	176	E2	88017	LC7	166
E2	781	FE80	195	E2	88033	LC6	170
E9	1084	672	201	E2	88034	LC6	170
E2	1295	SMD00	198	E2	88035	LC7	167
E1	1559	BBS516	175	E2	88714	FE88	211
E2	2040	LC8	152	E2	88731	MILI	175
E13	2060	725	172	E2	90711	FE81	188
E2	2065	SMD98	203	E2	91098	LC4	171
E3	2617	2751	181	E2	91099	LC4	171
E4	4052	FRR	149	E2	91715	FE80	195
E2	4054	FPL93	200	E2	92057	FM91	59
E2	4088	FE98	192	E2	92058	FM91	59
E2	4089	FE98	192	E2	92059	FM91	59
E2	4090	FE94	203	E2	92060	FM91	59
E2	4091	FE94	203	E2	92061	FM91	59
E2	4092	FE94	198	E2	92062	FM91	59
E2	4093	FE98	198	E13	0001	R104	215
E2	4701	FE87	201	E13	0002	R104	215
E2	4703	FE87	188	E2	0050	C199	183
E2	5047	ICDL94	187	E11	010002	R70	214
E2	5052	FE95	193	E24	020078	FE12	211
E2	5126	FE95	205	E20	020889	DX	210
E9	6653	FRR	149	E2	04010	SMD98	191
E2	7001	EPP96	181	E2	04075	LC9	160
E2	7001	EPP98	181	E2	05010	FE04	190
E2	7102	FE02	193	E2	05011	FE04	202
E2	7139	ICDL94	187	E2	05021	SMD04	196
E11	7573	2963	220	E2	05022	SMD04	191
E2	8005	LC5	161	E2	05023	SMD04	202
E2	8040	SMD98	197	E2	06018	C105	183
E13	8434	725	172	E2	06024	LC5T	164
E2	9033	FE85	187	E2	07089	SH3	220
E2	9036	FE85	205	E2	07092	DXLC8	209
E2	9037	FE85	194	E2	08028	SRD07	185
E2	9056	LC7T	169	E2	09025	ICDL07	186
E2	10035	DX	210				
E2	10073	SRD08	185				
E2	10113	LC9 LED	142				
E13	10989	BX868	180				
E2	11017	EPP96LED	180				
E2	11128	ICDL10	186				
E9	11734	SLIM	148				
E2	12007	LC8	150				
E2	12056	C105	183				
E2	12164	LC10 LED	143				
E4	13992	FRR	149				
E2	14010	DX	207				
E2	14085	LC11	140				
E2	14086	LC11	140				
E2	16005	CTL15	144				
E2	16007	BL15	144				
E2	16027	LC12 LED	138				
E2	16059	ICDL15	186				
E2	16111	CTL14	148				
E2	18042	LC12G LED	138				
E2	19014	LPL18	179				
E2	19106	LCR19	146				
E2	19140	SL1000	219				
E2	20078	RL1500	219				
E4	23271	FRR	149				
E3	38553	2711	177				
E2	5108	MILI	175				
E13	51788	725	173				
E1	53329	BBS516	175				



## Index images - pictures - Abbildung

### Feux arriere - Rear lamps - Heckleuchten

p. 137-177

---



### Eclaireurs de plaque - Number plate lamps - Kennzeichenleuchten

p. 178-181

---



### Feux clignotants - Flasher lamps - Fahrtrichtungsanzeiger

p. 182-188

---



### Feux de position - Position lamps - Positionsleuchten

p. 189-205

---



## Feux de gabarits - End outline marker lamps - Begrenzungsleuchten

p. 206-212



## Signalisation passive - Warning products - Warnmarkierungen

p. 213-217

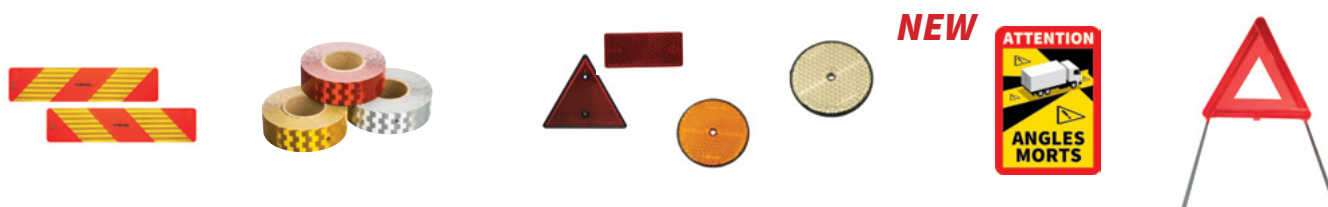

## Phares de recul - Reverse work lights - Rückfahrlicht Arbeitsscheinwerfer

p. 218-220



## Phares de travail - Work lights - Arbeitsscheinwerfer

p. 221-237



## Index images - pictures - Abbildung

### Éclairage de sécurité - Warning lights - Sicherheitsbeleuchtungen

p. 238-239

---



### Phares de conduite - Headlights - Fahrlichter

p. 240-244

---

**NEW**



### Feux auxiliaires - Auxiliary lights - Zusatzsscheinwerfer

p. 245-247

---



### Éclairage intérieur - Interior lights - Innenraum-Beleuchtungen

p. 248-250

---



**NEW**



## Gyrophares - Beacons - Rundumkennleuchten

p. 251-263

---



## Rampes lumineuses - Lightbars - Warnbalken

p. 264-267

---

**NEW**

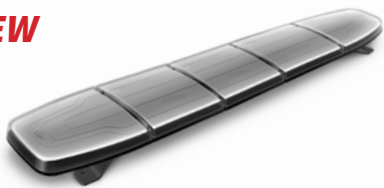

## Triflash

p. 268-270

---



## Feux de pénétration - Directional lights - Warnleuchten

p. 271-272

---



## Index images - pictures - Abbildung

### Alarmes sonores de recul - Back-up alarms - Rückfahrwarner

p. 273-274

Standard



Multi-Frequency



### Systemes caméras - Camera systems - Kamera-Systeme

p. 275-290



### Coffres porte extincteur - Extinguisher boxes - Feuerlöscherbehälter

p. 291-292



### Produits électriques-électroniques - Electrical-electronic products - Elektrisch-elektronische Produkte

p. 293-318



---

**MISE EN GARDE SUR LES RISQUES JURIDIQUES DE LA CONTREFAÇON**  
**WARNING ON LEGAL RISKS OF ORIGINAL PARTS COPIES / FORGERY**  
**HINWEIS AUF DIE RECHTLICHEN RISIKEN BEI FER VERWENDUNG**

---

**MISE EN GARDE SUR LES RISQUES JURIDIQUES DE LA CONTREFAÇON DES PIÈCES D'ORIGINE**

Les **remplacements** ou **modifications** de composants autres que ceux montés et recommandés par le constructeur peuvent remettre en cause la sécurité des usagers de la route (diminution des performances photométriques).

Ex : **Le montage d'un cabochon adaptable sur un feu d'origine Vignal est interdit.**

Toute opération de ce type sur le matériel sera **à la charge entière de celui qui sera intervenu** et pourra **remettre en cause** l'homologation du véhicule délivrée par les autorités compétentes.

Le fabricant dégage sa responsabilité réglementaire.

**La contrefaçon et la concurrence déloyale de pièces sont condamnées par la loi civile et pénale :**

- La contrefaçon engage la responsabilité civile et pénale du fabricant, du revendeur, voire dans certains cas de l'utilisateur des pièces de contrefaçon.

- La concurrence déloyale engage la responsabilité civile du fabricant et du revendeur de copies serviles; en tirant de cette opération un avantage injustifié, **il fausse les règles normales de la concurrence** et réalise de ce fait **un acte de parasitisme** en détournant le travail de recherche et de conception, ainsi que le savoir-faire des constructeurs.

---

**WARNING ON LEGAL RISKS OF ORIGINAL PARTS COPIES / FORGERY**

The **remplacements** or **modifications** of components other than those assembled and recommended by the manufacturer can reduce the safety of the road users (reduction in the photometric performances).

Ex : **The assembly of an adaptable lens on an original lamp Vignal is prohibited.**

Any operation of this type on the material **will be judged as responsibility of who intervened** and will **compromise the homologation of the vehicle** delivered by the authorities.

The manufacturer declines all responsibilities.

**The forgery and the unfair competition of original parts are condemned by the civil and penal law :**

- The forgery engages the civil and penal liability of the manufacturer and the retailer, even in certain cases of the user of the forgery parts.

- The unfair competition engages the civil liability of the manufacturer and the retailer of forged parts; by taking an unjustified advantage from this operation, the forgery **distorts the normal rules** of competition and carries out an **act of parasitism** by diverting the design and R&D task, as well as know-how of the manufacturers.

---

**HINWEIS AUF DIE RECHTLICHEN RISIKEN BEI FER VERWENDUNG VON NACHBAUTEILEN ANSTELLE VON ORIGINALERSATZTEILEN**

Der **Austausch** oder die **Modifikation** von Teilen, die nicht in der Erstausrüstung montiert und vom Hersteller empfohlen wurden, können die Sicherheit der Verkehrsteilnehmer beeinträchtigen (Verringerung der lichttechnischen Leistung).

Beispiel: **Die Verwendung einer nachgebauten Lichtscheibe auf einer VIGNAL-Heckleuchte ist nicht zulässig.**

Jede Verwendung dieses Materials wird **zu Lasten des Verwenders** ausgelegt und kann die **Zulassung des Fahrzeugs durch die Zulassungsstellen in Frage stellen.**

Der Fahrzeughersteller entzieht die gesetzliche Gewährleistungspflicht.

**Die Fälschung (Nachbau) von Originalteilen und der unlautere Wettbewerb werden durch das Zivil- und Strafrecht verurteilt:**

- Die Fälschung (Nachbau) von Originalteilen zieht die zivil- und strafrechtliche Haftung des Herstellers, des Wiederverkäufers und in bestimmten Fällen auch des Benutzers nach sich.

- Der unlautere Wettbewerb zieht **die zivilrechtliche Haftung des Herstellers und des Wiederverkäufers von Nachbauteilen nach sich**; sie ziehen aus dieser Operation einen ungerechtfertigten Nutzen, und verfälschen die normalen Regeln des Wettbewerbs, indem sie die Forschungs- und Konzeptionsarbeit sowie das Know-How der Konstrukteure nutzen.

---

## NORMES ET RÈGLEMENTATION

### STANDARDS AND REGULATIONS

### NORM UND REGLEMENTIERUNG

---

Les extraits de réglementation sont disponibles sur notre site web.

Les éléments sont extraits du règlement ECE R48 concernant la majorité des véhicules.  
Se référer au règlement pour des configurations particulières.

Les produits doivent être homologués selon le dernier amendement en vigueur  
L'utilisateur est responsable de la conformité de l'équipement de son véhicule.

VIGNAL s'engage sur la conformité de ses produits.

ADR

Le sigle ADR signifie que le produit est homologué pour le montage sur des véhicules qui satisfont aux dispositions ADR (accord européen relatif au transport international des marchandises dangereuses par route).

Les produits ADR ont un indice de protection d'au moins IP54.

L'indice de protection IP détermine le degré de protection du matériel contre la pénétration des corps solides (1er chiffre) et des liquides (2ème chiffre).



Exemple : IP54

1er chiffre : 5 => Protégé contre les infiltrations de poussière

2ème chiffre : 4 => Protégé contre les projections d'eau (haute pression) de toutes les directions

---

The regulation extracts are available on our website.

The elements are extracts from the ECE R48 regulation which concern most of the vehicles.  
Please refer to the regulation for any special configuration.

The products must be homologated according to the last amendments in force.  
The user is responsible for the conformity of its vehicle's equipment.

VIGNAL is committed to the conformity of its products

ADR

The ADR sign means the product is homologated on vehicles which are under ADR regulations (European Agreement concerning the International Carriage of Dangerous Goods by Road).

The ADR products have an ingress protection rating of at least IP54.

IP Code classifies and rates the degrees of protection provided against the intrusion of solid objects (1st number) and water (2d number)



Example : IP54

1st number : 5 => Protected against dust

2d number : 4 => Protected against splashing water from all directions

---

Auszüge aus der Reglementierung sind auf unserer Webseite ersichtlich.

Es handelt sich um die für die meisten Fahrzeuge zutreffenden Auszüge der Reglementierung ECE R48.  
Für Sonderfälle sehen Sie bitte die komplette Reglementierung ein.

Die Produkte sind nach dem aktuellstem Änderungsstand zu homologieren.  
Der Fahrzeugführer ist für die zulässige Ausrüstung seines Fahrzeuges verantwortlich.

VIGNAL garantiert die Konformität der Produkte.

ADR

Das ADR Zeichen bedeutet, dass das Produkt für den Einbau in Fahrzeuge mit ADR Zulassung (Europäisches Übereinkommen über die internationale Beförderung gefährlicher Güter auf der Straße) geeignet ist. ADR-Produkte haben einen Schutzfaktor von mindestens IP54.

Der IP Schutzfaktor bestimmt den Schutzgrad eines Bauteils gegenüber das Eindringen von festen Körpern (erste Ziffer) und von Flüssigkeiten (zweite Ziffer).



Beispiel : IP 54

Erste Ziffer : 5 => Schutz gegen das eindringen von Staub

Zweite Ziffer : 4 => Schutz gegen Spritzwasse aus allen Richtungen

**NORMES ET RÈGLEMENTATION**  
**STANDARDS AND REGULATIONS**  
**NORM UND REGLEMENTIERUNG**

**Indice de protection**

Indice	1 <sup>er</sup> chiffre (dizaine) = Protection contre la poussière	2 <sup>ème</sup> chiffre (unité) = Protection contre l'eau
0	Aucune protection.	Aucune protection.
1	Protégé contre les corps solides supérieurs à 50 mm.	Protégé contre les chutes verticales de gouttes d'eau.
2	Protégé contre les corps solides supérieurs à 12,5 mm.	Protégé contre les chutes de gouttes d'eau jusqu'à 15° de la verticale.
3	Protégé contre les corps solides supérieurs à 2,5 mm.	Protégé contre l'eau en pluie jusqu'à 60° de la verticale.
4	Protégé contre les corps solides supérieurs à 1 mm.	Protégé contre les projections d'eau de toutes directions.
5	Protégé contre les poussières.	Protégé contre les jets d'eau de toutes directions à la lance.
6	Totalement protégé contre les poussières.	Protégé contre les forts jets d'eau de toutes directions à la lance.
7	-	Protégé contre les effets de l'immersion (jusqu'à 1m).
8	-	Matériel submersible dans des conditions spécifiées (immersion prolongée) au delà de 1 m et pendant 30 minutes.
9K	-	Protection contre le nettoyage à haute pression.

**International Protection**

Level	1 <sup>st</sup> digit = Solid particles protection	2 <sup>nd</sup> digit = Liquid ingress protection
0	Not protected.	Not protected.
1	Protected against solid objects superior to 50 mm.	Protected against vertical dripping.
2	Protected against solid objects superior to 12,5 mm.	Protected against dripping (inclined 15°).
3	Protected against solid objects superior to 2,5 mm.	Protected against spraying water.
4	Protected against solid objects superior to 1 mm.	Protected against splashing of water from any direction.
5	Dust protected.	Protected against water jets by a nozzle.
6	Dust tight.	Protected against powerful water jets by a nozzle.
7	-	Protected against immersion up to 1 m.
8	-	Submersible equipment under specified conditions beyond 1 m for 30 minutes.
9K	-	Protected against close-range high pressure.

**Schutzart**

Kennziffer	Erste Kennziffer = Schutz gegen Fremdkörper	Zweite Kennziffer = Bedeutung: Schutz gegen Wasser
0	kein Schutz.	kein Schutz.
1	Geschützt gegen feste Fremdkörper mit Durchmesser ab 50 mm.	Schutz gegen Tropfwasser.
2	Geschützt gegen feste Fremdkörper mit Durchmesser ab 12,5 mm.	Schutz gegen fallendes Tropfwasser, wenn das Gehäuse bis zu 15° geneigt ist.
3	Geschützt gegen feste Fremdkörper mit Durchmesser ab 2,5 mm.	Schutz gegen fallendes Sprühwasser bis 60° gegen die Senkrechte.
4	Geschützt gegen feste Fremdkörper mit Durchmesser ab 1,0 mm.	Schutz gegen allseitiges Spritzwasser.
5	Geschützt gegen Staub in schädigender Menge.	Schutz gegen Strahlwasser (Düse) aus beliebigem Winkel.
6	Staubdicht.	Schutz gegen starkes Strahlwasser.
7	-	Schutz gegen zeitweiliges Untertauchen.
8	-	Schutz gegen dauerndes Untertauchen.
9K	-	Schutz gegen Wasser bei Hochdruck-/Dampfstrahlreinigung, spezifisch für Straßenfahrzeuge.







# 2021



**NBB**

**ABL**

**VIGNAL**

**CEA**

**SACEX**

## VIGNAL GROUP

19, avenue du 24 Août 1944  
69960 Corbas  
FRANCE

E-mail : [contact@vignal-group.com](mailto:contact@vignal-group.com)  
Site web : [www.vignal-group.com](http://www.vignal-group.com)

**VIGNAL SYSTEMS**  
19, avenue du 24 Août 1944  
69960 Corbas  
FRANCE

**VIGNAL ABL**  
3, rue de la Cotonnière  
Z.I. du Chemin Vert  
14000 Caen  
FRANCE

**VIGNAL C.E.A.**  
11, Via Alla Rossa  
6862 Rancate  
SWITZERLAND

**VIGNAL CHANGZHOU**  
Building B2, N° 585  
Huanghe West Road  
Xinbei District  
Changzhou City, Jiangsu Province  
CHINA

**VIGNAL ABL USA**  
660 Golf Club Blvd  
Mosinee, WI 54455  
USA



Ref: 99999CAD



[www.vignal-group.com](http://www.vignal-group.com)